

Sfere e spinotti

Balls and pins

35



RE-ALL

Schema ribaltabile

Folding scheme

SENSO DI MARCIA
DIRECTION OF TRAVEL

Sfera laterale con foro per
spinotto ad 1 gola
*Raw ball side with eyelet
for single fluted
locking pin*

Sfera laterale con foro per
spinotto ad 2 gole
*Raw ball side with eyelet
for Twin fluted
locking pin*

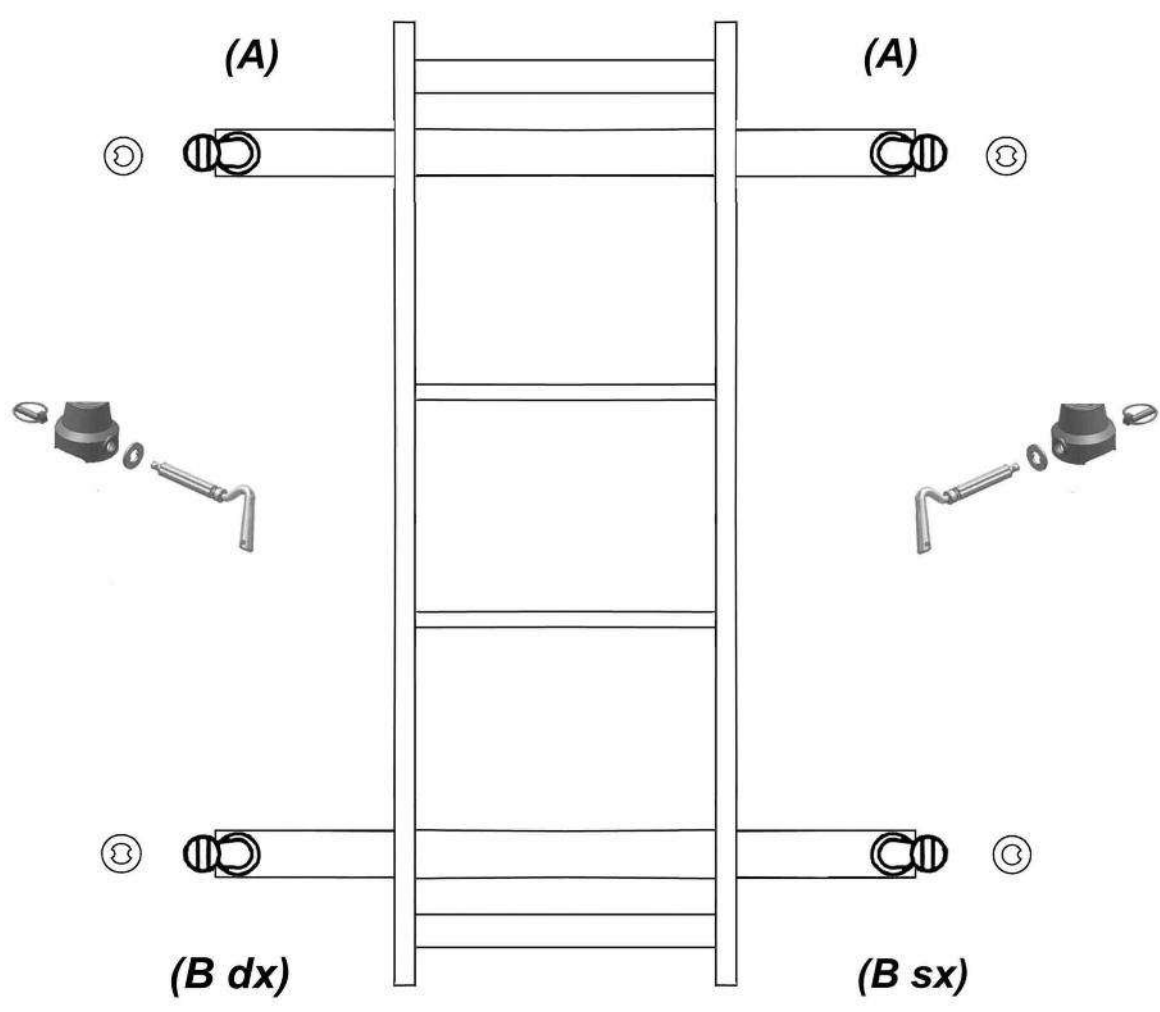

Sfera posteriore con asola
per spinotto a 2 gole
*Raw ball back with oval
eyelet for Twin fluted
locking pin*

Sfera posteriore con asola
per spinotto ad 1 gola
*Raw ball back with oval
eyelet for single fluted
locking pin*

BALLS AND PINS

Art. 35-00000/M	
35-00000	4
35-00000/1	2
35-00000/2	2
35-00004	1
35-00005	2
35-00006	1
35-00007	2
35-00008	2

KIT SFERE PER 1 VEICOLO D.60 AMBIDESTRA
COMPLETE SET FOR VEHICLE D.60 AMBIDEXTROUS

Portata Max Kg. 2000 <g. 2000 Load cap.2000 kg. Max

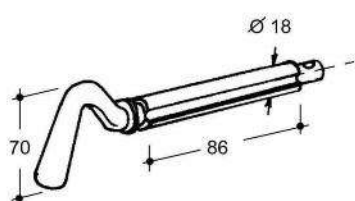

Art. 35-00004
 Spinotto a 1 gola D.18
Single fluted locking pin D.18
 (Kg.0,301)



Art. 35-00005
 Piastrina a 1 gola
Single fluted raw plate
 (Kg.0,017)

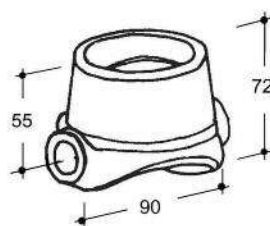

Art. 35-00000
 Supporto a sfera D.60 forgiato
Raw socket for ball D.60 forged
 (Kg.1,290)

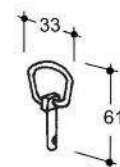

Art. 35-00008
 Coppiglia D.4,5
Cotter pin D.4,5
 (Kg.0,007)

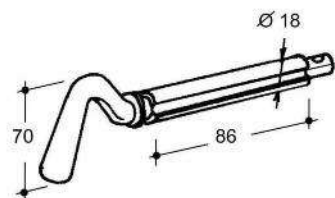

Art. 35-00006
 Spinotto a 2 gole D.18
Twin fluted locking pin D.18
 (Kg.0,302)

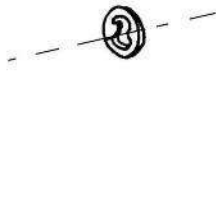

Art. 35-00007
 Piastrina a 2 gole
Twin fluted raw plate
 (Kg.0,017)

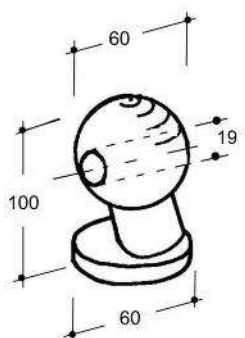

Art. 35-00000/1
 Sfera con foro Ø60
 forgiata
*Raw ball Ø60
 with eyelet forged*
 (Kg.1,243)

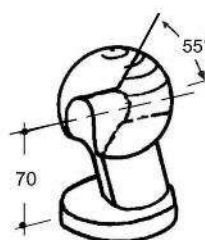

Art. 35-00000/2
 Sfera con asola D.60
 ambidestra
*Raw ball D.60
 with oval eyelet noth side*
 (Kg.1,122)

(A)

(B)

Art. 35-00001/M	
35-00001	4
35-00002	2
35-00003	1
35-00003/SX	1
35-00004	1
35-00005	2
35-00006	1
35-00007	2
35-00008	2

KIT SFERE PER 1 VEICOLO D.60 COMPLETE SET FOR VEHICLE D.60

Portata Max Kg. 2000 Load cap.2000 kg. Max

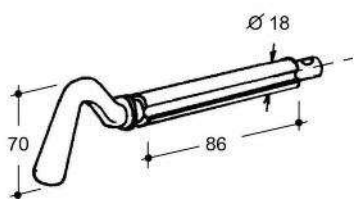

Art. 35-00004
Spinotto a 1 gola D.18
Single fluted locking pin D.18
(Kg.0,301)



Art. 35-00005
Piastrina a 1 gola
Single fluted raw plate
(Kg.0,017)

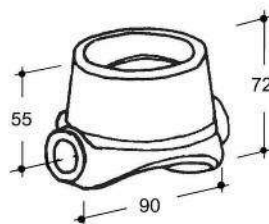

Art. 35-00001
Supporto a sfera D.60
Raw socket for ball D.60
(Kg.1,290)

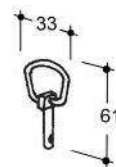

Art. 35-00008
Coppiglia D.4,5
Cotter pin D.4,5
(Kg.0,007)

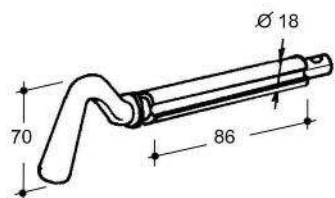

Art. 35-00006
Spinotto a 2 gole D.18
Twin fluted locking pin D.18
(Kg.0,302)



Art. 35-00007
Piastrina a 2 gole
Twin fluted raw plate
(Kg.0,017)

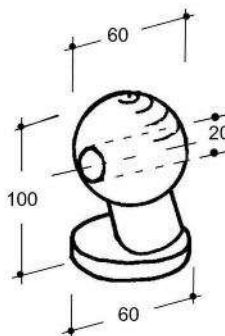

Art. 35-00002
Sfera con foro Ø60
Raw ball Ø60
with eyelet
(Kg.1,243)

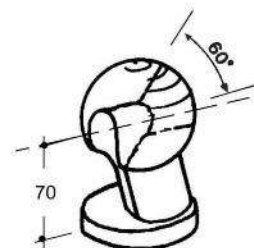

Art. 35-00003
Sfera con asola DX D.60
Raw ball D.60
with oval eyelet - right
(Kg.1,122)

Art. 35-00003/SX
Sfera con asola SX D.60
Raw ball D.60
with oval eyelet - left

(A)

(B sx)

Art. 35-00009/M	
35-00009	4
35-00010	2
35-00011	1
35-00011/SX	1
35-00004/L	1
35-00005	2
35-00006/L	1
35-00007	2
35-00008	2

KIT SFERE PER 1 VEICOLO D.75
COMPLETE SET FOR VEHICLE D.75

Portata Max Kg. 5000 Load cap. 5000 kg. Max

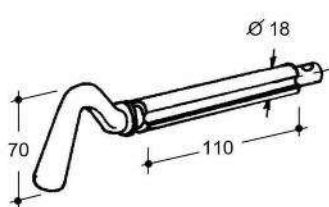

Art. 35-00004/L
 Spinotto a 1 gola D.18
 L=110
 Single fluted locking pin
 L=110 D.18
 (Kg.0,380)

Art. 35-00005
 Piastrina a 1 gola
 Single fluted raw plate
 (Kg.0,017)

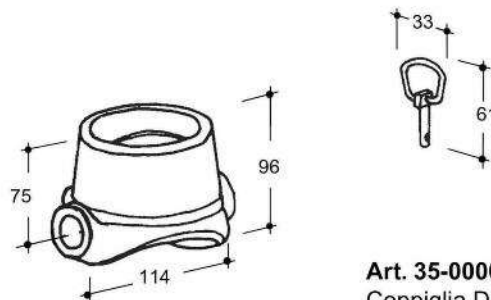

Art. 35-00009
 Supporto a sfera D.75
 Raw socket for ball D.75
 (Kg.2,555)

Art. 35-00008
 Coppiglia D.4,5
 Cotter pin D.4,5
 (Kg.0,007)

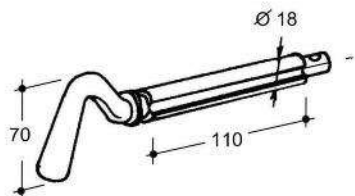

Art. 35-00006/L
 Spinotto a 2 gole D.18
 L=110
 Twin fluted locking pin
 L=110 D.18
 (Kg.0,365)

Art. 35-00007
 Piastrina a 2 gole
 Twin fluted raw plate
 (Kg.0,017)

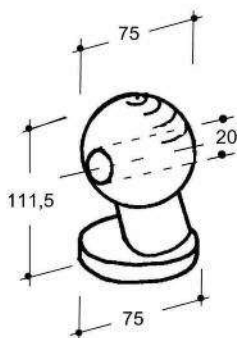

Art. 35-00010
 Sfera con foro D.75
 Raw ball D.75
 with eyelet
 (Kg.2,160)

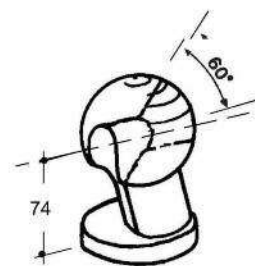

Art. 35-00011
 Sfera con asola DX D.75
 Raw ball D.75 with oval
 eyelet - right
 (Kg.1,900)

Art. 35-00011/SX
 Sfera con asola SX D.75
 Raw ball D.75 with oval
 eyelet - left

(A)

(B sx)

Art. 35-00012/M	
35-00012	4
35-00013	2
35-00014	1
35-00014/SX	1
35-00015	1
35-00016	2
35-00017	1
35-00018	2
35-00019	2

KIT SFERE PER 1 VEICOLO D.85
COMPLETE SET FOR VEHICLE D.85

Portata Max Kg. 15000 Load cap.15000 kg. Max

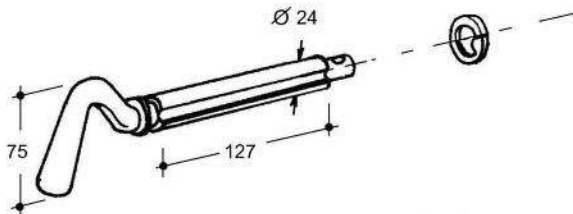

Art. 35-00015
 Spinotto a 1 gola D.24
 Single fluted locking pin D.24
 (Kg.0,714)

Art. 35-00016
 Piastrina a 1 gola
 Single fluted raw plate
 (Kg.0,026)

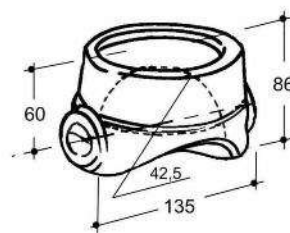

Art. 35-00012
 Supporto a sfera D.85
 Raw socket for ball D.85
 (Kg.3,388)

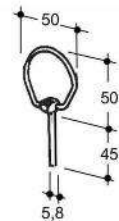

Art. 35-00019
 Coppiglia D.6
 Cotter pin D.6
 (Kg.0,019)

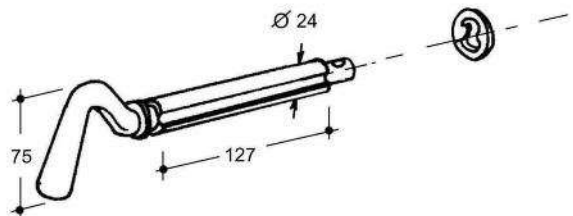

Art. 35-00017
 Spinotto a 2 gole D.24
 Twin fluted locking pin D.24
 (Kg.0,670)

Art. 35-00018
 Piastrina a 2 gole
 Twin fluted raw plate
 (Kg.0,026)

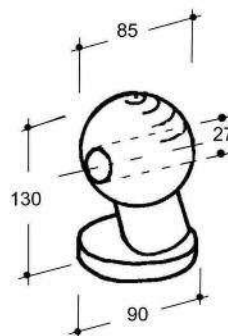

Art. 35-00013
 Sfera con foro D.85
 Raw ball D.85
 with eyelet
 (Kg.3,336)

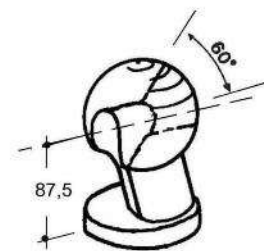

Art. 35-00014
 Sfera con asola DX D.85
 Raw ball D.85
 with oval eyelet - right
 (Kg.3,015)

Art. 35-00014/SX
 Sfera con asola SX D.85
 Raw ball D.85
 with oval eyelet - left

(A)

(B sx)

BALLS AND PINS

Art. 35-00020/M	
35-00020	4
35-00021	2
35-00022	1
35-00022/SX	1
35-00023	1
35-00016	2
35-00024	1
35-00018	2
35-00019	2

KIT SFERE PER 1 VEICOLO D.95
COMPLETE SET FOR VEHICLE D.95

Portata Max Kg. 25000 Load cap. 25000 kg. Max

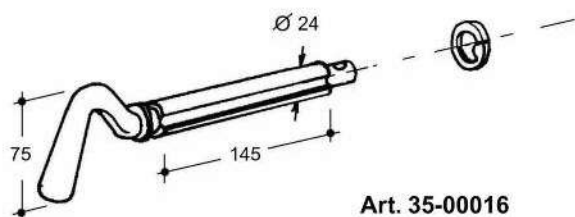

Art. 35-00016
 Piastrina a 1 gola
 Single fluted raw plate
 (Kg.0,026)

Art. 35-00023
 Spinotto a 1 gola D.24
 Single fluted locking pin D.24
 (Kg.0,782)

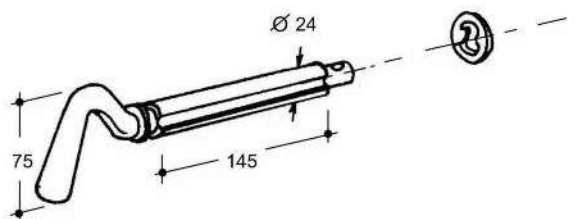

Art. 35-00018
 Piastrina a 2 gole
 Twin fluted raw plate
 (Kg.0,026)

Art. 35-00024
 Spinotto a 2 gole D.24
 Twin fluted locking pin D.24
 (Kg.0,762)

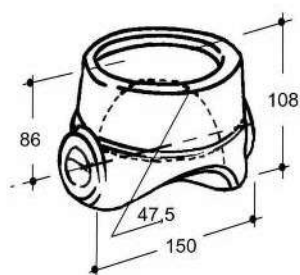

Art. 35-00020
 Supporto a sfera D.95
 Raw socket for ball D.95
 (Kg.5,630)

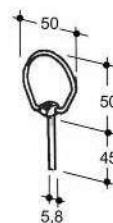

Art. 35-00019
 Coppiglia D.6
 Cotter pin D.6
 (Kg.0,019)

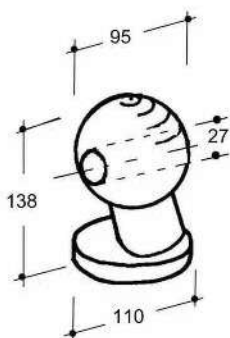

Art. 35-00021
 Sfera con foro D.95
 Raw ball D.95
 with eyelet
 (Kg.4,810)

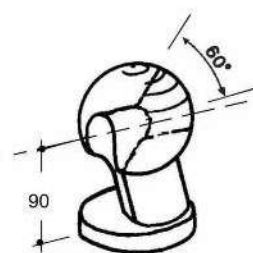

Art. 35-00022
 Sfera con asola DX D.95
 Raw ball D.95 with
 oval eyelet - right
 (Kg.4,630)

Art. 35-00022/SX
 Sfera con asola SX D.95
 Raw ball D.95 with
 oval eyelet - left

(A)

(B sx)

Art. 35-00030/M	
35-00030	4
35-00031	2
35-00032	1
35-00032/SX	1
35-00033	1
35-00034	2
35-00035	1
35-00036	2
35-00019	2

KIT SFERE PER 1 VEICOLO D.110
COMPLETE SET FOR VEHICLE D.110

Portata Max Kg. 45000 Load cap.45000 kg. Max

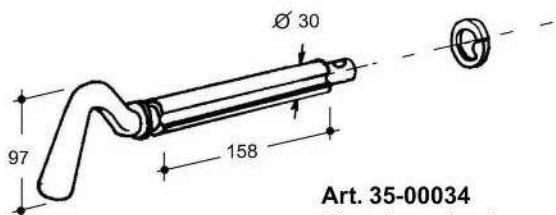

Art. 35-00034
 Piastrina a 1 gola
 Single fluted raw plate

Art. 35-00033
 Spinotto a 1 gola D.30
 Single fluted locking pin D.30
 (Kg.1,430)

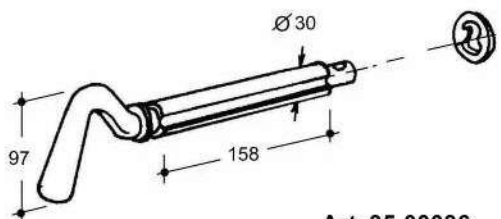

Art. 35-00036
 Piastrina a 2 gole
 Twin fluted raw plate

Art. 35-00035
 Spinotto a 2 gole D.30
 Twin fluted locking pin D.30
 (Kg.1,420)

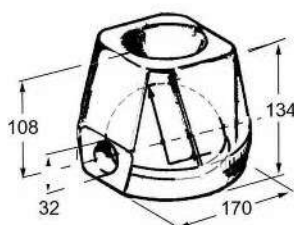

Art. 35-00030
 Supporto a sfera D.110
 Raw socket for ball D.110
 (Kg.9,210)



Art. 35-00019
 Coppiglia D.6
 Cotter pin d. 6
 (Kg.0,019)

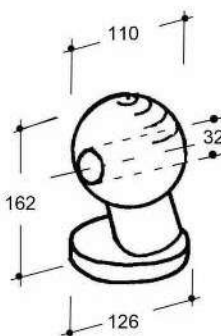

Art. 35-00031
 Sfera con foro D.110
 Raw ball D.110
 with eyelet
 (Kg.8,165)

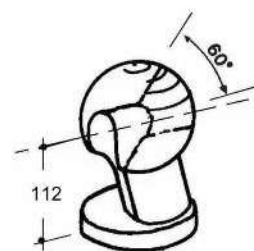

Art. 35-00032
 Sfera con asola DX D.110
 Raw ball d. 110 with
 oval eyelet - right
 (Kg.7,536)

Art. 35-00032/SX
 Sfera con asola SX Ø110
 Raw ball D.110 with
 oval eyelet - left

(A)

(B sx)

KIT per ribaltabile con bocca di lupo e forcella con perno D.22
Complete set three way tipper joint wolf's D.22

Portata Max Kg. 5000

Load cap. 5000 kg. Max

Art. 35-00060/M

35-00064	1
35-00060	2
35-00068	1
35-00066	2
35-00062	4

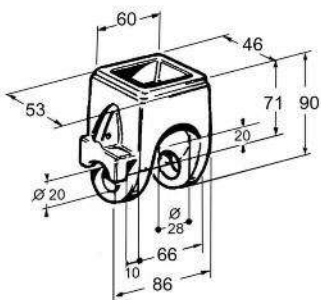

Art. 35-00060

Bocca di lupo "F. U." con foro D.20
 Raw support wolf's with hole D.20

(Kg.1,370)

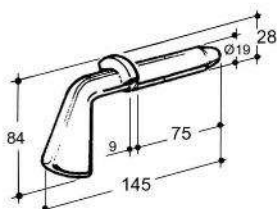

Art. 35-00064

Maniglia "F. U." perno D.19
 Raw locking pin D.19

(Kg.0,350)

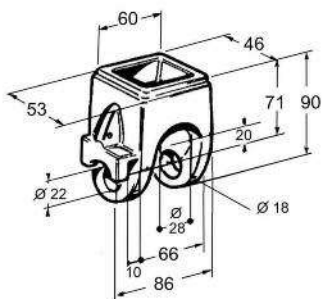

Art. 35-00066

Bocca di lupo "F. D." foro D.22 / D.18
 Raw support wolf's with differentiated hole D.22/D.18

(Kg.1,357)

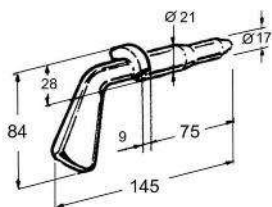

Art. 35-00068

Maniglia "F. D." perno D.21/D.17
 Raw locking pin D.21/D.17

(Kg.0,403)

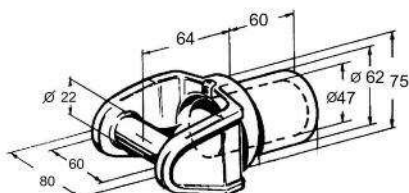

Art. 35-00062

Forcella per bocca di lupo perno D.22
 Raw fork wolf's pin D.22

(Kg.1,585)

KIT per ribaltabile con bocca di lupo e forcella con perno D.30
Complete set three way tipper joint wolf's D.30

Portata Max Kg. 10000

Load cap. 10000 kg. Max

Art. 35-00080/M

35-00084	1
35-00080	2
35-00088	1
35-00086	2
35-00082	4

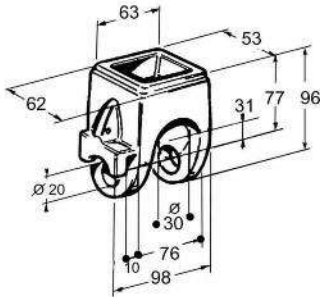

Art. 35-00080

Bocca di lupo "F. U." con foro D.20
Raw support wolf's with hole D.20

(Kg.1,933)

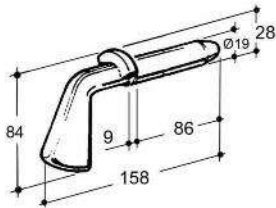

Art. 35-00084

Maniglia "F. U." perno D.19
Raw locking pin d. 19

(Kg.0,426)

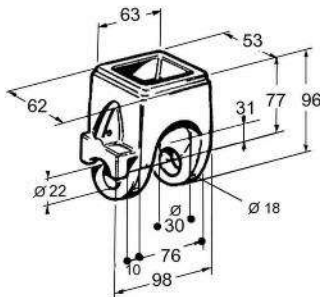

Art. 35-00086

Bocca di lupo "F.D."
 con foro D.18/22
*Raw support wolf's with
 differentiated hole D.18/D.22*

(Kg.1,868)



Art. 35-00088

Maniglia "F. D." perno D.17/D.21
Raw locking pin D.17/D.21

(Kg.0,438)

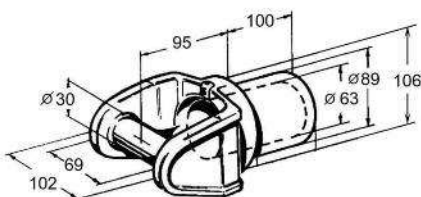

Art. 35-00082

Forcella per bocca di lupo perno D.30
Raw fork wolf's PIN D.30

(Kg.5,334)

Art. 35-00100/M	
35-00100	1
35-00100/SX	1
35-00102	1
35-00102/SX	1
35-00104	4
35-00106	1
35-00108	1
35-00109	4

**KIT SFERE PER 1 VEICOLO D.75 CON PIASTRA
HORIZONTAL COMPLETE SET FOR VEHICLE D.75**

Portata Max Kg. 5000

Load cap. 5000 kg. Max

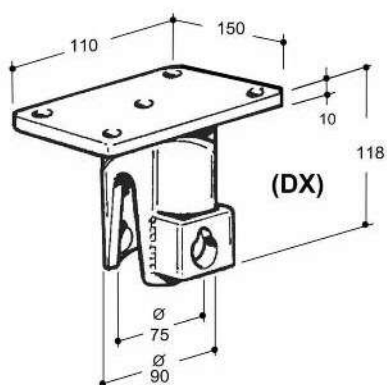
**Art. 35-00100**

Supp.sfera DX zinc.c/piastra - foro D.16,5 1
Galvanized right socket with hole D.16,5

Art. 35-00100/SX

Supp.sfera SX zinc.c/piastra - foro D.16,5 1
Galvanized left socket with hole D.16,5

Art. 35-00102

Supp.sfera DX zinc.c/piastra - foro D.18,5 / D.14,5
Galvanized right socket with hole D.18,5 / D.14,5

Art. 35-00102/SX

Supp.sfera SX zinc.c/piastra - foro D.18,5 / D.14,5
Galvanized left socket with hole D.18,5 / D.14,5

(Kg.1,500)

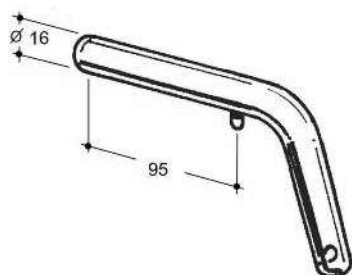
**Art. 35-00106**

Spinotto zinc. D.16
Galvanized locking pin D.16

(Kg.0,320)

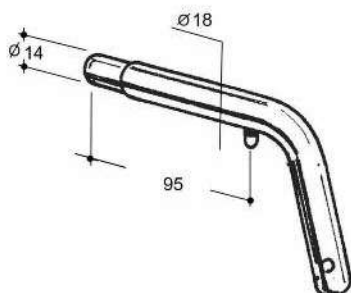
**Art. 35-00108**

Spinotto zinc.D.18 / D.Ø 14
Galv.locking pin D.18 / D.14

(Kg.0,330)

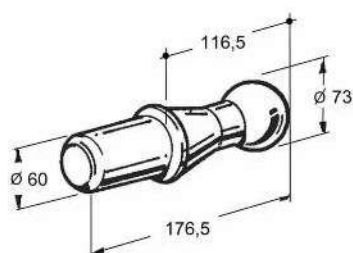
**Art. 35-00104**

Sfera D.73 / Raw ball D.73

(Kg.2,000)

Art. 35-00110/M	
35-00110	1
35-00110/SX	1
35-00112	1
35-00112/SX	1
35-00114	4
35-00116	1
35-00118	1
35-00119	4

KIT SFERE PER 1 VEICOLO D.50 CON PIASTRA
HORIZONTAL COMPLETE SET FOR VEHICLE D.50

Portata Max Kg. 3500 Load cap. 3500 kg. Max

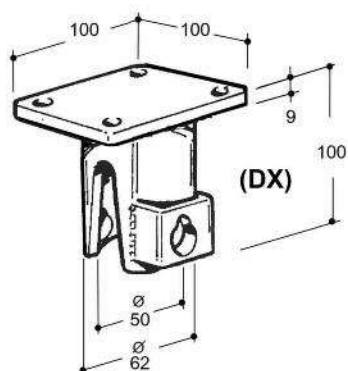

Art. 35-00110

Supp.sfera DX zinc.c/piastra-foro D.14,5
 Galvanized right socket with hole D.14,5

Art. 35-00110/SX

Supp.sfera SX zinc.c/piastra-foro D.14,5
 Galvanized left socket with hole D.14,5

Art. 35-00112

Supp.sfera DX zinc.c/piastra-foro D.16,5 / D.12,5
 Galvanized right socket with hole D.16,5 / D.12,5

Art. 35-00112/SX

Supp.sfera SX zinc.c/piastra-foro D.16,5 / D.12,5
 Galvanized left socket with hole D.16,5 / D.12,5

(Kg.1,500)

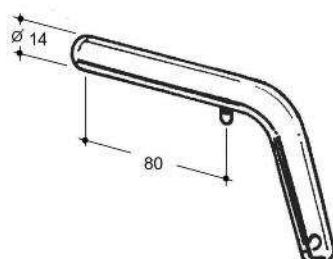

Art. 35-00116

Spinotto zinc. D.14
 Galv. locking pin D.14

(Kg.0,300)

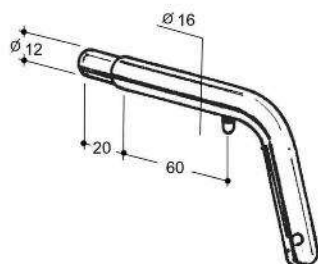

Art. 35-00118

Spinotto zinc. D.16 - D.12
 Galv.locking pin D.16 - D.12

(Kg.0,310)

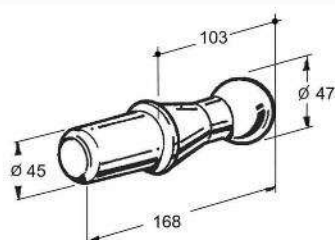

Art. 35-00114

Sfera D.47 / Raw ball D.47

(Kg.0,920)

Accessoristica

Accessories

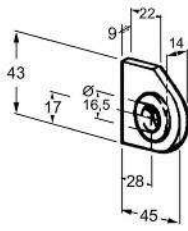
**Art. 35-00040**

Orecchietta tipo "P"/Raw ear type "P"

(Kg.0,098)

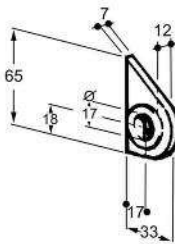
**Art. 35-00042**

Orecchietta tipo "M"/Raw ear type "M"

(Kg.0,082)

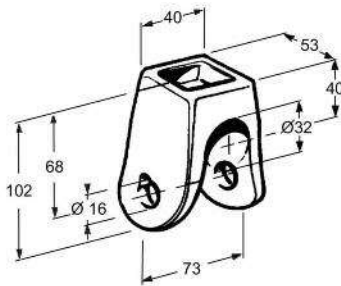
**Art. 35-00044**Cavallotto ribaltabile
Raw forged support for tipper

(Kg.0,820)

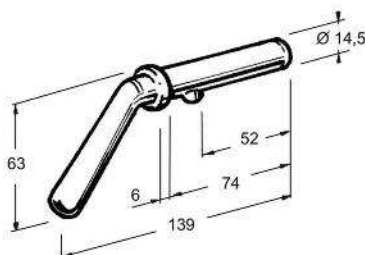
**Art. 35-00046**Chiavistello cavallotto ribaltabile
Raw forged pin for tipper

(Kg.0,203)

Accessoristica

Accessories

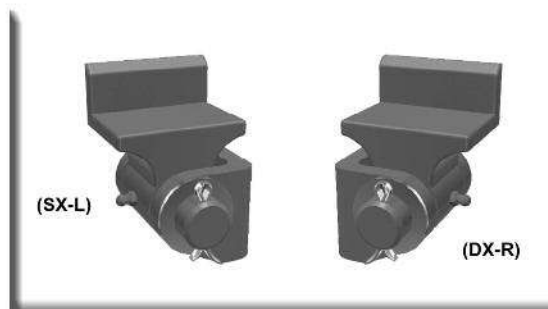
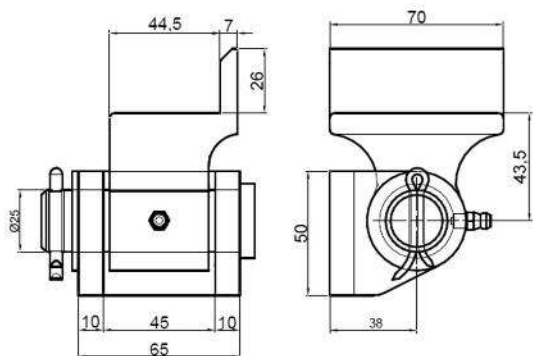

Art. 35-00077/DX Kit ribaltabile posteriore leggero grezzo 3,5 Ton. (DX)
Light rear tilting raw bodies assembly capacity load 3,5 Tons (R)

(Kg.1,610)

Art. 35-00077/SX Kit ribaltabile posteriore leggero grezzo 3,5 Ton. (SX)
Light rear tilting raw bodies assembly capacity load 3,5 Tons (R)

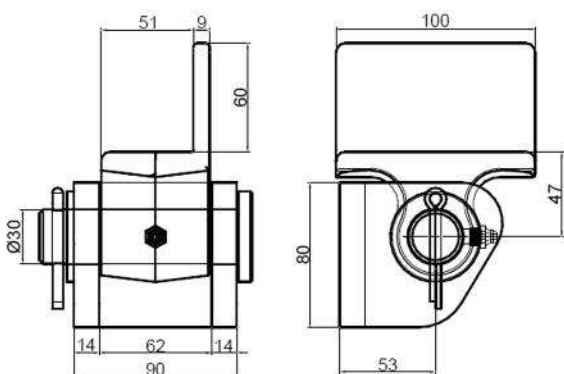

Art. 35-00078/DX Kit ribaltabile posteriore pesante grezzo 5 Ton. (DX)
Heavy rear tilting raw bodies assembly capacity load 5 Tons (R)

(Kg.4,315)

Art. 35-00078/SX Kit ribaltabile posteriore pesante grezzo 5 Ton. (SX)
Heavy rear tilting raw bodies assembly capacity load 5 Tons (R)

