

Tappi - Tamponi Guarnizioni

***Caps - Rubber
buffers - Seals***

49



RE-ALL

BATTISPONDA

BUFFER

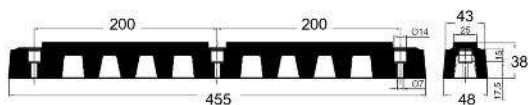

Art. 49-00001 (Kg.0,960)
 Battisponda in gomma L=455 *Black rubber buffer L=455*

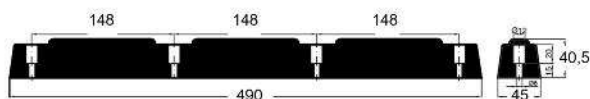

Art. 49-00000 (Kg.0,615)
 Battisponda in gomma L=490 *Black rubber buffer L=490*

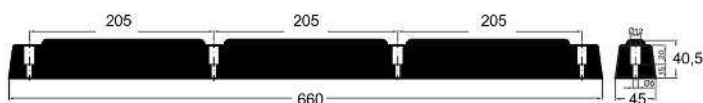

Art. 49-00002 (Kg.1,249)
 Battisponda in gomma L=660 *Black rubber buffer L=660*

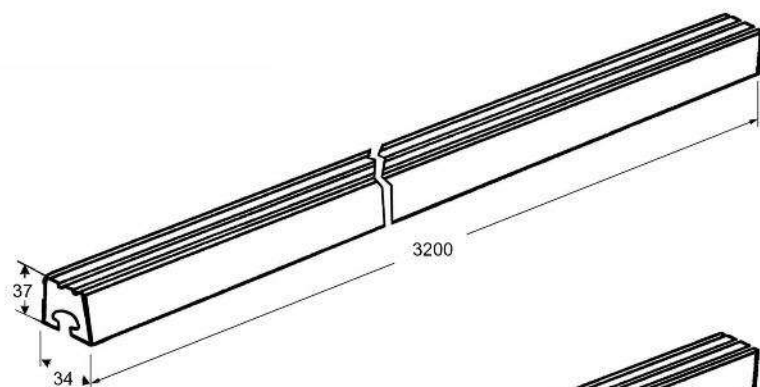

Art. 49-00003
 Battisponda Pvc nero L=3200
Black PVC buffer L=3200
 (Kg.4,500)

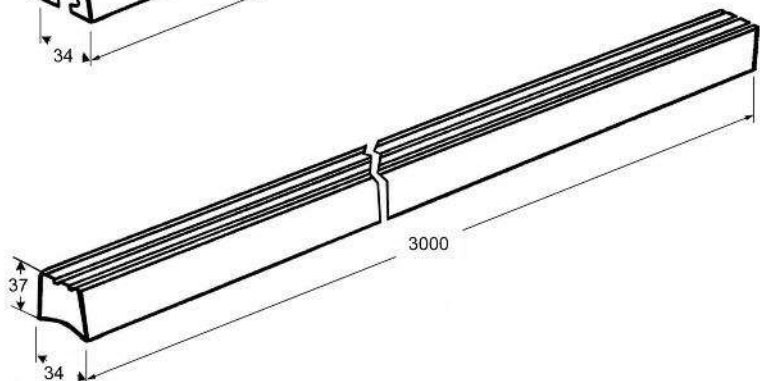

Art. 49-00003/P
 Battisponda Pvc nero (pieno) L=3000
Black PVC buffer (full) L=3000
 (Kg.4,600)

GOMMINI BATTISPONDA

BUFFER

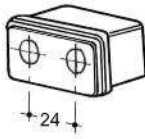
**Art. 49-00004**

(Kg.0,043)

Gommino battisponda int. fori 24 - 50x30xH.30
 Black rubber buffer int.holes 24 - 50x30xH.30

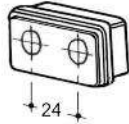
**Art. 49-00006**

(Kg.0,020)

Gommino battisponda int.fori 24 50x30xH.12
 Black rubber buffer int.holes 24 50x30xH.12

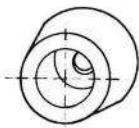
**Art. 49-00008**

(Kg.0,006)

Gommino battisponda D.30 - D.26 - H.13
 Black rubber conical buffer D.30 - D.26 -H.13

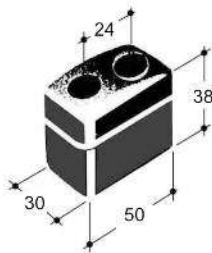
**Art. 49-00005**

(Kg.0,059)

Gommino battisponda bombato int.fori 24 50x30xH.38
 Black rubber buffer int.holes 24 50x30xH.38

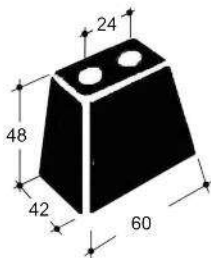
**Art. 49-00007**

(Kg.0,134)

Gommino battisponda int.fori 24 60x42xH.48
 Black rubber buffer int.holes 24 60x42xh.48

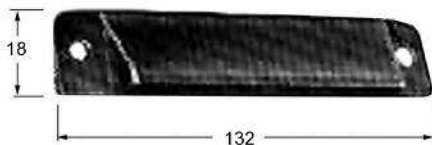
**Art. 49-00044**

(Kg.0,012)

Terminale plastica nera per bandella ferma carico (39-00034/35/36)
 Black plastic endpiece for cargo restraint profile (39-00034/35/36)

**Art. 49-00022**

(Kg.0,113)

Testata in PVC per paraincastri per autocarri
 PVC end cap for underrun protection system

Tappi in PVC

Black PVC cap

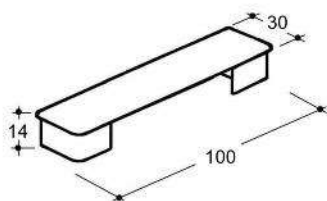

Art. 49-00009

(Kg.0,010)

Tappo per profilo paracicli 100x30

Black PVC cap for aluminium side protection 100x30

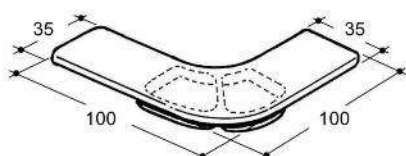

Art. 4900010

(Kg.0,018)

Tappo per profilo curva paracicli 100x30

Black PVC corner cap for aluminium side protection 100x30

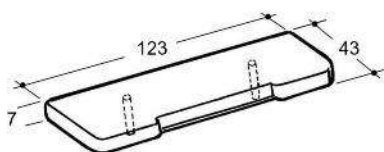

Art. 49-00011

(Kg.0,009)

Tappo per profilo paracicli 120x40

Black PVC cap for aluminium side protection 120x40

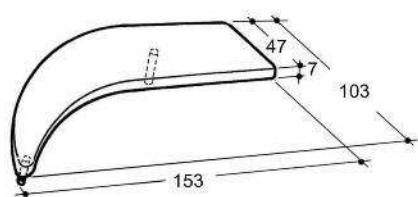

Art. 49-00012

(Kg.0,009)

Tappo per profilo curva paracicli 120x40

Black PVC corner cap for aluminium side protection 120x40

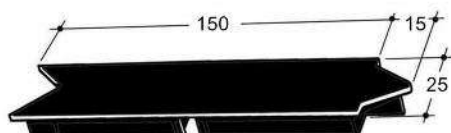

Art. 49-00060

(Kg.0,013)

Tappo in PVC per stecca 150x25

Black PVC cap for aluminium profile 150x25

Tappi in gomma e in pvc

Pvc and rubber caps

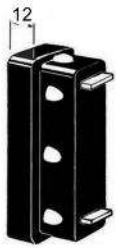
**Art. 49-00013**

(Kg.0,082)

Tappo gomma senza anima per stecca 100x25 c/alette metalliche
Black rubber cap for aluminium profile 100x25 with iron fixed wings

**Art. 49-00015**

(Kg.0,093)

Tappo gomma doppia camera per stecca 120x25 c/alette metalliche
Black rubber cap for aluminium prof. 120x25 with double chamber and iron fixed wings

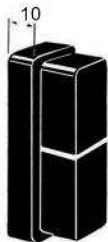
**Art. 49-00024**

(Kg.0,064)

Tappo gomma doppia camera per stecca 100x25
Black rubber cap for aluminium profile 100x25 with double chamber

**Art. 49-00014/A**

(Kg.0,020)

Tappo in PVC alettato per stecca 100x25
Black PVC cap for aluminium profile 100x25

**Art. 49-00016/A**

(Kg.0,020)

Tappo in PVC alettato per stecca 100x30
Black PVC cap for aluminium profile 100x30

Tappi in gomma e in pvc

Pvc and rubber caps

**Art. 49-00093**

(Kg.0,005)

Tappo in PVC alettato per tubo 25x25
Black PVC cap for tube 25x25

**Art. 49-00092**

(Kg.0,009)

Tappo in PVC alettato per tubo 40x30
Black PVC cap for tube 40x30

**Art. 49-00017**

(Kg.0,019)

Tappo in PVC alettato per tubo 60x30x2
Black PVC cap for tube 60x30x2

**Art. 49-00094**

(Kg.0,013)

Tappo in PVC alettato per tubo 80x20
Black PVC cap for tube 80x20

**Art. 49-00090**

(Kg.0,039)

Tappo in PVC alettato per tubo 80x40
Black PVC cap for tube 80x40

**Art. 49-00091**

(Kg.0,042)

Tappo in PVC alettato per tubo 80x80
Black PVC cap for tube 80x80

**Art. 49-00099**

(Kg.0,039)

Tappo in PVC alettato per tubo 70x70
Black PVC cap for tube 70x70

Tappi in gomma e in pvc

Pvc and rubber caps

**Art. 49-00069**

(Kg.0,004)

Tappo in PVC alettato per tubo D.25
Black PVC cap for tube D.25**Art. 49-00073**

(Kg.0,003)

Tappo per testata arrotondata (17-00057)
Corner cap PVC (for art. 17-00057)**Art. 49-00074/DX - Art. 49-00074/SX**

(Kg.0,005)

Tappo per testata arrotondata per minimatic
con doppia camera dx o sx (17-00060)*Corner cap PVC for Mini Matic double Room
right or left (for art. 17-00060)***Art. 49-00072**

(Kg.0,005)

Tappo per Mini Matic III
*PVC cap for MINI Matic III***Art. 49-00078**

(Kg.0,005)

Tappo per Mini Matic open top
PVC cap for MINI Matic open topTappo per staffa parafango PVC per
Black PVC cap for

Art.	tubo D.-tube D.	Kg/cd.
49-00018	54	0,017
49-00019	35	0,008
49-00023	42	0,010

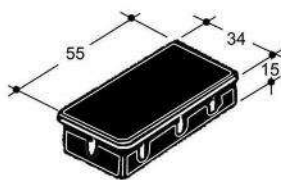
**Art. 49-00020**

(Kg.0,009)

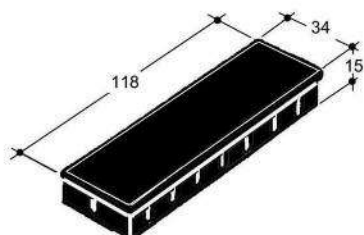
Tappo in plastica per montante anteriore L.56
Black PVC cap for front pillar L.56**Art. 49-00021**

(Kg.0,018)

Tappo in plastica per montante centrale e posteriore L.120
Black PVC cap for rear and central pillar L.120

Tappi e fondelli tubi portamanichette

Hose containers lid and endcap

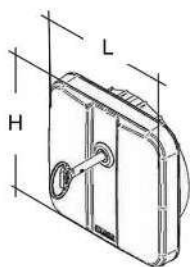

Art. 49-00100 (Kg.0,280)
 Tappo per tubi portamanichette H.195 x L.185 - D.160
 Hose containers lid H.195 x L.185 - D.160

Art. 49-00101
 Tappo per tubi portamanichette H.235 x L.225 - D.200
 Hose containers lid H.235 x L.225 - D.200

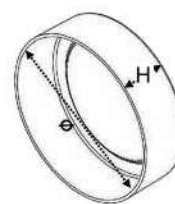

Art. 49-00103
 Fondello per tubi portamanichette H. 40 - D.160
 Hose containers endcap H.40 - D.160

Art. 49-00104
 Fondello per tubi portamanichette H.40 - D.200
 Hose containers endcap H.40 - D.200

Cantonale in PVC

Pvc corner

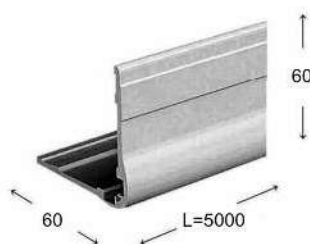

Art. 49-00110 (Kg.a barra 2,570)
 Cantonale in pvc bianco L=5000
 White pvc corner L=5000



Art. 49-00112 (Kg.0,062)
 Blocco d'angolo in pvc bianco per art. 49-00110
 Higher white pvc corner for art.49-00110



Art. 49-00120
 Pomello per leva tenditelo (art.34-00175)
 Knob lever for curtain (art. 34-00175)
 (Kg.0,013)

Paracolpo per maniglia in pvc

Side buffer pvc

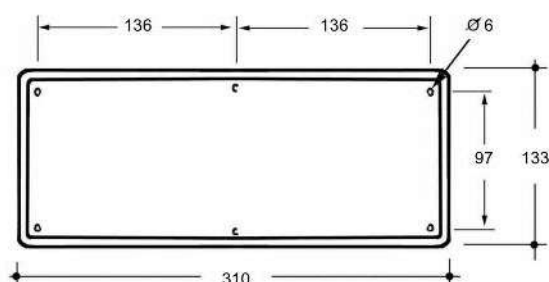

Art. 49-00059 (Kg.0,322)
 Paracolpo per maniglia
 Side buffer

GUARNIZIONI

SEALS

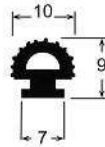
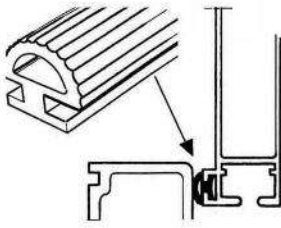

Art. 49-00026 (Kg./mt.0,040)
 Guarnizione sponda per profili
 (17-00026/17-00326/17-00056/17-00058)

Seal for aluminium profiles
 (17-00026/17-00326/17-00056/17-00058)
 (rotolo / roll mt. 200)

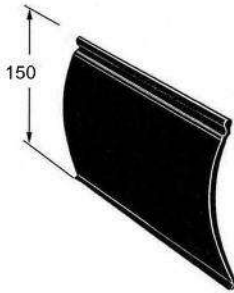

Art. 49-00027 (Kg./mt.0,756)
 Guarnizione in PVC per tegolone
PVC seal for lateral curtain
 (rotolo / roll mt.28)

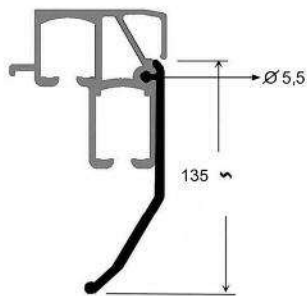

Art. 49-00027/N (Kg./mt.0,700)
 Guarnizione in PVC per tegolone new (21-00058)
PVC seal for lateral curtain new (21-00058)
 (rotolo / roll mt.14)



Art. 49-00027/S (Kg./mt.0,700)
 Guarnizione in PVC per tegolone "S"
PVC seal for lateral curtain "S"
 (rotolo / roll mt.14)

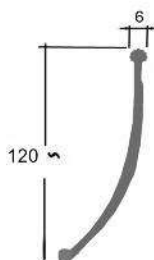

Art. 34-00315 (Kg./mt.0,700)
 Guarnizione in PVC grigia 14 mt.
PVC seal grey 14 mt.
 (rotolo / roll mt.14)

GUARNIZIONI

SEALS

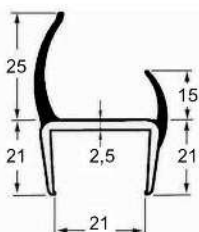
**Art. 49-00028**

Guarnizione in PVC da 21 L=3150
PVC seals da 21 L=3150

(Kg./mt.0,369)

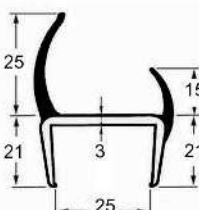
**Art. 49-00029**

Guarnizione in PVC da 25 L=2850 - L=3150
PVC seals da 25 L=2850 - L=3150

(Kg./mt.0,400)

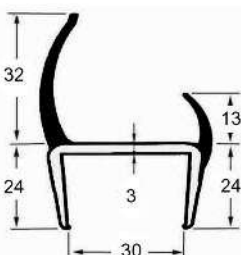
**Art. 49-00030**

Guarnizione in PVC da 30 L=2850 - L=3150
PVC seals da 30 L=2850 - L=3150

(Kg./mt.0,480)

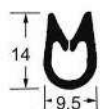
**Art. 49-00033**

Guarnizione GUISNAP
GUISNAP seal

(Kg.0,140)

(rotolo/roll mt.50)

**Art. 49-00034**

Guarnizione GUISNAP con palloncino superiore
GUISNAP seal

(Kg.0,224)

(rotolo/roll mt.50)

**Art. 49-00035**

Guarnizione GUISNAP con palloncino laterale
GUISNAP seal

(Kg.0,232)

(rotolo/roll mt.25)

GUARNIZIONI

SEALS

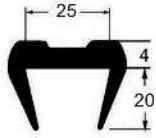
**Art. 49-00025**

(Kg./mt.0,270)

Guarnizione salva sponde serie 25 L=6000
 Profiles for protection of tipper and float
 with tickness 25 - L=6000

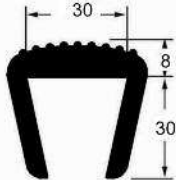
**Art. 49-00089**

(Kg./mt.0,700)

Guarnizione per sponde da 30 L=4000
 Profiles for protection of tipper and float with tickness 30 L=4000

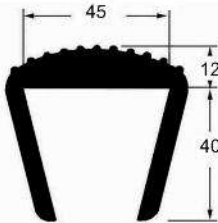
**Art. 49-00084**

(Kg./mt.1,010)

Guarnizione per sponde da 45 L=2500
 Profiles for protection of tipper and float with tickness 45-L=2500

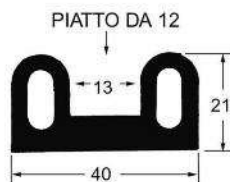
**Art. 49-00040**

(Kg./mt.0,702)

Guarnizione tipo "B"
 Seal "B" type

(rotolo/roll mt.25)

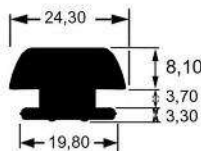
**Art. 49-00098**

(Kg./mt.0,335)

Guarnizione sponda per profili
 Seal for aluminium profiles

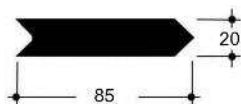
**Art. 49-00063**

(Kg.0,002)

Coprigiunto PVC per guarnizione PVC
 PVC joint for PVC seal

GUARNIZIONI

SEALS

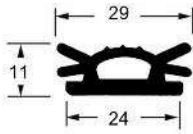
**Art. 49-00031**

Guarnizione per profilo 21-00028
Seal for profile 21-00028

(Kg./mt.0,193)

(rotolo / roll 50mt.)

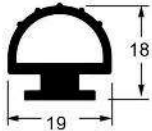
**Art.49-00079**

Guarnizione per profilo 21-00029
Seal for profile 21-00029

(Kg./mt.0,208)

(rotolo / roll 50mt.)

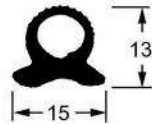
**Art. 49-00032**

Guarnizione per profilo 21-00030
Seal for profile 21-00030

(Kg./mt.0,089)

(rotolo / roll 50mt.)

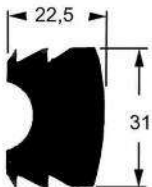
**Art. 49-00043**

Guarnizione per profilo 21-00041
Seal for profile 21-00041

(Kg.mt.0,810)

(rotolo/roll 28 mt.)

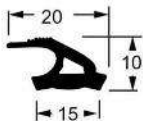
**Art. 49-00083**

Guarnizione per profilo 17-00098
Seal for profile 17-00098

(Kg.mt.0,088)

GUARNIZIONI

SEALS

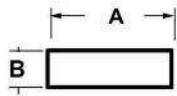

Art.	Guarnizione	Seal	A	B	Rotolo Roll	Kg/mt.
49-00039	Spugna	Seal sponge	15	5	10 mt.	0,015
49-00038	Mouse adesivo	Adhesive seal "Mouse"	15	4	10 mt.	0,010
49-00042	Mouse adesivo	Adhesive seal "Mouse"	20	8	10 mt.	0,028
49-00041	Mouse adesivo	Adhesive seal "Mouse"	50	5	10 mt.	0,045

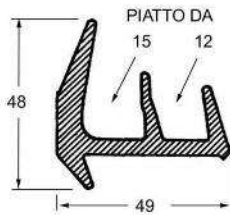
**Art. 49-00036**

Guarnizione gomma a 2 labbra per frigo
 Rubber door profiles for refrigerated body
 (rotolo / roll 25 mt.) (Kg./mt.0,812)

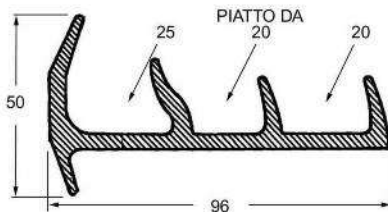
**Art. 49-00037**

Guarnizione gomma a 3 labbra per frigo
 Rubber door profiles for refrigerated body

(Kg./mt.1,037)

(rotolo / roll 15 mt.)

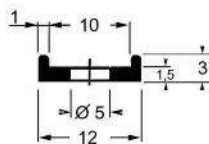
**Art. 49-00087**

Profilo alluminio per fissaggio guarnizioni
 in gomma 12mm. barre L=3000
 Seal fastening profile 12mm. - bars L=3000

(Kg.0,160)

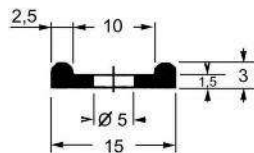
**Art. 49-00088**

Profilo alluminio per fissaggio guarnizioni
 in gomma 15mm. barre L=3000
 Seal fastening profile 15mm - bars L=3000

(Kg.0,220)

**Art. 49-00096**

(Kg./mt.0,050)

Guarnizione per piani mobili
 Seal for moving floor
 (rotolo / roll 150 mt)

**Art. 49-00095**

(Kg.0,053)

Scorrevole per piani mobili
 Sliding for moving floor

Tamponi e Paracolpi

Rubber buffers

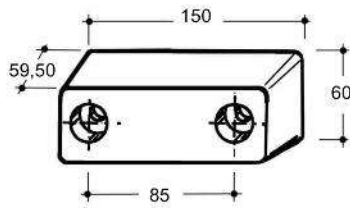

Art. 49-00047

(Kg.0,604)

Tampone in gomma 150x60xH.59,50
 Rubber buffer 150x60xH.59,50

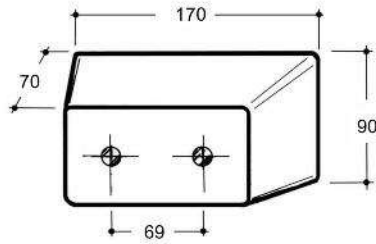

Art. 49-00046

(Kg.1,115)

Tampone in gomma 170x90xH.70
 Rubber buffer 170x90xH.70

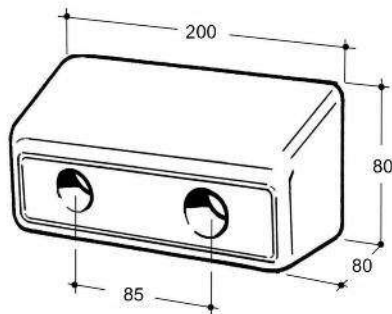

Art. 49-00051

(Kg.1,410)

Tampone in gomma 200x80xH.80
 Rubber buffer 200x80xH.80

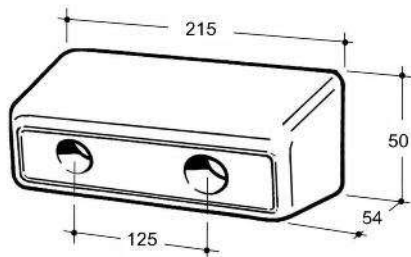

Art. 49-00045

(Kg.0,607)

Tampone in gomma 215x50xH.54
 Rubber buffer 215x50xH.54

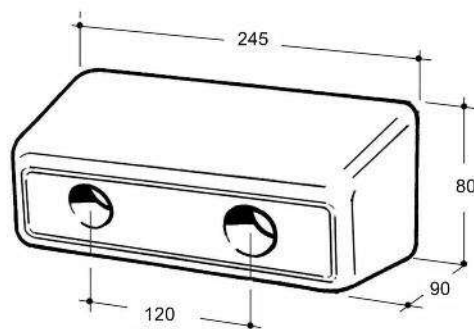

Art. 49-00052

(Kg.1,630)

Tampone in gomma 245x80xH.90
 Rubber buffer 245x80xH.90

Tamponi e Paracolpi

Rubber buffers

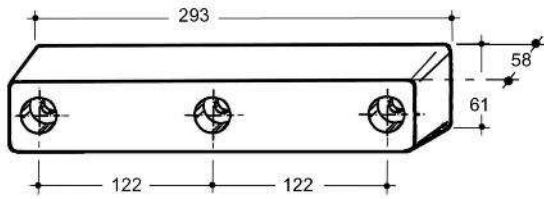

Art. 49-00048
 Tampone in gomma 293x61xH.58
 Rubber buffer 293x61xH.58

(Kg.1,338)

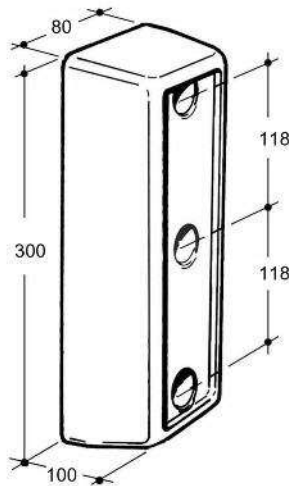

Art. 49-00049 (Kg.2,753)
 Tampone in gomma 300x80xH.100
 Rubber buffer 300x80xH.100

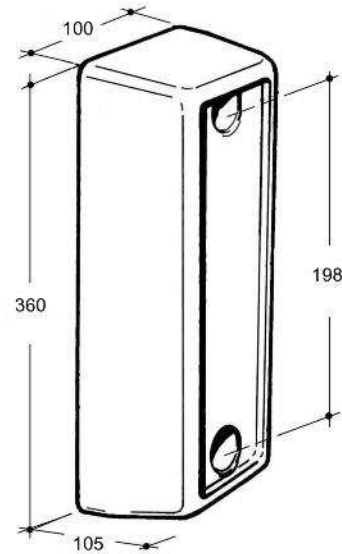

Art. 49-00061 (Kg.4,034)
 Tampone in gomma 360x100xH.105
 Rubber buffer 360x100xH.105

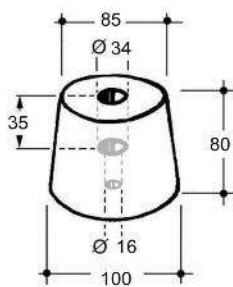

Art. 49-00050 (Kg.0,655)
 Tampone in gomma D.100xD.85xH.80
 Conical rubber buffer D.100xD.85xH.80

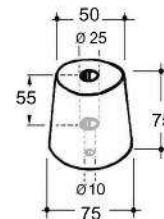

Art. 49-00062 (Kg.0,305)
 Tampone in gomma D.75xD.50xH.75
 Conical rubber buffer D.75xD.50xH.75

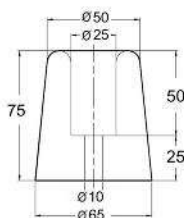

Art. 4900075 (Kg.0,305)
 Tampone in gomma D.65xD.50xH.75
 Conical rubber buffer D.65xD.50xH.75

Tamponi e Paracolpi

Rubber buffers

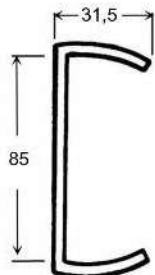

Art. 49-00058 (Kg.6,000)
 Supporto zinc. L=2600 per tamponi
 49-00053 e 49-00055
 Galv.steel fixing profile L=2600
 for bumper 49-00053 and 49-00055

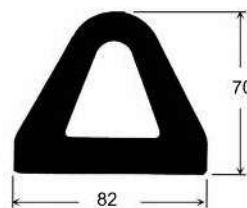

Art. 49-00053 (Kg.10,000)
 Tampone in gomma L=2600 - H.70 - L.82
 Black rubber bumper profile L=2600 - H.70 - L.82

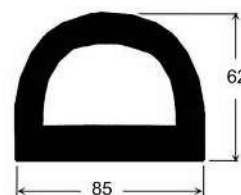

Art. 49-00055 (Kg.9,540)
 Tampone in PVC L=2600 - H.62 - L.85
 PVC bumper profile L=2600 - H.62 - L.85

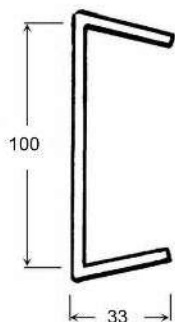

Art. 49-00057 (Kg.6,460)
 Supporto zinc.L=2600 per tamponi
 49-00054 e 49-00056
 Galv.steel fixing profile L=2600
 for bumper 49-00054 and 49-00056

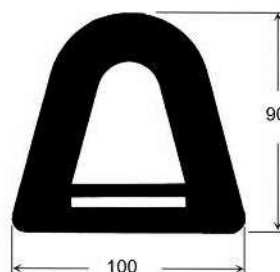

Art. 49-00054 (Kg.15,000)
 Tampone in gomma L=2600 - H.90 - L.100
 Black rubber bumper profile L=2600 - H.90 - L.100

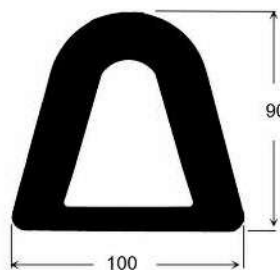

Art. 49-00056 (Kg.13,560)
 Tampone in PVC L=2600 - H.90 - L.100
 PVC bumper profile L=2600 - H.90 - L.100

Tamponi e Paracolpi

Rubber buffers

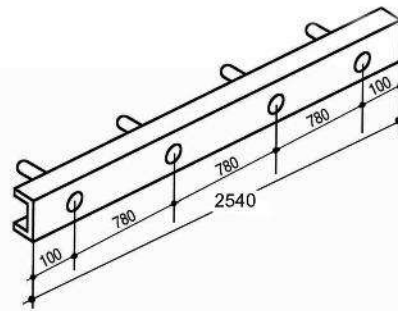
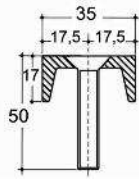
**Art. 49-00068**

(Kg.5,502)

Supporto zincato L=2540 per fissaggio tamponi 49-00070-71

Galvanized steel fixing profile L=2600 for bumper 49-00070 and 49-00071

Art. 49-00070

(Kg.12,350)

Tampone in gomma posteriore L=2600 - H.97 - L.88

Black rubber rear bumper profile L=2600 - H.97 - L.88

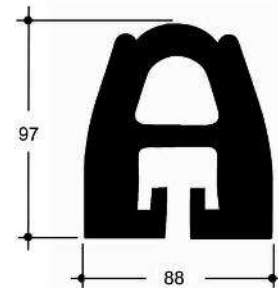
**Art. 49-00071**

(Kg.10,635)

Tampone PVC/GOMMA posteriore L=2600 - H.60 - L.70

Black rubber/PVC rear bumper profile L=2600 - H.60 - L.70

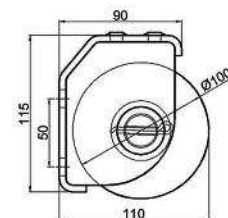
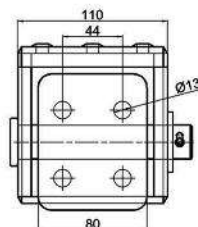
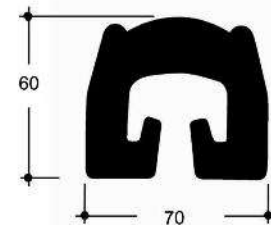
**Art. 49-00180**

(Kg.2,750)

Paracolpi posteriore orizzontale con struttura zincata (1 rullo)

Horizontal roller buffers zinc plated housing (1 roller)

Tamponi e Paracolpi

Rubber buffers

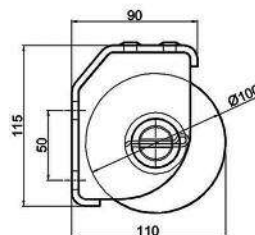
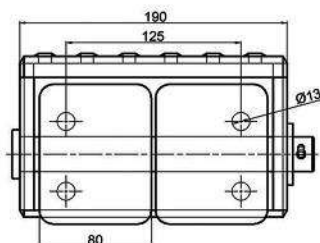

Art. 49-00182

(Kg.5,500)

Paracolpi posteriore orizzontale con struttura zincata (2 rulli)

Horizontal roller buffers zinc plated housing (2 roller)

Art. 49-00185

(Kg.0,880)

Rullo per paracolpi 49-00180 e 49-00182

Roller for buffers 49-00180 and 49-00182

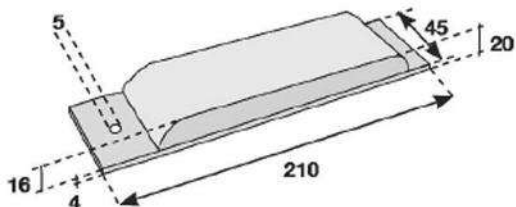
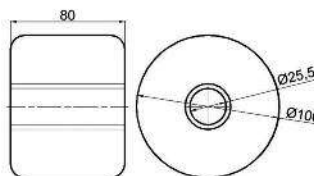

Art. 49-00080

(Kg.0,430)

Batticolpo per ribaltabile 210 x 45 x Sp. 4 lam.+16 gomma

Rubber support for tilting body 210 x 45 x Tc. 4 + 16 rubber

Sp.lamiera = 4
Tc. plate = 4

Sp.gomma = 16
Tc.rubber = 16

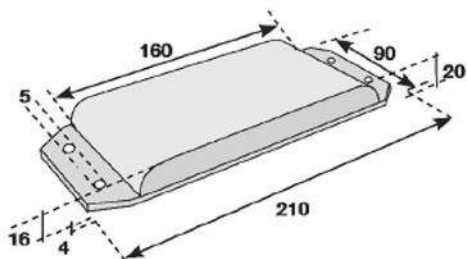

Art. 49-00081

(Kg.0,920)

Batticolpo per ribaltabile 210 x 90 x Sp. 4 lam.+16 gomma

Rubber support for tilting body 210 x 90 x Tc. 4 + 16 rubber

Sp.lamiera = 4
Tc. plate = 4

Sp.gomma = 16
Tc.rubber = 16

Supporti per tubo D.35 e D.50

Supports for tube D.35 and D.50

ART	Dimensioni / Dimensions					Lungh. Length	KG.
	A	B	C	D	E		
49-00065	102	93	46	8	35	50	0,295
49-00066	127	109	57	8	50	50	0,444
49-00067	102	93	46	8	35	50	0,173

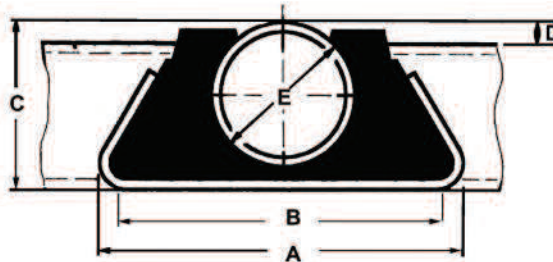

Art. 49-00065
Supporto completo D.35
(gomma + ferro)
Support complete D.35
(rubber + steel)



Art. 49-00065F
Supp. ferro per tubo D.35
Steel supp. for tube D.35
(Kg.0,181)

Art.49-00065G
Supp. gomma per tubo D.35
Rubber supp. for tube D.35
(Kg.0,114)

Art. 49-00066
Supporto completo D.50
(gomma + ferro)
Support complete D.50
(rubber + steel)



Art. 49-00066F
Supp. ferro per tubo D.50
Steel supp. for tube D.50
(Kg.0,243)

Art.49-00066G
Supp. gomma per tubo D.50
Rubber supp. for tube D.50
(Kg.0,201)

Art. 49-00067
Supporto completo D.35
(gomma + alluminio)
Support complete D.35
(rubber + aluminium)



Art. 49-00067A
Supp. alluminio per tubo D.35
Aluminium supp. for tube D.35
(Kg.0,059)

Art.49-00067G
Supp. gomma per tubo D.35
Rubber supp. for tube D.35
(Kg.0,114)

