

**Kit porte  
RE-ALL**

***RE-ALL  
doors kit***

**25**

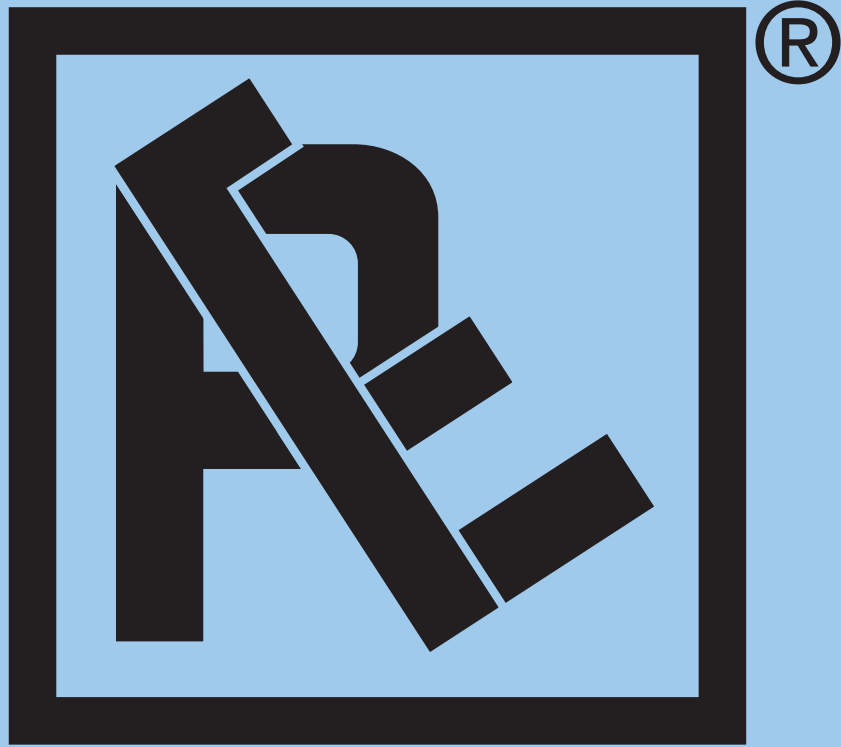

**RE - ALL**

## Kit porte per grandi volumi

## Doors kit for high volumes

Art.	Kit	Segmenti / segments	H.
25-00001	con prof.verticale / with vertical prof.	3	2.099
25-00002	con prof.verticale / with vertical prof.	3	2.350
25-00003	con prof.verticale / with vertical prof.	4	2.699
25-00004	con prof.verticale / with vertical prof.	4	2.800
25-00005	con prof.verticale / with vertical prof.	5	3.135
25-00007	con prof.verticale / with vertical prof.	5	3.299
25-00009	con prof.verticale / with vertical prof.	3	2.500

( VEDI RETRO LEGENDA / SEE THE BACK LEGEND ) →

RE-ALL DOORS KIT

Kit porte per grandi volumiDoors kit for high volumes

Rif./ Ref.	Descrizione	Description
A	Profilo superiore orizzontale sx	Upper left horizontal profile
B	Profilo superiore orizzontale dx	Upper right horizontal profile
C	Profilo inferiore orizzontale sx	Lower horizontal left profile
D	Profilo inferiore orizzontale dx	Lower right horizontal profile
E	Profilo verticale centrale su battente sx	Vertical central profile on left shutter
F	Profilo verticale centrale su battente dx	Vertical central profile on right shutter
G	Profilo verticale con segmenti	Vertical profile with segments
H	Cardine - boccola - perno	Hinge pin and bushing
I	Guida esterna zincata superiore	External galvanized upper guide
L	Guida esterna zincata inferiore	External galvanized lower guide
M	Guida interna zincata inferiore/superiore	Help internal galvanized upper / lower
N	Squadretta	Bracket
O	Guarnizione perimetrale	Perimeter seal
P	Guarnizione battente interno sx	Left inside shutter seal
Q	Tappo guida cerniera	Cap hinge guide
R	Scontro	Comparison
S	Chiusura boxer	Boxer closure

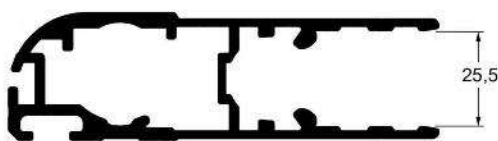
Ricambi per Kit porte grandi volumiParts Kit for doors high volumes

PROFILI ORIZZONTALI / HORIZONTAL PROFILES					
Rif./Ref.	Art.	tipo / type	L.		Kg.
B	25-00020	Superiore Upper	1246	dx right	2,321
A	25-00021	Superiore Upper	1246	sx left	2,321
D	25-00030	Inferiore Lower	1246	dx right	2,321
C	25-00031	Inferiore Lower	1246	sx left	2,321

## Ricambi per Kit porte grandi volumi

## Parts Kit for doors high volumes

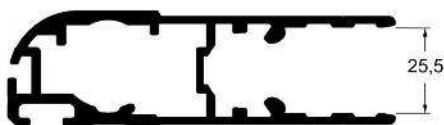

PROFILI VERTICALI CENTRALI / VERTICAL CENTRAL PROFILES					
Rif. / Ref.	Art.	tipo / type		L.	Kg
E	25-00040	Centrale su battente Central on shutter	SX left	2099	3,990
E	25-00041	Centrale su battente Central on shutter	SX left	2350	4,470
E	25-00042	Centrale su battente Central on shutter	SX left	2500	4,799
E	25-00044	Centrale su battente Central on shutter	SX left	2699	5,142
E	25-00045	Centrale su battente Central on shutter	SX left	2800	5,335
E	25-00046	Centrale su battente Central on shutter	SX left	3135	5,935
E	25-00048	Centrale su battente Central on shutter	SX left	3235	6,608

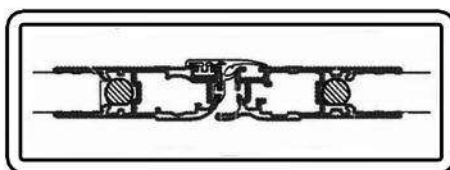

PROFILI VERTICALI CENTRALI / VERTICAL CENTRAL PROFILES					
Rif. / Ref.	Art.	tipo / type		L.	Kg
F	25-00050	Centrale su battente Central on shutter	dx right	2099	4,202
F	25-00051	Centrale su battente Central on shutter	dx right	2350	4,700
F	25-00052	Centrale su battente Central on shutter	dx right	2500	5,050
F	25-00054	Centrale su battente Central on shutter	dx right	2699	5,423
F	25-00055	Centrale su battente Central on shutter	dx right	2800	5,630
F	25-00056	Centrale su battente Central on shutter	dx right	3135	6,378
F	25-00058	Centrale su battente Central on shutter	dx right	3235	6,741

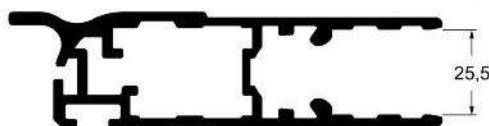

## Ricambi per Kit porte grandi volumi

## Parts Kit for doors high volumes

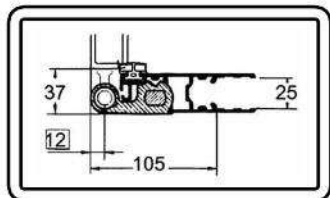

## PROFILI VERTICALI CON SEGMENTI / PROFILES VERTICAL WITH SEGMENTS

Rif. Ref.	Art.	Nr. segmenti Nr. segments	H.	interasse wheelbase	Kg
G/1	25-00060	3	2099	600	5,638
G/0	25-00061	3	2350	850	6,360
G/2	25-00068	3	2500	850	6,759
G/3	25-00062	4	2699	600	7,265
G/4	25-00067	4	2800	700	7,520
G/5	25-00064	5	3135	600	8,678
G/6	25-00066	5	3299	600	9,038

(G1)

(G0)

(G2)

(G3)

(G4)

(G5)

(G6)

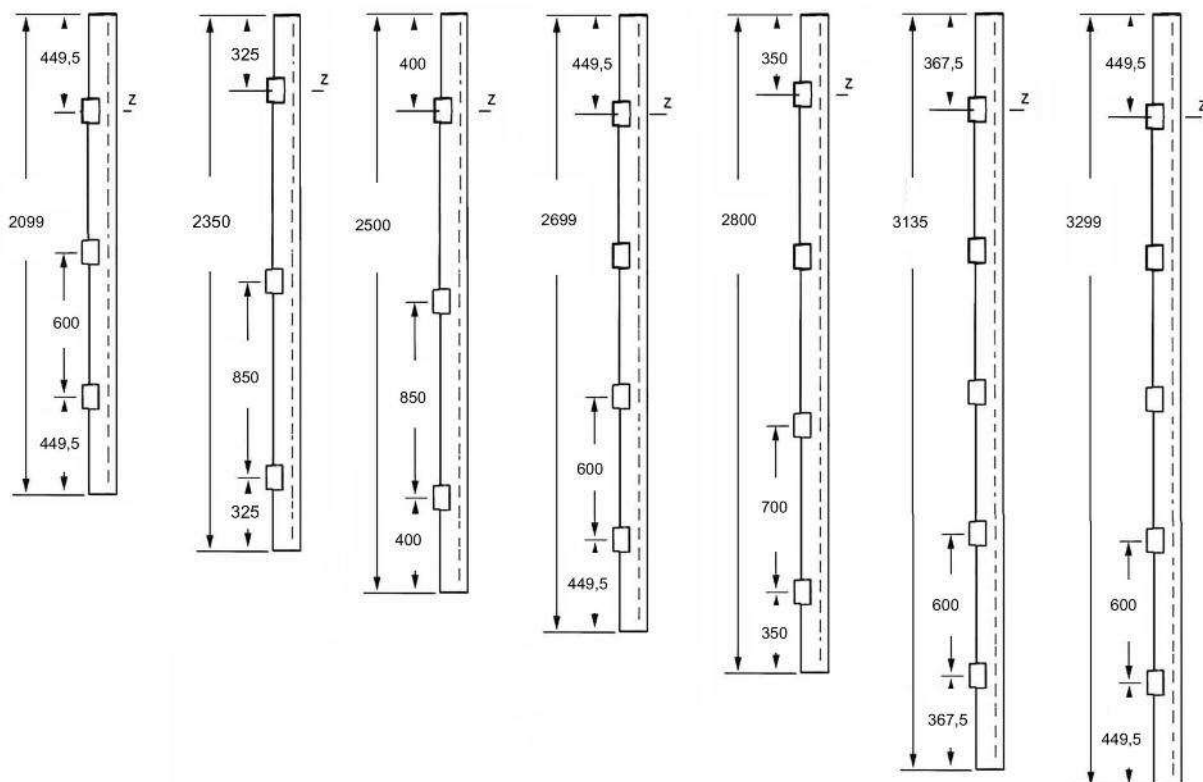



Ricambi per Kit porte grandi volumi

Parts Kit for doors high volumes

Cerniere centrali per porte posteriori

Central hinges for rear doors

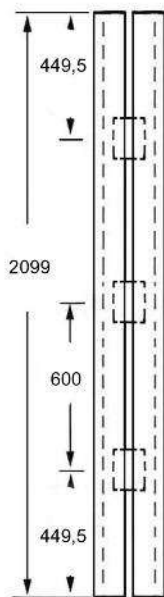
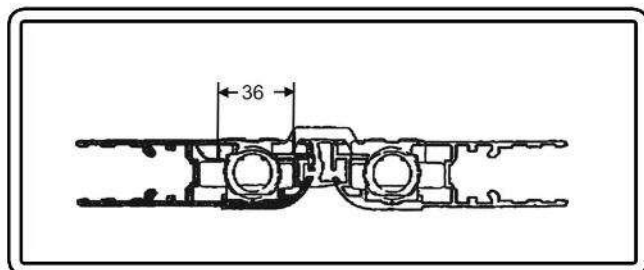

**Art. 25-00070**  
Cerniera centrale per  
porte posteriori con :  
3 segmenti  
H=2099  
interasse da 600

*Central hinge for  
rear doors with  
3 segments  
H=2099  
wheelbase 600*

(Kg. 11,000)

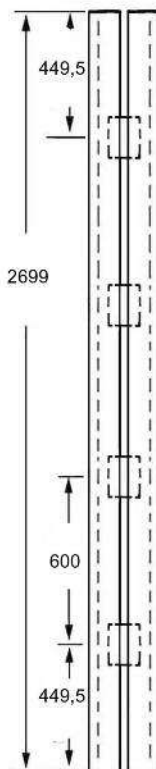

**Art. 25-00072**  
Cerniera centrale per  
porte posteriori con :  
4 segmenti  
H=2699  
interasse da 600

*Central hinge for  
rear doors with :  
4 segments  
H=2699  
wheelbase 600*

(Kg. 14,500)

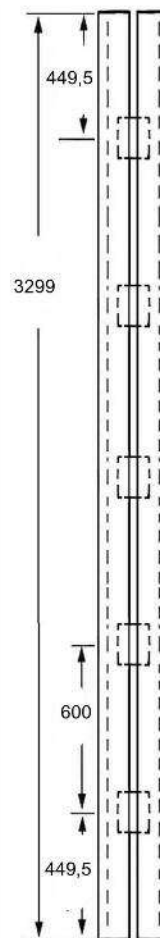

**Art. 25-00074**  
Cerniera centrale per  
porte posteriori con  
5 segmenti  
H=3299  
interasse da 600

*Central hinge for  
rear doors with  
5 segments  
H=3299  
wheelbase 600*

(Kg. 18,000)

## Ricambi per Kit porte grandi volumi

## Parts Kit for doors high volumes

Kit cerniera / Kit hinge				
Rif. Ref.	Art.	tipo / type		Kg.
H	25-00100/C	Kit cardine-boccola-perno Kit hinge-bushing-pin		
H	25-00105/C	Kit cardine-boccola-perno Kit hinge-bushing-pin	inox S.S.	
componenti kit / components kit				
Rif. Ref.	Art.	tipo / type		Kg.
1	25-00101	Cardine a saldare Hinge to weld		0,083
1	25-00105	Cardine a saldare Hinge to weld	inox S.S.	
2	25-00103	Perno D.12 x L180 Pin D.12 x L180	inox	0,159
3	25-00102	Boccola Bushing		0,005

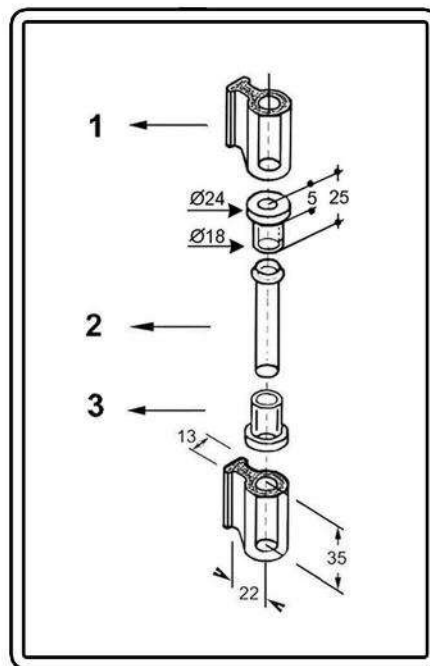

## Guide Asta

## Guides Pole

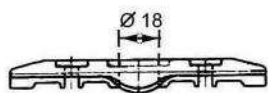

I

**Art. 25-00110**  
Guida esterna superiore zinc.  
External galv. upper guide

(Kg. 1,122)

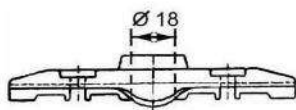

L

**Art. 25-00111**  
Guida esterna inferiore zinc.  
External galv. lower guide

(Kg.0,149)

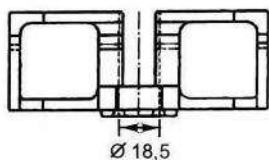

M

**Art. 25-00112**  
Guida interna inferiore/superiore zinc.  
Internal galv. upper and lower guide

(Kg. 0,202)

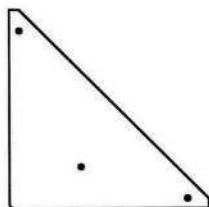

N

**Art. 25-00114**  
Squadretta / Bracket

(Kg 0,171)



## Ricambi per Kit porte grandi volumi

## Parts Kit for doors high volumes

**Guarnizioni**

/

**Seals**



O

**Art. 25-00130**  
Guarnizione perimetrale  
*Perimetric seal*

(Kg/ml.0,216)



**Art. 25-00131**  
Guarnizione per cerniere a doppia articolazione  
*Seal for double articulation hinge*

(Kg/ml.0,156)

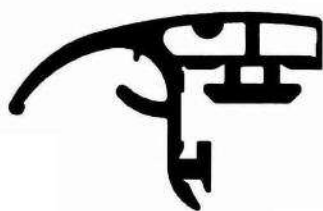

P

**Art. 25-00135**  
Guarnizione battente interno sx L=3330  
*Left inside shutter seal L=3330*

(Kg/ml.0,480)



Q

**Art. 25-00136**  
Tappo guida cerniera a doppia articolazione  
*Driving cap for hinge with double articulation*

(Kg/ml. 0,004)



**Art. 25-00090**  
Kit cardini da avvitare zincati per porte  
*Galvanized hinge to screw kit*

**Art. 25-00090/I**  
Kit cardini da avvitare INOX per porte  
*S.S. hinge to screw kit*

Ricambi per Kit porte grandi volumiParts Kit for doors high volumes**Chiusure BOXER D. 18**

/

**BOXER closure D. 18**

Art. 25-00138

Chiusura boxer completa zinc. con tondino D.18 / Complete boxer closure galv. with rod D.18

Art. 25-00139

Chiusura boxer completa zinc. senza tondino D.18 / Complete boxer closure galv. without rod D.18

Art. 25-00148

Chiusura boxer completa inox con tondino D.18 / Complete boxer closure S.steel with rod D.18

Art. 25-00149

Chiusura boxer completa inox senza tondino D.18 / Complete boxer closure S.s. without rod D.18

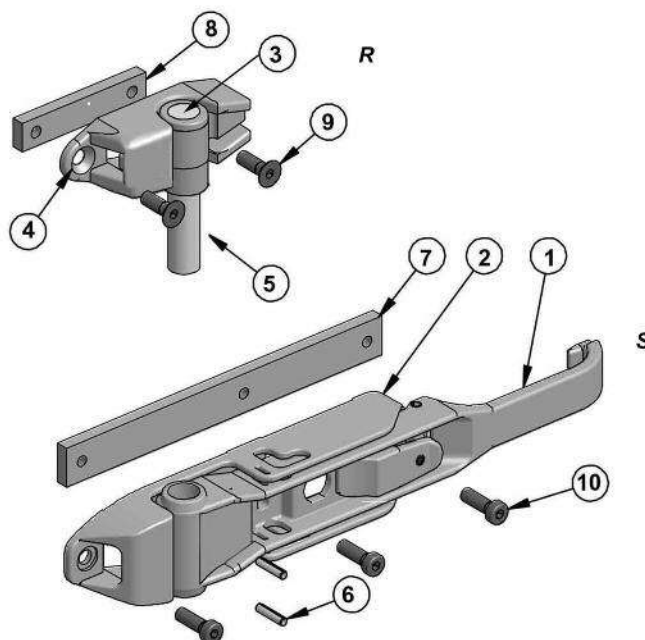

Rif.	Art.		descrizione componenti	description components
Ref.	zinc / galv.	inox/S.steel		
1	25-00140	25-00150	Maniglia boxer	boxer handle
2	25-00141	25-00151	Scontro inferiore per maniglia	lower handle positive stop
3	25-00142	25-00152	Arpione superiore	upper hook
4	25-00143	25-00153	Scontro per arpione superiore	positive stop for top hook
5	25-00144	25-00144	tondino zincato D.18	Galvanized rod D.18
6	31-00096	31-00096	Spine D. 5 x 30	Plug D.5 x 30
7	25-00146	25-00146	Piatto per ancoraggio scontro inferiore	Anchor plate for lower positive stop
8	25-00147	25-00147	Piatto per ancoraggio scontro superiore	Anchor plate for upper positive stop
9	31-00076	31-00076	Vite svasata 8 x 25	Countersunk screw 8x25
10	25-00159	25-00159	Vite a T bombata esagonale D. 8 x 25	T-rounded hexagonal screw D.8 x 25

## Componenti per chiusura boxer

Art. 25-00140/C		
Kit zinc. chiusura boxer composto : Kit galv. boxer closure composed :		
1	Art. 25-00140	Nr. 1
2	Art. 25-00141	Nr. 1
3	Art. 25-00142	Nr. 1
4	Art. 25-00143	Nr. 1

## Components for boxer closure

Art. 25-00150/C		
Kit zinc. chiusura boxer composto : Kit galv. boxer closure composed :		
1	Art. 25-00150	Nr. 1
2	Art. 25-00151	Nr. 1
3	Art. 25-00152	Nr. 1
4	Art. 25-00153	Nr. 1

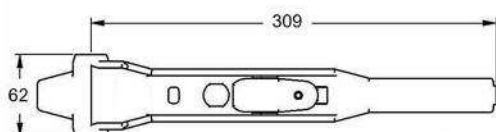

(1)

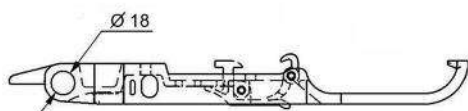

**Art. 25-00140**  
Maniglia boxer zincata  
Galvanized handle boxer  
(Kg 1,190)

**Art. 25-00150**  
Maniglia boxer inox  
S.steel handle boxer

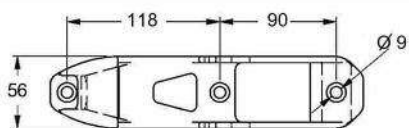

(2)

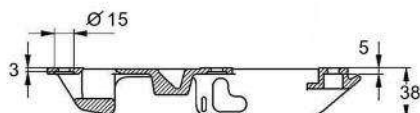

**Art. 25-00141**  
Scontro inferiore per maniglia zincata  
Lower positive stop galvanized handle  
(Kg,0,980)

**Art. 25-00151**  
Scontro inferiore per maniglia inox  
Lower positive stop s.steel handle

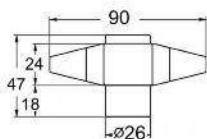

(3)

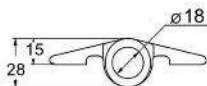

**Art. 25-00142**  
Arpione superiore zincato  
Upper galvanized hook  
(Kg,0,204)

**Art. 25-00152**  
Arpione superiore inox  
Upper stainless steel hook

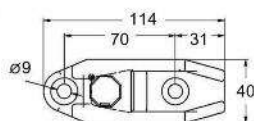

(4)

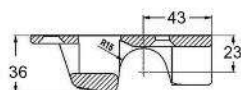

**Art. 25-00143**  
Scontro per Arpione superiore zincato  
Positive stop for upper galvanized hook  
(Kg,0,326)

**Art. 25-00153**  
Scontro per Arpione superiore inox  
Positive stop for upper s.steel hook

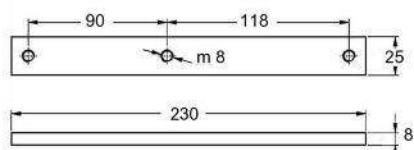
**Componenti per chiusura boxer**

(7)

**Components for boxer closure**

**Art. 25-00146** (Kg.0,350)  
 Piatto per ancoraggio scontro inferiore zinc.  
*Lower galv.plate for positive stop anchoring*

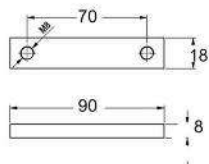

(8)

**Art. 25-00147** (Kg.0,095)  
 Piatto per ancoraggio scontro superiore zinc.  
*Upper galv.plate for positive stop anchoring*

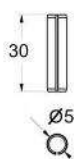

(6)

**Art. 31-00096** (Kg.0,002)  
 Spina elastica D.5x30  
*Elastic pin D.5x30*

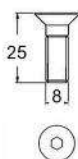

(9)

**Art. 31-00076** (Kg.0,002)  
 Vite svasata D.8x25  
*Countersunk screw D.8x25*

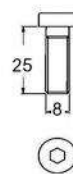

(10)

**Art. 25-00159** (Kg.0,012)  
 Vite a T bombata esagonale D. 8 x25  
*T-convex hexagonal screw D. 8 x 25*



(5)

**Art. 25-00144** (kg/ml 2,083)  
 Tondino zincato D.18 L=3500  
 (per art.25-00138 e 25-00148)  
 Galvanized rod D.18 L=3500  
 (for art. 25-00138 e 25-00148)

**Ricambi per la chiusura boxer / Spare parts for boxer closure**

**Art. 25-00162** (Kg.0,035)  
 Sicurezza chiusura boxer / Closure boxer safety pin

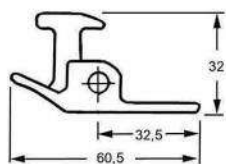

(kg 0,077)

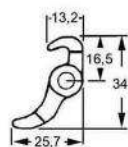
**Art. 25-00160**

(kg 0,020)

Pulsante chiusura boxer / *Boxer closure Button*

(kg 0,003)

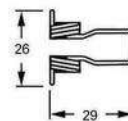

(kg 0,003)



**Kit chiusura thiriet**

**Kit thiriet closure**

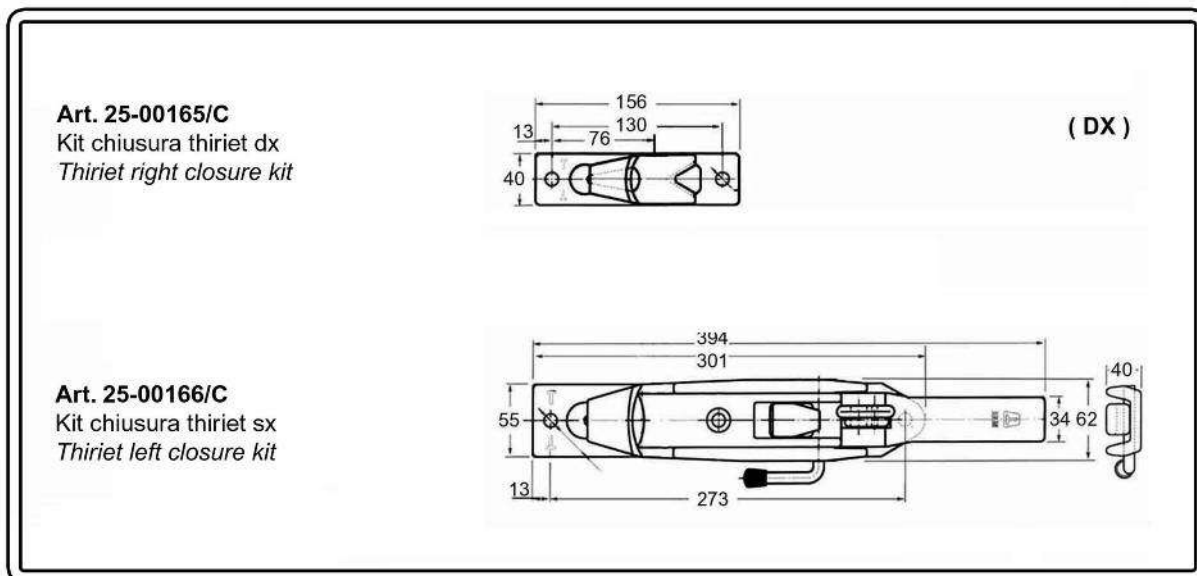

**Art. 25-00165/C**  
Kit chiusura thiriet dx  
Thiriet right closure kit

**Art. 25-00166/C**  
Kit chiusura thiriet sx  
Thiriet left closure kit



**Art. 25-00169** (Kg.0,468)  
Scontro superiore  
Upper positive stop



**Art. 25-00168** (Kg.0,290)  
Arpione / hook

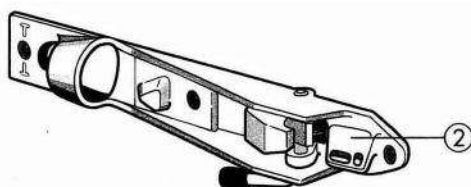

**Art. 25-00166** (Kg.1,584)  
Scontro inferiore destro  
Lower right positive stop

**Art. 25-00167** (Kg.1,584)  
Scontro inferiore sinistro  
Lower left positive stop

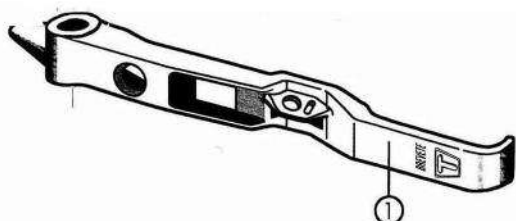

**Art. 25-00165** (Kg.1,108)  
Maniglia / Handle



## Cerniere in alluminio per profili verticali e componenti

### Aluminium hinge for vertical profiles and components

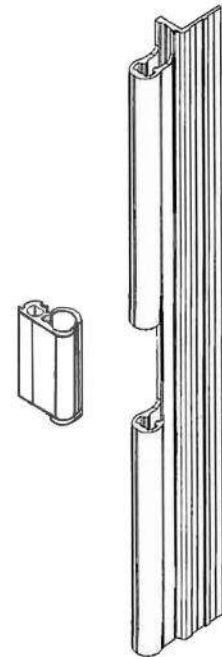
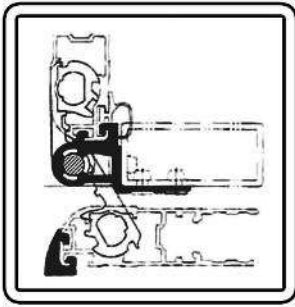

Cerniera in alluminio per profili verticali / Aluminium hinge for vertical profiles

Art.	L=	nr. Segmenti nr. Segments	H.	interasse wheelbase	Kg
25-00180	2055	3	2099	600	2,673
25-00181	2350	3	2306	600	2,936
25-00182	2456	3	2500	850	3,370
25-00184	2655	4	2699	600	3,483
25-00185	2756	4	2800	700	3,615
25-00186	3255	5	3135 / 3299	600	4,295

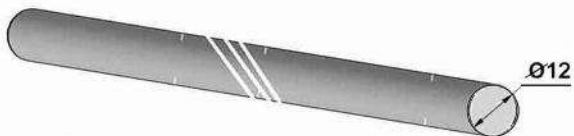

#### Art. 25-00190

Tondino in alluminio anodizzato D. 12 L=1500  
Anodized aluminium rod D.12 L=1500

(Kg/ml.0,307)

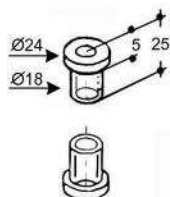

#### Art. 25-00102

Boccola / Bushings  
(Kg.0,005)

**Cerniere in alluminio per profili verticali e componenti**

***Aluminium hinge for vertical profiles and components***

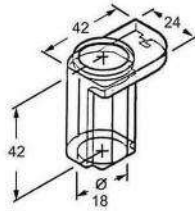

**Art. 25-00195**

Boccola per prof. Verticale a segmenti D. 18 sx  
Segments bushing for vertical profile D.18 left

(Kg.0,017)

**Art. 25-00196**

Boccola per prof. Verticale a segmenti D. 18 dx  
Segments bushing for vertical profile D.18 right

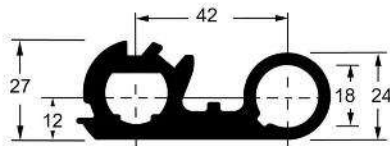

**Art. 25-00197**

Segmento per profilo a segmenti L=95  
Segment for segments profile L=95

(kg 0,194)

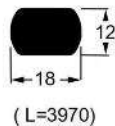

**Art. 25-00198**

Perno in alluminio per bloccaggio boccola/segmento  
Aluminium pin for bushing / segment locking

(kg 2,210)

**Profilo guida asta**

/

**Profile guide rod**



**Art. 25-00170**

Profilo guida asta per doppia chiusura e per porte con pannelli isolanti L=3300  
Guide rod profile for double closure and door with insulation panels L=3300

(Kg.2,342)

Kit per sportelli posteriori

/

Kit for rear doors

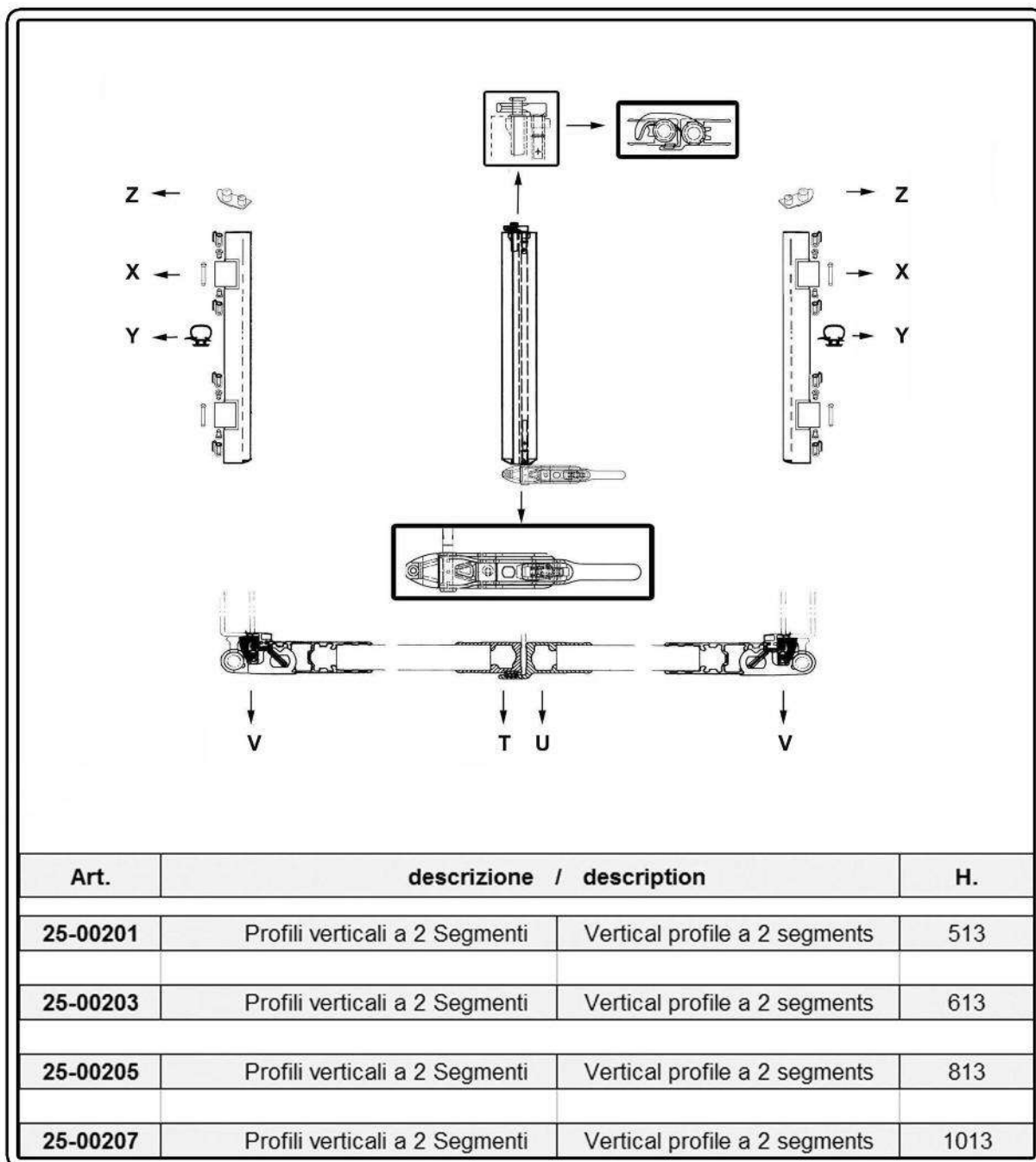

Rif./ Ref.	Descrizione / Description	Description
T	Profilo verticale centrale (battente sx con perno)	Vertical central profile (left shutter with pin)
U	Prof.verticale centrale (battente dx con chius.boxer)	Vertical central prof.(right shutter with boxer closure)
V	Profilo verticale con segmenti	Vertical profile with segments
Z	Tappo sx e dx	Left and right plug
X	Cardine - boccia - perno	Hinge - bushing - pin
Y	Guarnizione perimetrale	Perimetric seal

## Profili verticali per sportelli posteriori / Vertical profiles rear doors



PROFILI VERTICALI CENTRALI / VERTICAL CENTRAL PROFILES					
Rif. / Ref.	Art.	tipo / type		H	Kg
T	25-00220	battente con perno Shutter with pin	SX left	500	0,717
T	25-00222	battente con perno Shutter with pin	SX left	600	0,844
T	25-00224	battente con perno Shutter with pin	SX left	800	1,147
T	25-00226	battente con perno Shutter with pin	SX left	1000	1,384

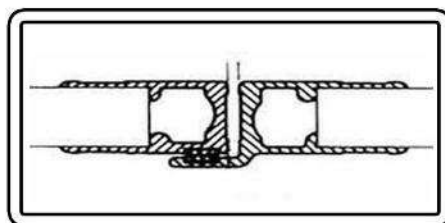

PROFILI VERTICALI CENTRALI / VERTICAL CENTRAL PROFILES					
Rif. / Ref.	Art.	tipo / type		H	Kg
U	25-00230	battente con chiusura Shutter with closure	dx right	500	0,840
U	25-00232	battente con chiusura Shutter with closure	dx right	600	1,010
U	25-00234	battente con chiusura Shutter with closure	dx right	800	1,350
U	25-00236	battente con chiusura Shutter with closure	dx right	1000	1,687

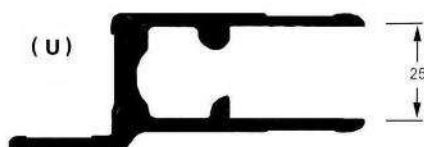

## Ricambi per Kit per sportelli posteriori

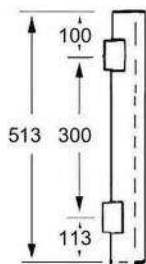
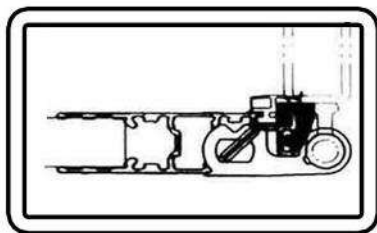
*Parts kit for doors high volumes*

(V1)

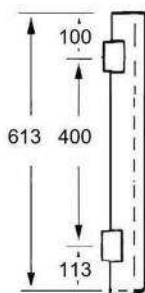

(V2)

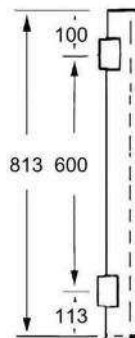

(V3)

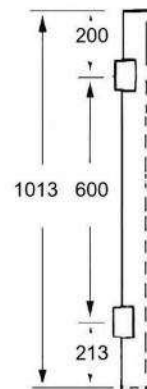

(V4)

## PROFILI VERTICALI CON SEGMENTI / PROFILES VERTICAL WITH SEGMENTS

Rif. Ref.	Art.	Nr. segmenti Nr. segments		H.	interasse wheelbase	Kg
V1	25-00240	2	DX	513	300	1,624
	SX		513			
V2	25-00244	2	DX	613	400	1,886
	SX		613			
V3	25-00248	2	DX	813	600	2,411
	SX		813			
V4	25-00252	2	DX	1013	600	2,834
	SX		1013			

(Z)

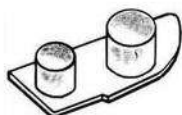
**Art. 25-00263**

Tappo dx per profili verticali sportelli posteriori  
Right plug for vertical profiles rear doors

(Kg.0,096)

**Art. 25-00264**

Tappo sx per profili verticali sportelli posteriori  
Left plug for vertical profiles rear doors

(Y)

**Art. 25-00130**

Guarnizione perimetrale  
Perimetric seal

(Kg/ml.0,216)



## Ricambi per Kit sportelli posteriori /

## Parts for Kit rear doors

Kit cerniera / Kit hinge			
Rif. Ref.	Art.	tipo / type	Kg.
X	25-00100/C	Kit cardine-boccola-perno <i>Kit hinge-bushing-pin</i>	
X	25-00105/C	Kit cardine-boccola-perno <i>Kit hinge-bushing-pin</i>	inox S.S.
Rif. Ref.	Art.	tipo / type	Kg.
1	25-00101	Cardine a saldare <i>Hinge to weld</i>	0,083
1	25-00105	Cardine a saldare <i>Hinge to weld</i>	inox S.S.
2	25-00103	Perno D.12 x L180 <i>Pin D.12 x L180</i>	inox 0,159
3	25-00102	Boccola <i>Bushing</i>	0,005

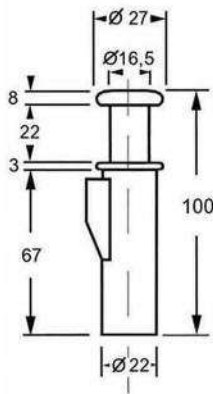
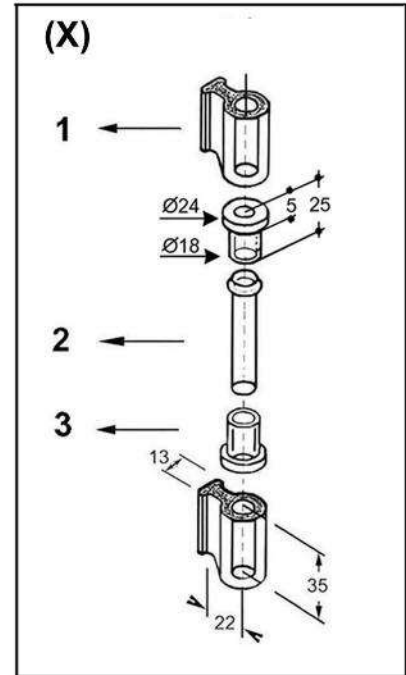

**Art. 25-00260**  
Perno bloccaggio sportelli  
Locking doors pin

(Kg.0,290)

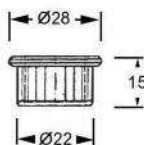

**Art. 25-00262**  
Boccola in ottone / Brass bush

(Kg.0,032)

