

Profili per furgoni

*Aluminium
sections for vans*

21

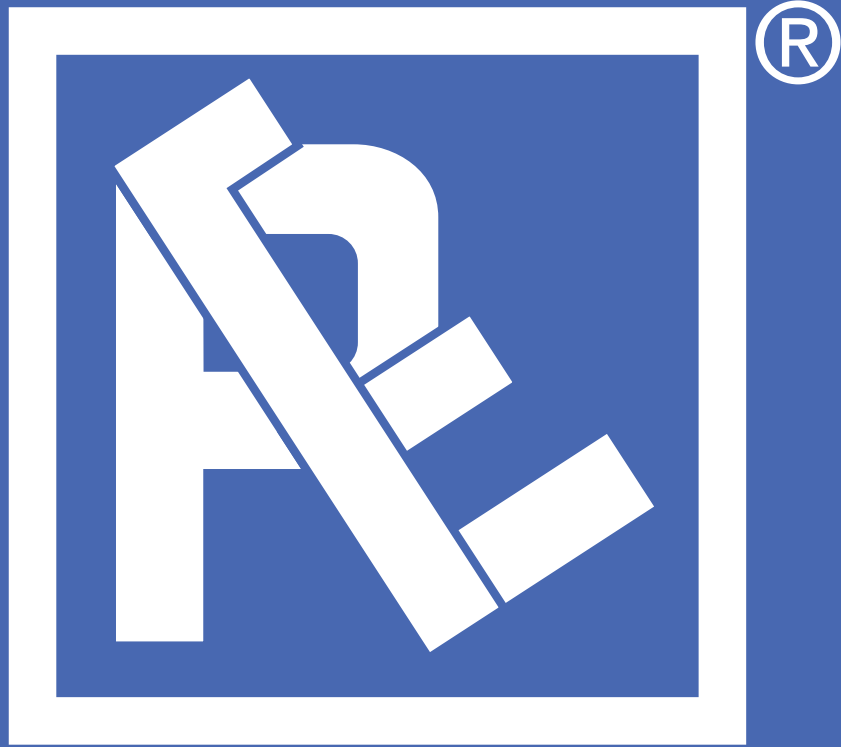

RE-ALL

Sezione di collegamento

/

Connection

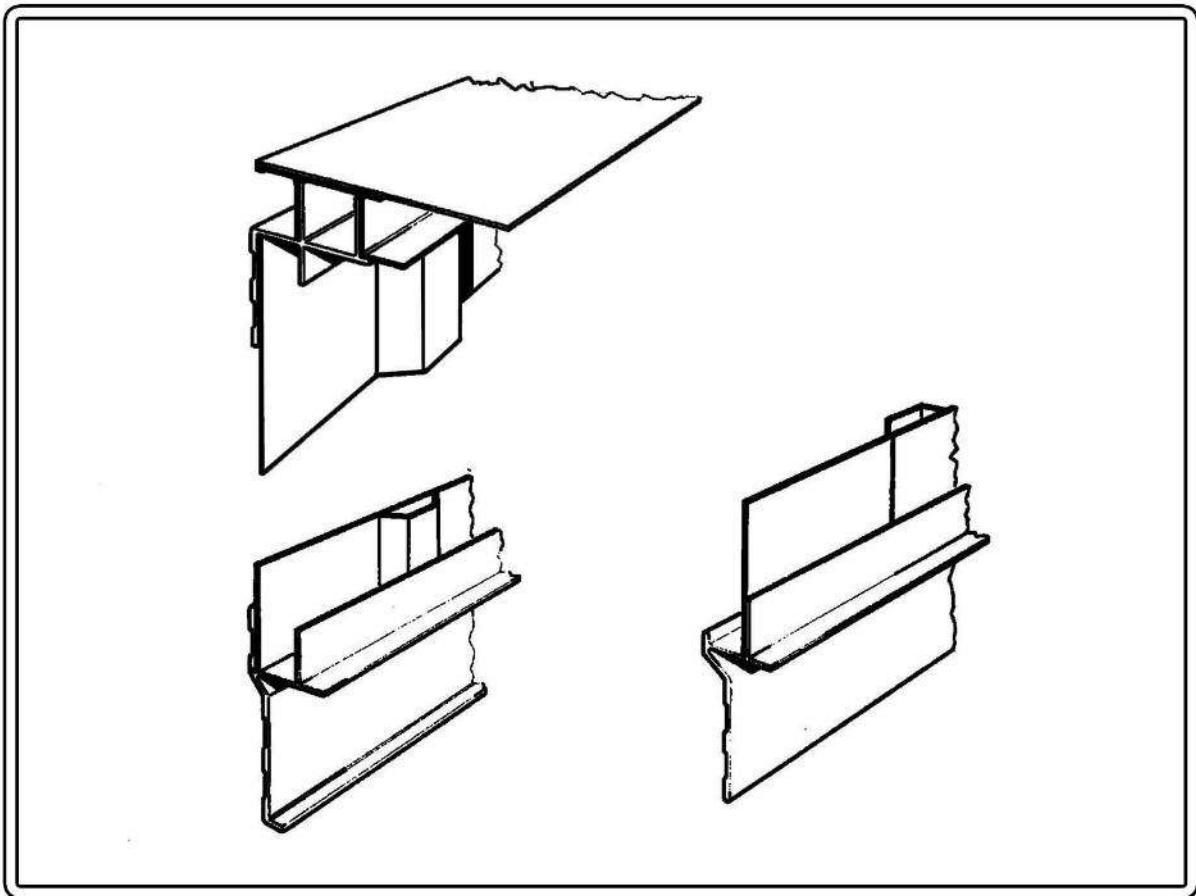

Liscio esterno / Smooth outer

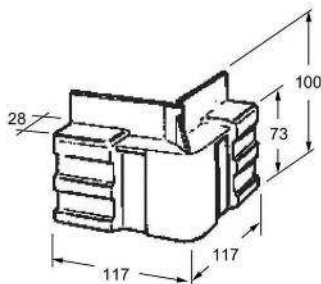

Art. 39-00126 (Kg.0,285)
 Cantonale superiore in all.per prof.21-00004
 Aluminium higher corner for profile 21-00004

Liscio interno / Smooth internal

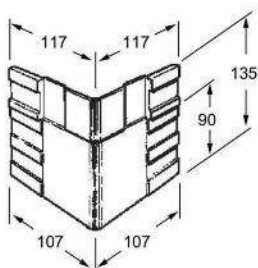

Art. 39-00127 (Kg.0,414)
 Cantonale inferiore in all.per profilo 21-00022
 Aluminium lower corner for profile 21-00022

PROFILI LEGA 6060-T6

ROOF STRUCTURE ALLOY 6060-T6

PROFILI TETTO

ROOF STRUCTURE

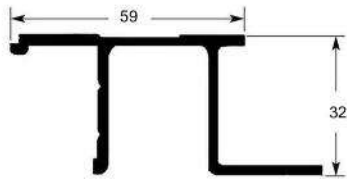

Art.	Lungh. Length	Kg/ml.
Contorno tetto	6000	
21-00002		0,967
Roof structure	7500	

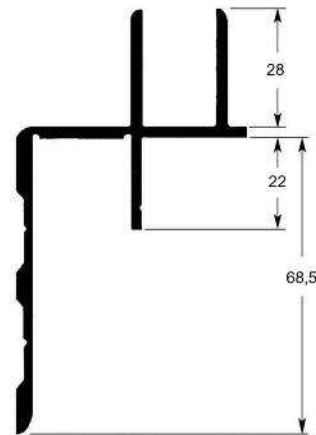

Art.	Lungh. Length	Kg/ml.
Superiore fiancata	6000	
21-00004		1,524
Roof structure	7500	

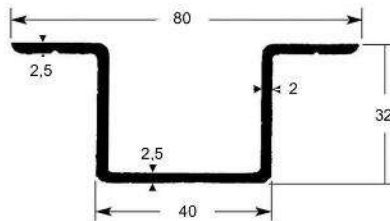

Art.	Lungh. Length	Kg/ml.
Centina per tetto		
21-00006		0,863
Roof structure	7500	

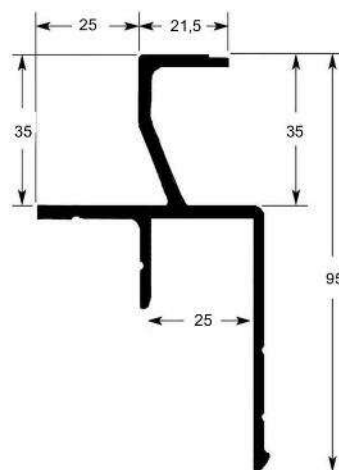

Art.	Lungh. Length	Kg/ml.
Contorno tetto e superiore fiancata		
21-00008		1,874
Roof structure	7500	

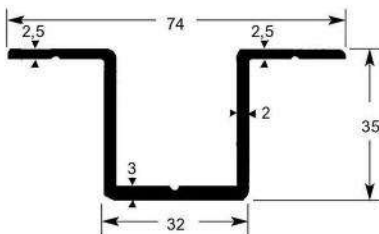

Art.	Lungh. Length	Kg/ml.
Centina per tetto		
21-00010		0,872
Roof structure	7500	

PROFILI LEGA 6060-T6 **ROOF STRUCTURE ALLOY 6060-T6**

CANTONALI **CORNER**

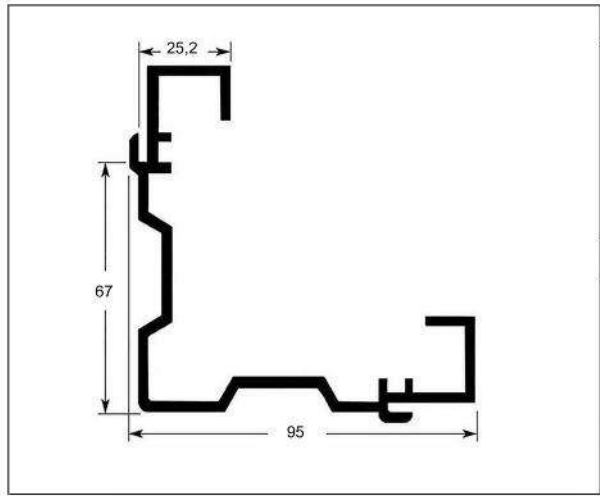

Art.	Lungh. Length	Kg/ml.
Cantonale leggero	6000	
	21-00019	2,106
Light corner	7500	

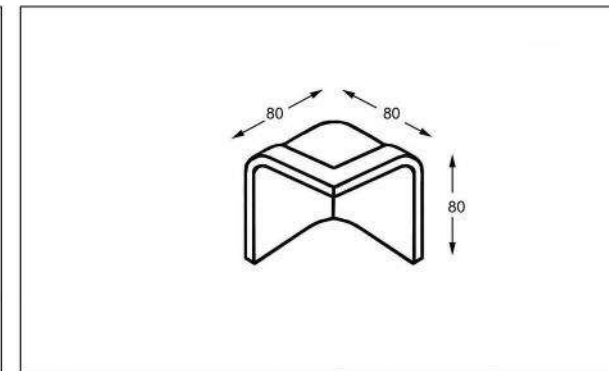
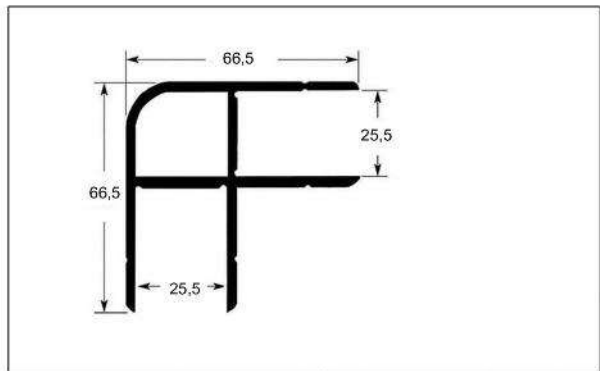

Art.	Lungh. Length	Kg/ml.
Cantonale 66,5 x 66,5	6000	
21-00020		1,958
Corner 66,5 x 66,5	7500	

Art.		Kg.
Cantonale superiore per furgoni per prof. 21-00020		
39-00129		0,186
Superior corner for profile 21-00020		

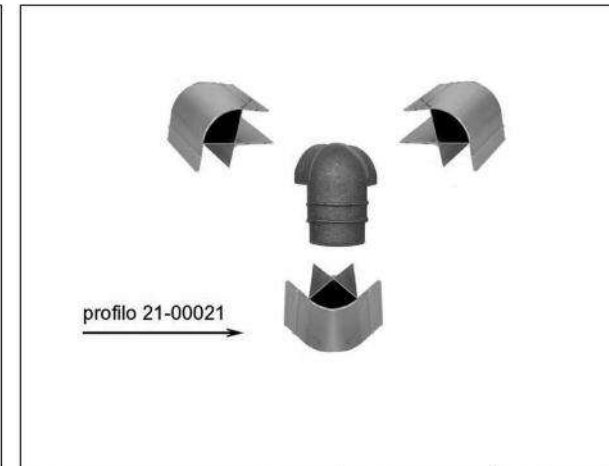
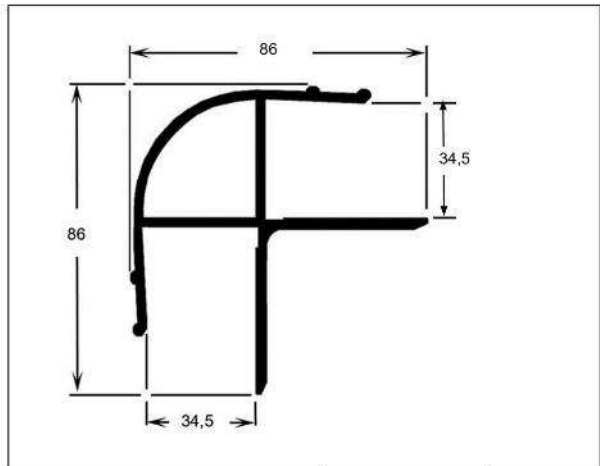

Art.	Lungh. Length	Kg/ml.
Cantonale 86x86		
21-00021		1,404
Corner 86x86	7500	

Art.		Kg.
Cantonale superiore per profilo 21-00021		
39-00125		0,330
Superior corner for profile 21-00021		

ALUMINIUM SECTIONS FOR VANS

PROFILI LEGA 6060 - T6

ROOF STRUCTURE ALLOY 6060 - T6

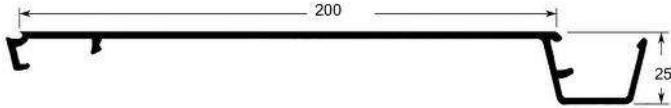
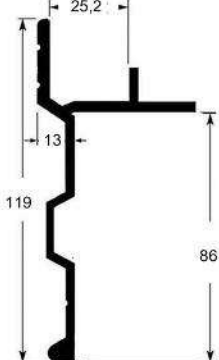
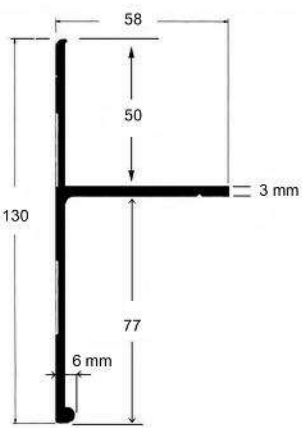
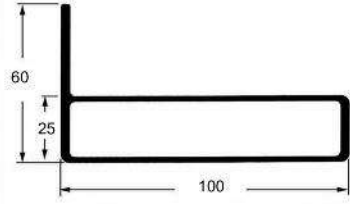
SNAP		Art.	Lungh. Length	Kg/ml.
	Profilo "SNAP" per fiancata furgoni			
	21-00014	7500	1,490	
	<i>Profile "SNAP" for the side of the van</i>			
	Longherina per "SNAP"			
	21-00023	7500	1,577	
	<i>Profile for "SNAP"</i>			
Profili per furgoni	Profiles for van	Art.	Lungh. Length	Kg/ml.
	Longherina per furgone in plastica			
	21-00025	7500	1,390	
	<i>Profile for van plastic</i>			
	Reggi mensola			
	21-00027	7500	1,180	
	<i>Profile for shelf</i>			

PROFILI LEGA 6060 - T6

ROOF STRUCTURE ALLOY 6060 - T6

Art. 49-00031

Guarnizione per profilo 21-00028
Seal for profile 21-00028

(rotolo/roll 50 mt.) (Kg.mt.0,193)

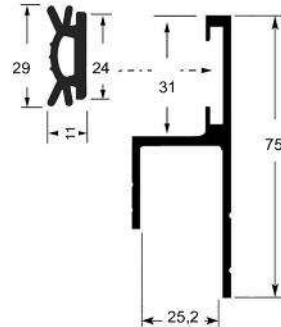
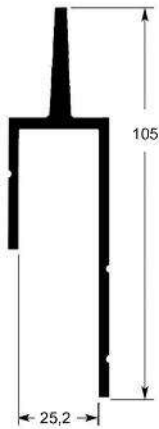

Art.	Lungh. Length	Kg/ml.	Art.	Lungh. Length	Kg/ml.
Profilo verticale battente sx	6000		Contorno porta	6000	
21-00026		1,168	21-00028		0,879
Profile for outline door (left side)	7500		Profile for outline door	7500	

Art. 49-00032

Guarnizione per profilo 21-00030
Seal for profile 21-00030

(rotolo/roll 50 mt.) (Kg.mt.0,089)

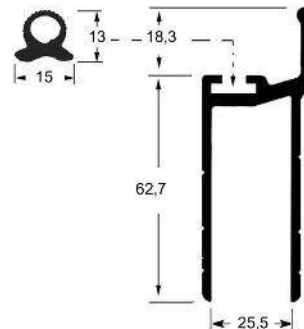
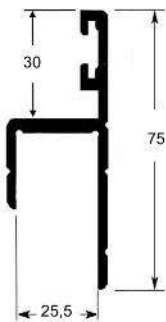

Art.	Lungh. Length	Kg/ml.	Art.	Lungh. Length	Kg/ml.
Contorno porta slim			Contorno porta		
21-00029	7500	1,107	21-00030	7500	1,242
Profile for outline slim-door			Profile for outline door		

PROFILI LEGA 6060 - T6

ROOF STRUCTURE ALLOY 6060 - T6

PROFILI TENDI TELONE

PROFILE FOR CURTAIN

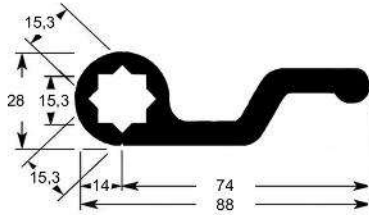
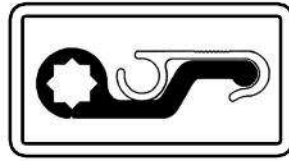

Art.	Lungh. Length	Kg/ml.	Art.	Lungh. Length	Kg/ml.
Leva tendi telone	5200		Profilo per tendi telone	5200	
21-00031		2,421	21-00033		0,953
Profile for curtain	6300		Profile for curtain	6300	

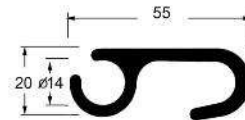
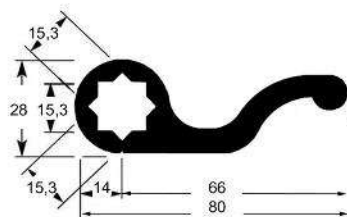

Art.	Lungh. Length	Kg/ml.	Art.	Lungh. Length	Kg/ml.
Leva tendi telone			Profilo per tendi telone		
21-00034	7500	2,200	21-00035	7500	1,007
Profile for curtain			Profile for curtain		

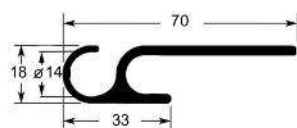

Art.	Lungh. Length	Kg/ml.
Profilo per tendi telone	5200	
21-00032		0,873
Profile for curtain	6300	

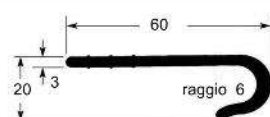

Art.	Lungh. Length	Kg/ml.
Profilo per tendi telone	5200	
21-00038		0,695
Profile for curtain	6300	

PROFILI LEGA 6060 - T6 **ROOF STRUCTURE ALLOY 6060 - T6**

PROFILI TENDI TELONE **PROFILE FOR CURTAIN**

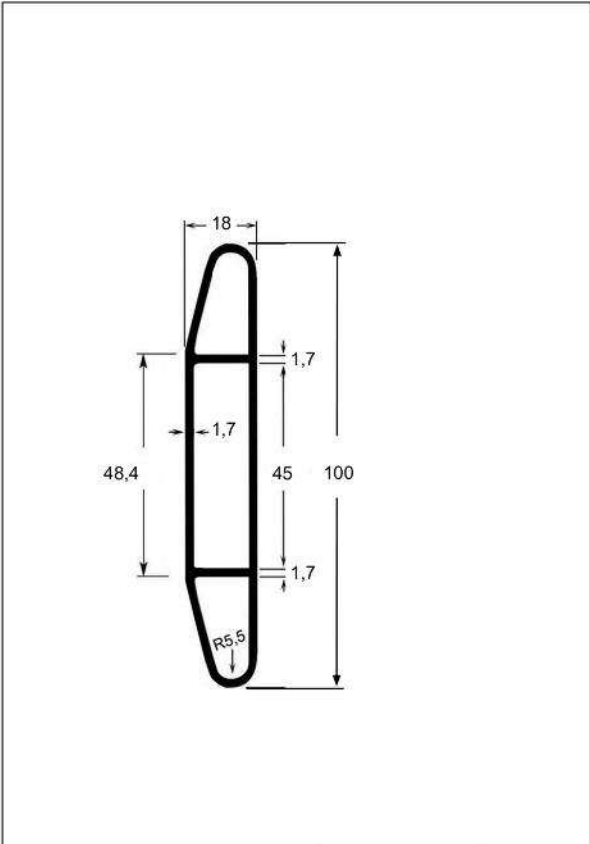

Art.	Lungh. Length	Kg/ml.
Profilo per teloni		
21-00048	6000	1,097
<i>Profile for curtain</i>		

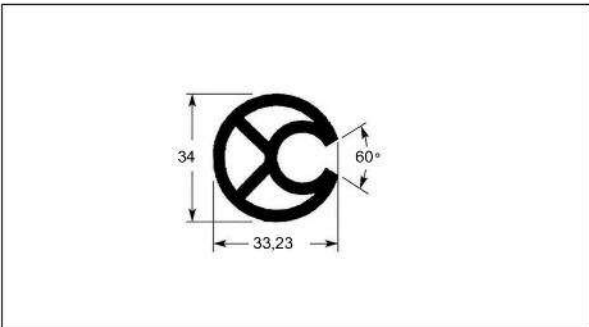

Art.	Lungh. Length	Kg/ml.
Avvolgitore tendi telone		
21-00045	6300	1,141
<i>Profile for curtain</i>		

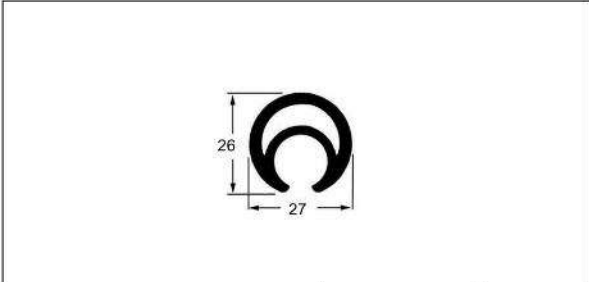

Art.	Lungh. Length	Kg/ml.
Avvolgitore tendi telone		
21-00047	6300	0,707
<i>Profile for curtain</i>		

PROFILO GUIDOVIA **GUIDEWAY PROFILE**

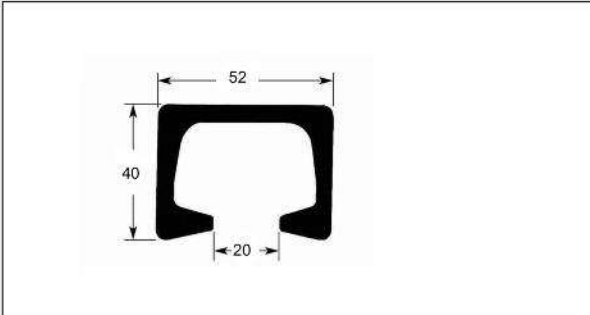

Art.	Lungh. Length	Kg/ml.
Guidovia a " C "		
21-00046	7500	2,136
<i>Guideway profile in aluminium to " C "</i>		

PROFILI LEGA 6060 - T6

ROOF STRUCTURE ALLOY 6060 - T6

ANGOLARI DI CONTORNO

CORNER

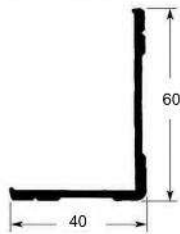

Art.	Lungh. Length	Kg/ml.
21-00039	7500	0,645

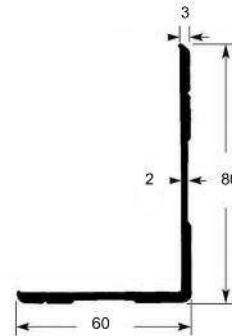

Art.	Lungh. Length	Kg/ml.
21-00040	7500	0,965

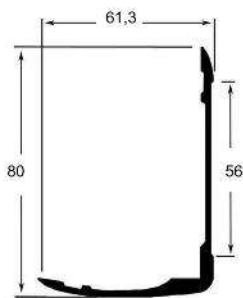

Art.	Lungh. Length	Kg/ml.
21-00050	7500	0,945

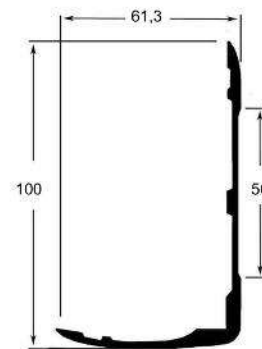

Art.	Lungh. Length	Kg/ml.
21-00051	7500	1,115

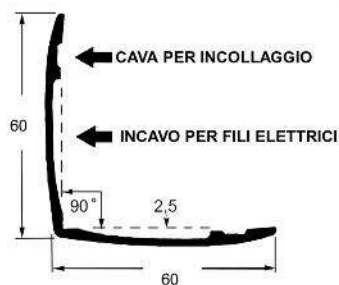

Art.	Lungh. Length	Kg/ml.
21-00043	7500	0,600

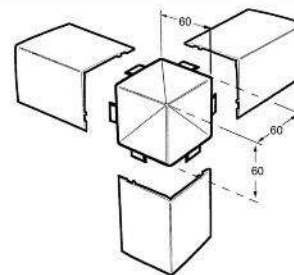

Art. 39-00128 (Kg,0,095)
 Cantonale superiore per furgoni isothermico
 per profilo 21-00043
 Higher corner for isothermic van for
 profile 21-00043

PROFILI LEGA 6060 - T6

ROOF STRUCTURE ALLOY 6060 - T6

CANTONALI

CORNER

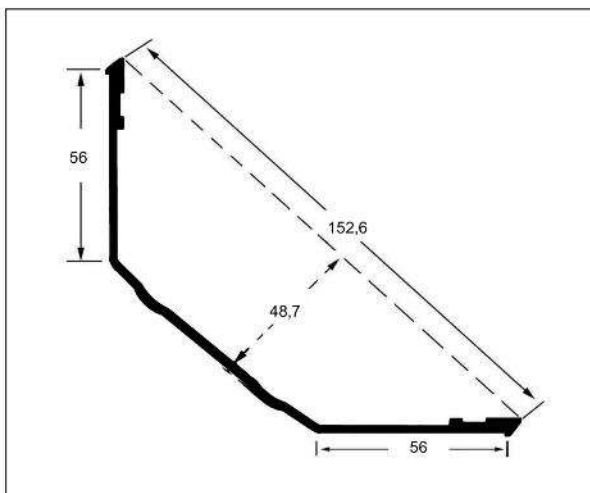

Art.	Lungh. Length	Kg/ml.
Cantonale		
21-00054	6000	1,058
Corner		

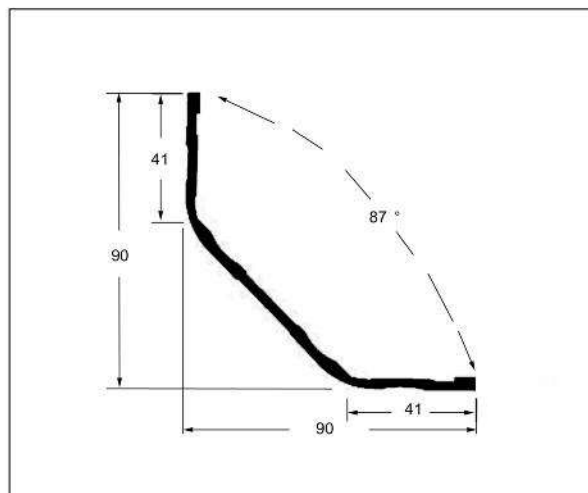

Art.	Lungh. Length	Kg/ml.
Cantonale		
21-00053	5700	0,906
Corner		

Cantonale in PVC

Pvc corner

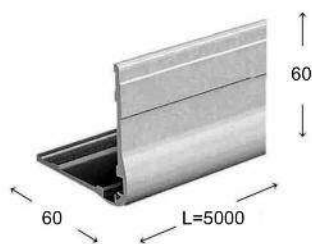

Art. 49-00110 (Kg.a barra 2,570)
Cantonale in pvc bianco L=5000
White pvc corner L=5000

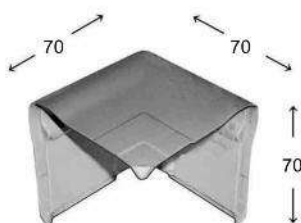

Art. 49-00112 (Kg.0,062)
Blocco d'angolo in pvc bianco per art. 49-00110
Higher white pvc corner for art.49-00110

PROFILI LEGA 6060 - T6

ROOF STRUCTURE ALLOY 6060 - T6

BATTISCOPA

BASEBOARD

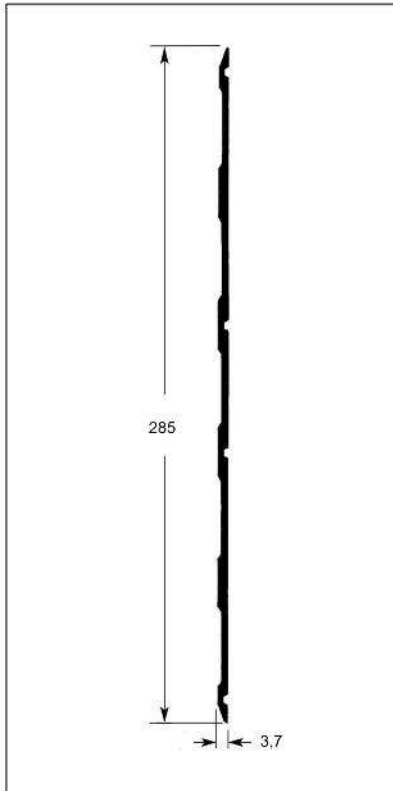

Art.	Lungh. Length	Kg/ml.
21-00042	7500	2,305

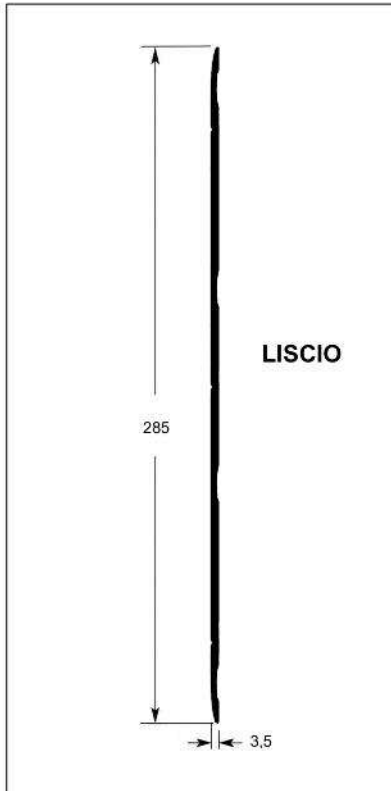

Art.	Lungh. Length	Kg/ml.
21-00070	7500	2,450

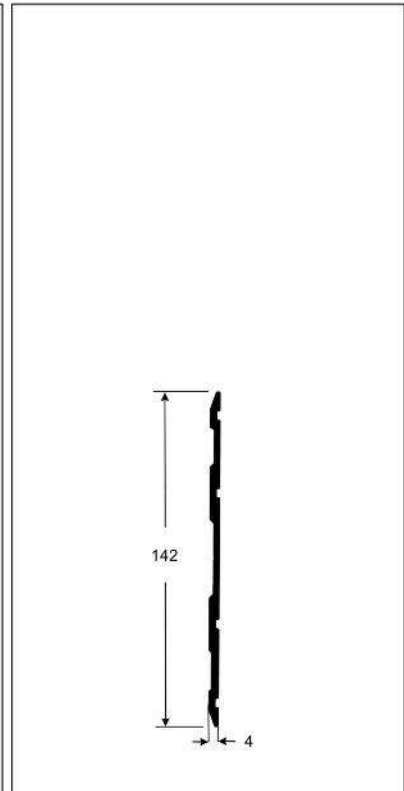

Art.	Lungh. Length	Kg/ml.
21-00055	7500	1,157

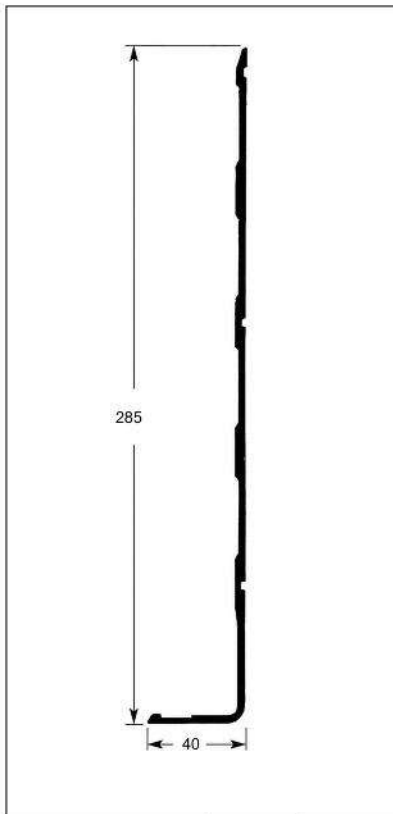

Art.	Lungh. Length	Kg/ml.
21-00044	7500	2,738

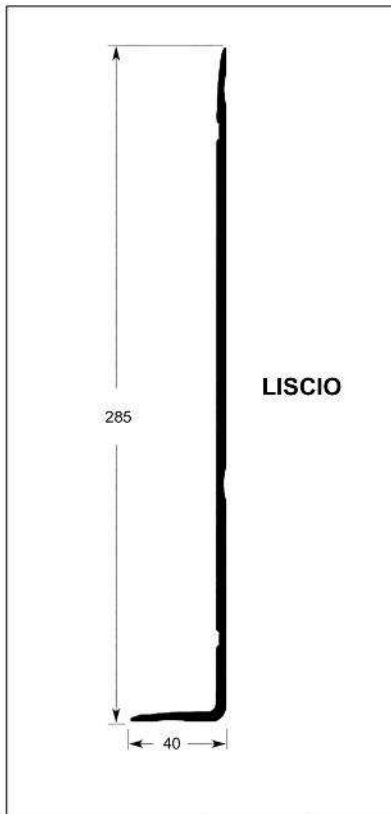

Art.	Lungh. Length	Kg/ml.
21-00072	7500	2,780

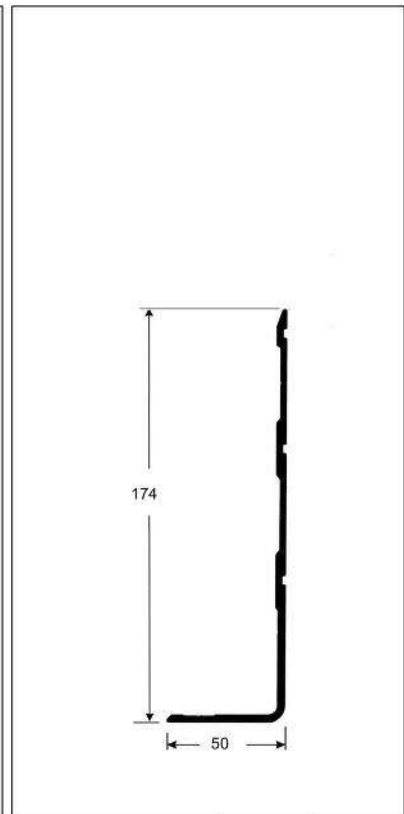

Art.	Lungh. Length	Kg/ml.
21-00056	7500	1,724

PROFILI LEGA 6005 - T6

ROOF STRUCTURE ALLOY 6005 - T6

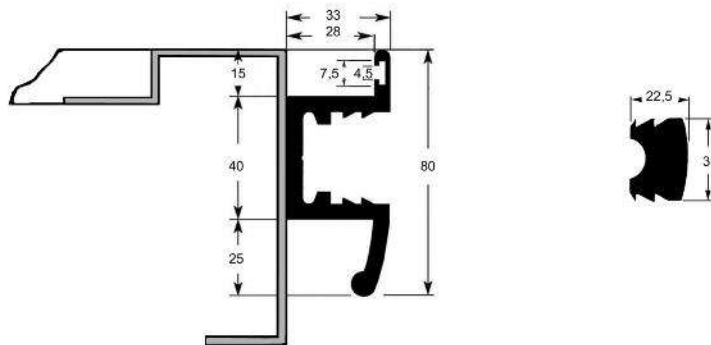

Art.	Lungh. Length	Kg/ml.	Art.		Kg/mt
Laterale per centina tipo Francia	6800		Guarnizione per profilo 21-00041	Rotolo 28 mt.	
21-00041		2,070	49-00043		0,810
Profile for curtain	7500		Seal for profile 21-00041	Roll 28 mt.	

TETTO FISSO "RE-ALL SRL "

ROOF "RE-ALL SRL "

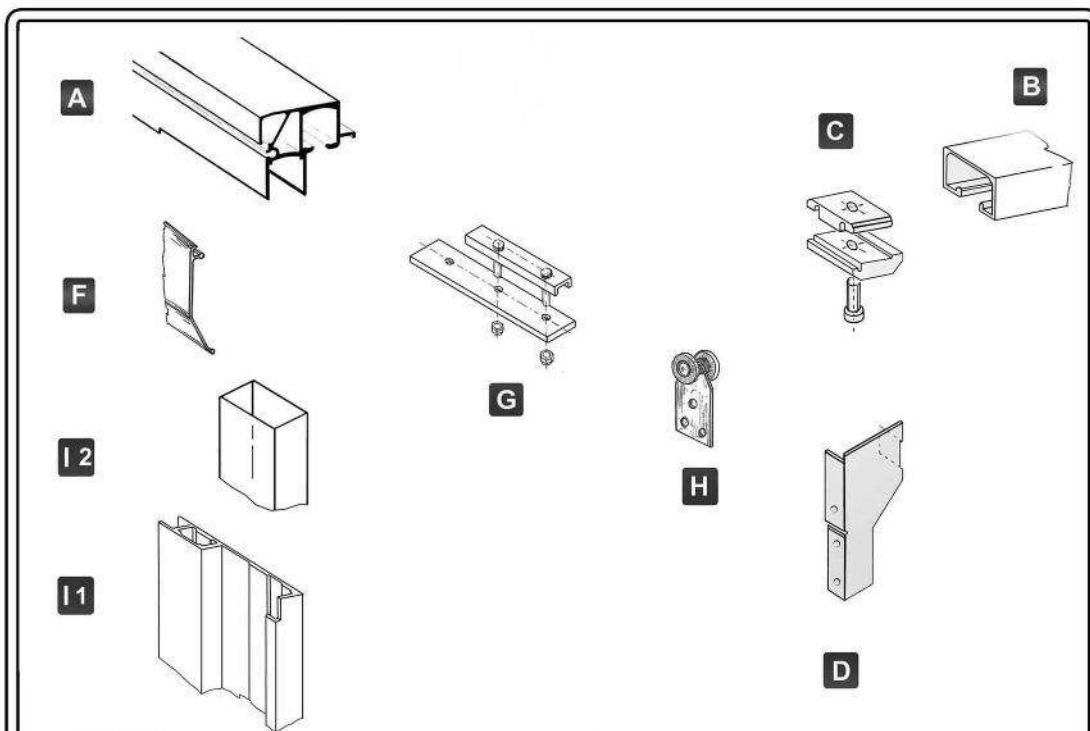

Art.	Descrizione / Description	Rif.
21-00058	Tegolone per centina <i>Aluminium profile for roof</i>	A
21-00060	Centina <i>Curtains side</i>	B
33-00099/C	Kit tasselli plan-kit <i>Kit rawplug plan-kit</i>	C
34-00150	Cuffia tegolone dx <i>Cap for curtains side right</i>	D
34-00151	Cuffia tegolone sx <i>Cap for curtains side left</i>	D
49-00027/N	Guarnizione pvc per tegolone art.21-00058 <i>Profile seal pvc art. 21-00058</i>	F
34-00155	Piastra per fissaggio montante <i>Plate for fixing pillar</i>	G
34-00125/N	Scorrevole 2 cuscinetti D.24 <i>Trolley for sliding courtain with 2 wheels D.24</i>	H
21-00064	Cantonale posteriore per centina <i>Comer rear for profile curtains</i>	I1
13-.....	Tube rettangolare x 30 <i>Rectangular pipes x 30</i>	I2

PROFILI LEGA 6005 - T6

ROOF STRUCTURE ALLOY 6005 - T6

PROFILI PER CENTINATURE

PROFILES FOR CURTAIN

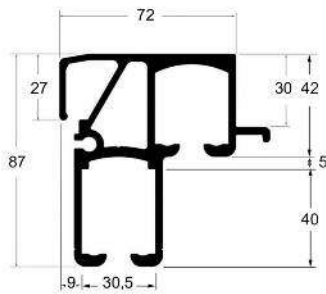

Art.	Lungh. Length	Kg/ml.
Tegolone per centina (21-00060)	4600	
21-00058		3,454
Aluminium profiles for roof (21-00060)	6000	

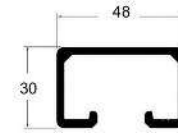

Art.	Lungh. Length	Kg/ml.
Centina per tegolone (21-00058)	6300	
21-00060		0,938
Profile curtain for (21-00058)	7250	

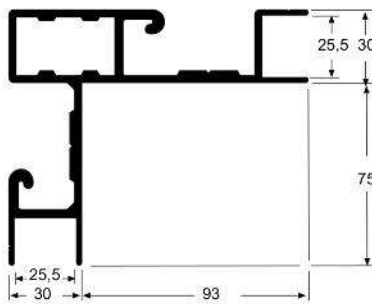

Art.	Lungh. Length	Kg/ml.
Cantonale anteriore per centinatura		
21-00062	5500	3,981
Corner front for profile curtain		

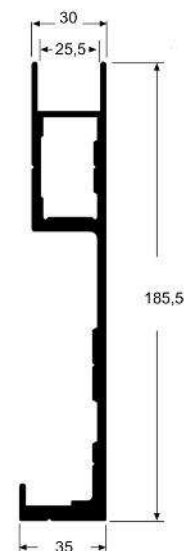

Art.	Lungh. Length	Kg/ml.
Cantonale posteriore per centinatura		
21-00064	5500	3,782
Corner rear for profile curtain		

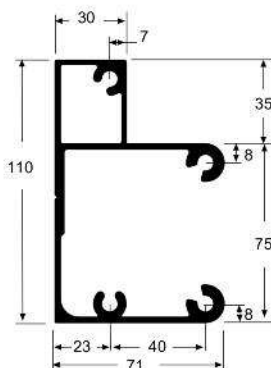

Art.	Lungh. Length	Kg/ml.
Sovra porta per centinatura		
21-00066	6600	3,188
Above the door for profile curtain		