

Profili sponda

Side board profiles

16

17



RE-ALL

LEGA 6060 - T6 - S/25mm.

ALLOY 6060 - T6 - Th.25mm

MONOPROFILO

SINGLE PROFILE

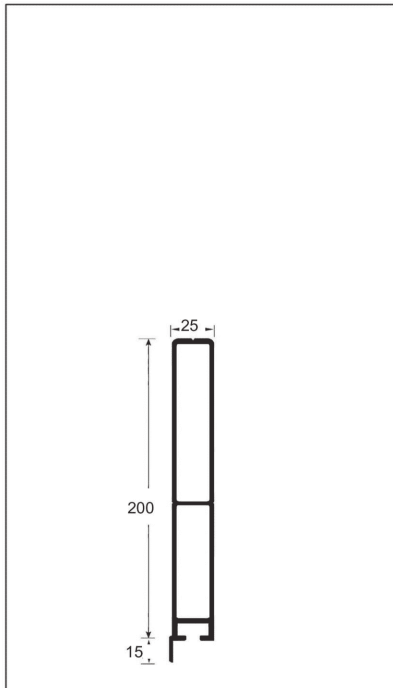

Art.	Lungh. Length	Kg/ml.
H. 200		
17-00000	7500	2,700
<i>H. 200</i>		

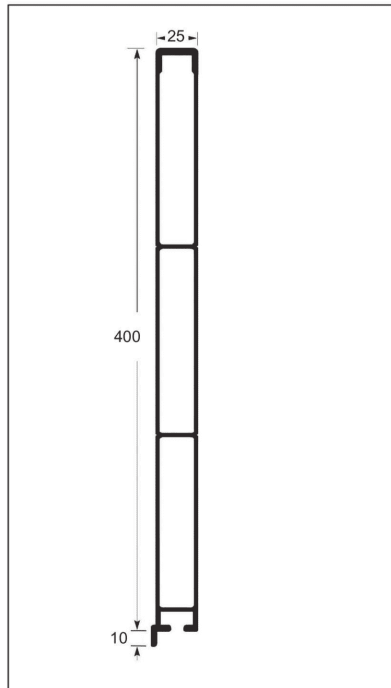

Art.	Lungh. Length	Kg/ml.
H. 400	6250	
16-00006		4,757
<i>H. 400</i>	7650	

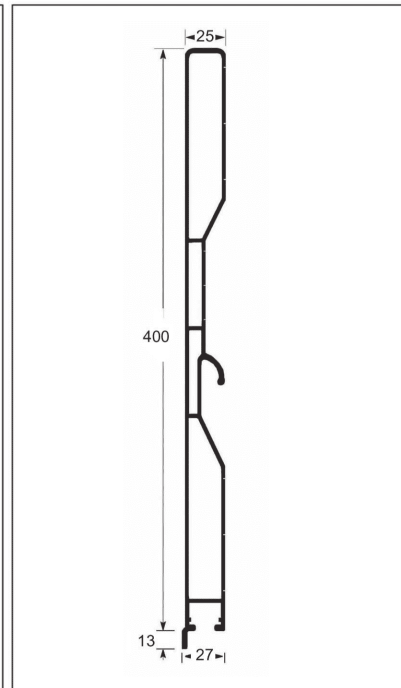

Art.	Lungh. Length	Kg/ml.
H. 400	6250	
16-00008	6750	4,500
<i>H. 400</i>	7650	

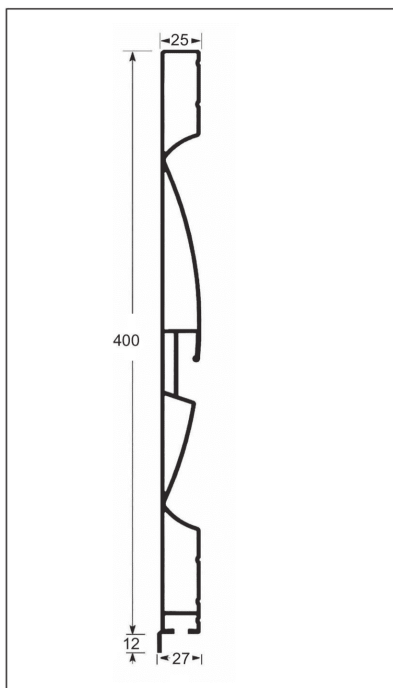

Art.	Lungh. Length	Kg/ml.
H. 400	6250	
16-00009	6750	4,754
<i>H. 400</i>	7650	

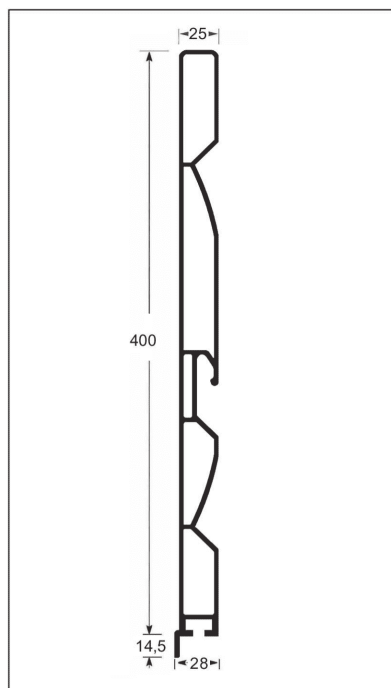

Art.	Lungh. Length	Kg/ml.
H. 400	6100	
16-00010	6750	4,593
<i>H. 400</i>	7650	

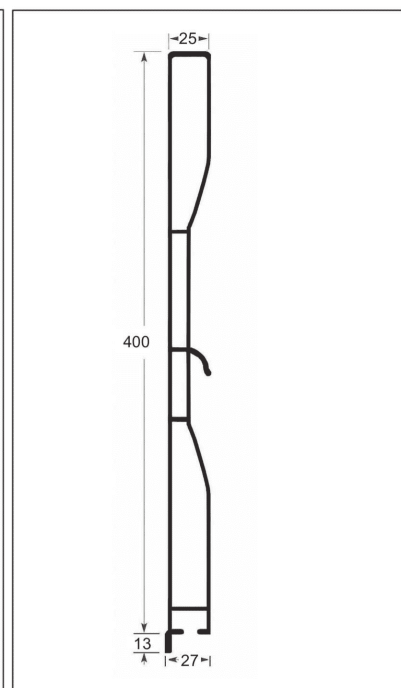

Art.	Lungh. Length	Kg/ml.
H. 400	4500	
16-00011	6250	4,406
	6750	
<i>H. 400</i>	7650	

SIDE BOARD PROFILES

LEGA 6060 - T6 - S/25mm.

ALLOY 6060 - T6 - Th.25mm

MONOPROFILO

SINGLE PROFILE

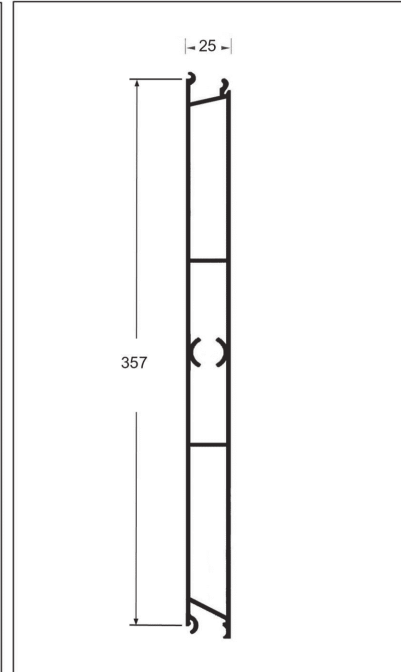
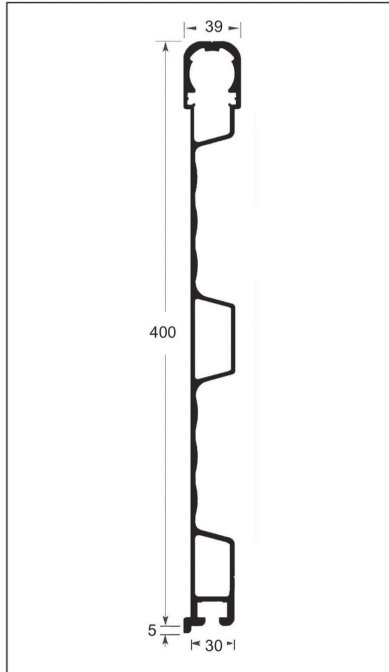
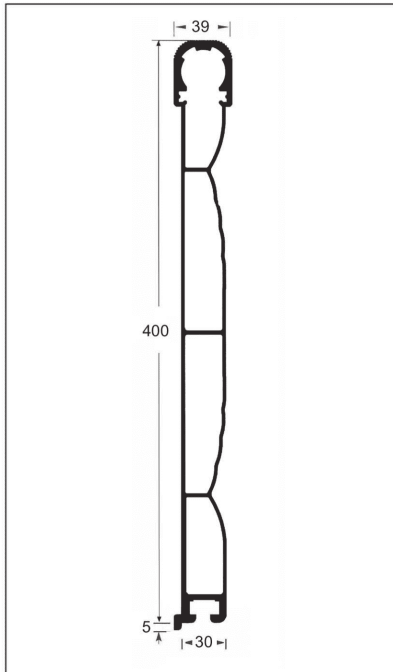

Art.	Lungh. Length	Kg/ml.
H. 400	4500	
16-00014	6250	6,160
<i>H. 400</i>	6750	

Art.	Lungh. Length	Kg/ml.
H. 400	6100	
16-00015		6,790
<i>H. 400</i>	6750	

Art.	Lungh. Length	Kg/ml.
H. 357		
16-00100		3,873
<i>H. 357</i>		

MONOPROFILO (A RICHIESTA)

SINGLE PROFILE (ON DEMAND)

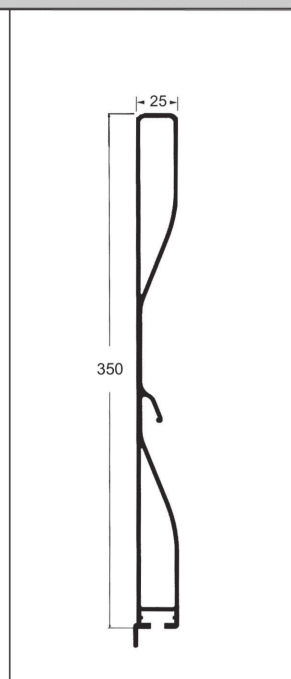
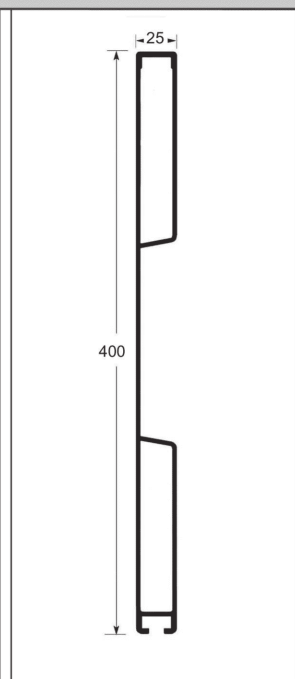
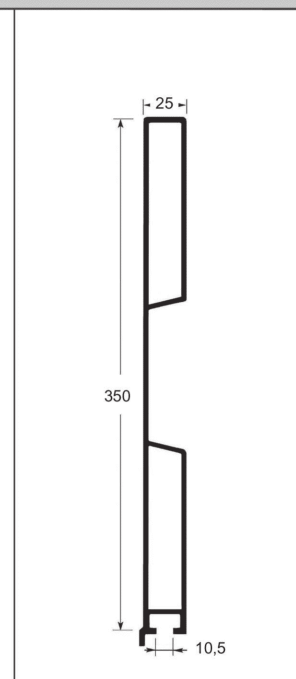
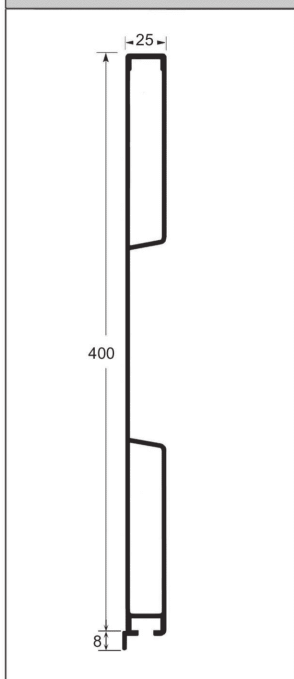

Art.	Lungh. Length	Kg/ml.
H. 400		
16-00002		4,317

Art.	Lungh. Length	Kg/ml.
H. 350		
16-00004		3,920

Art.	Lungh. Length	Kg/ml.
H. 400		
16-00005		4,130

Art.	Lungh. Length	Kg/ml.
H. 350		
16-00020		3,630

LEGA 6060 - T6 - S/25mm.

ALLOY 6060 - T6 - Th.25mm

PROFILO SUPERIORE

HIGHER PROFILE

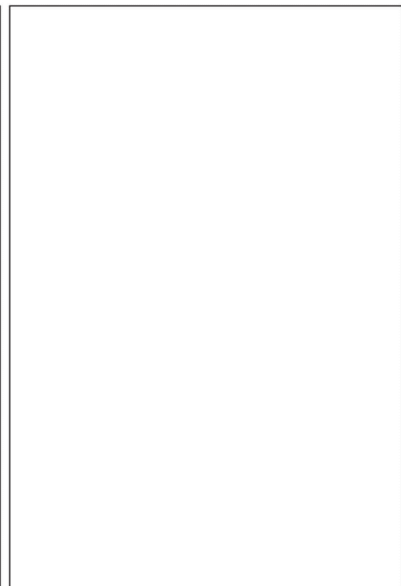
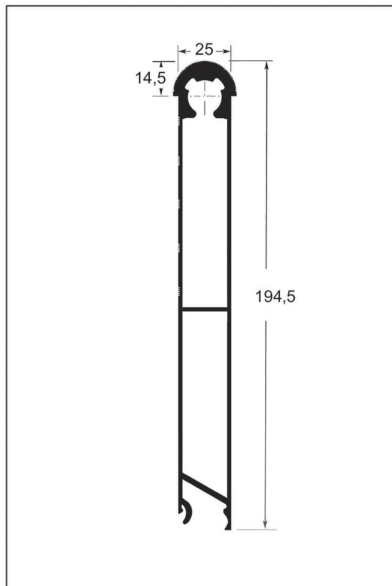
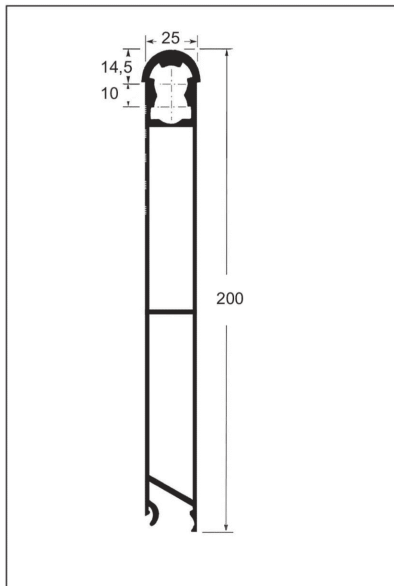

Art.	Lungh. Length	Kg/ml.
H.200 Arrotondato (2 posizioni) per il perno		
17-00001	6750	2,919
H. 200 Rounded (2 position) for pin	7650	

Art.	Lungh. Length	Kg/ml.
H.194,5 Arrotondato rinforzato	6100	
17-00005	6750	2,919
H.194,5 Rounded reinforced	7650	

Art.	Lungh. Length	Kg/ml.

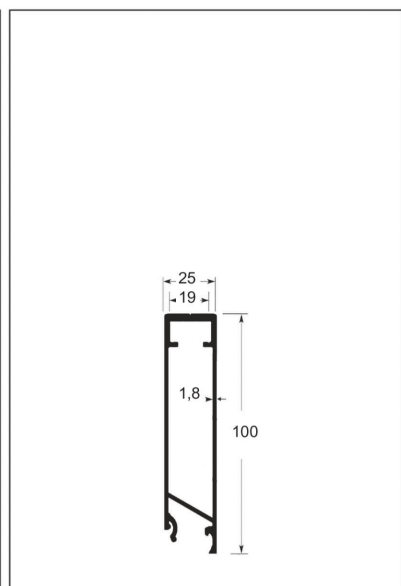
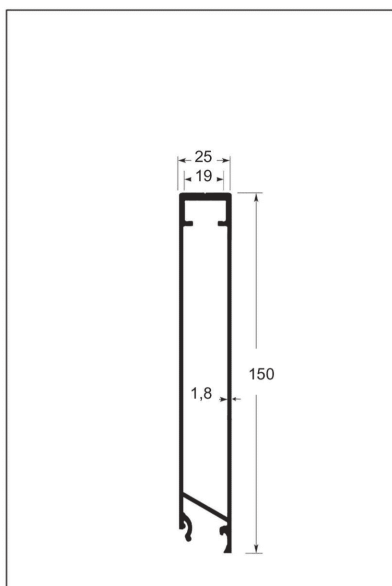
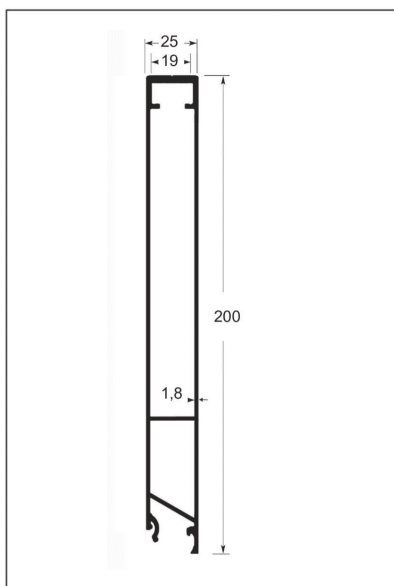

Art.	Lungh. Length	Kg/ml.
H. 200	6100	
17-00002	6750	2,280
H. 200	7650	

Art.	Lungh. Length	Kg/ml.
H. 150	6100	
17-00004		1,805
H. 150	7650	

Art.	Lungh. Length	Kg/ml.
H. 100	6100	
17-00006	6750	1,350
H. 100	7650	

SIDE BOARD PROFILES

LEGA 6060 - T6 - S/25mm.

ALLOY 6060 - T6 - Th.25mm

PROFILO INTERMEDIO

INTERMEDIATE PROFILE

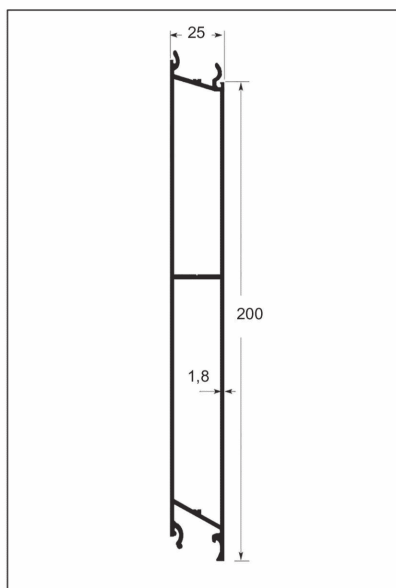

Art.	Lungh. Length	Kg/ml.
H. 200	6100	
17-00008	6750	2,354
H. 200	7650	

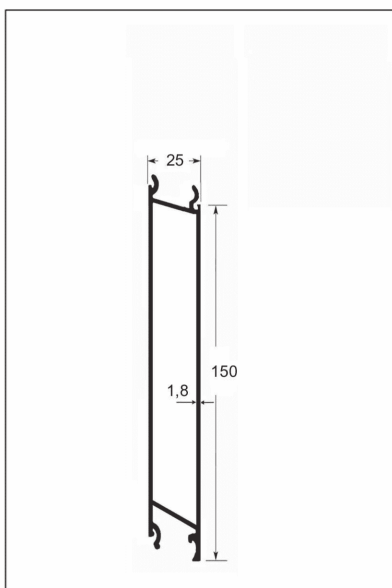

Art.	Lungh. Length	Kg/ml.
H. 150	6100	
17-00010		1,798
H. 150	7650	

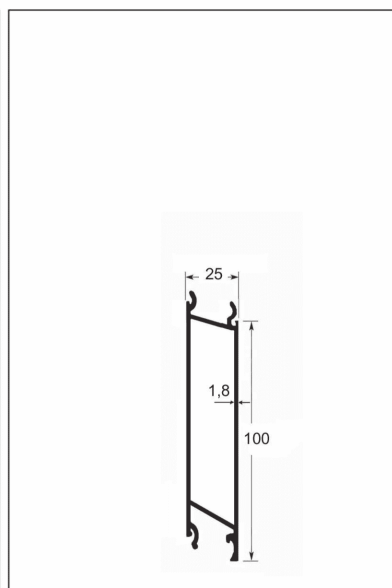

Art.	Lungh. Length	Kg/ml.
H. 100	6100	
17-00012	6750	1,328
H. 100	7650	

PROFILO TIR

TIR PROFILE

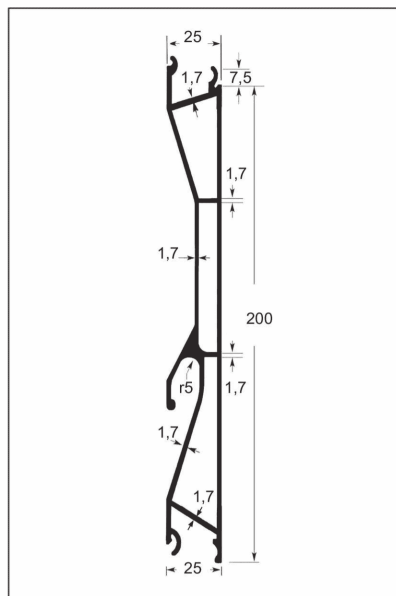

Art.	Lungh. Length	Kg/ml.
H.200 scatoletto con gancio	6100	
17-00013	6750	2,581
H.200 with hook	7650	

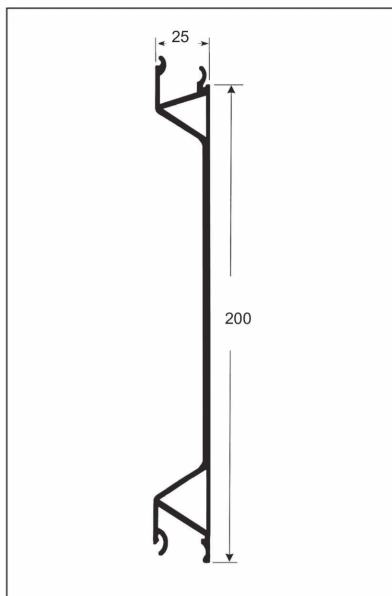

Art.	Lungh. Length	Kg/ml.
H. 200	6100	
17-00014	6750	2,190
H. 200	7650	

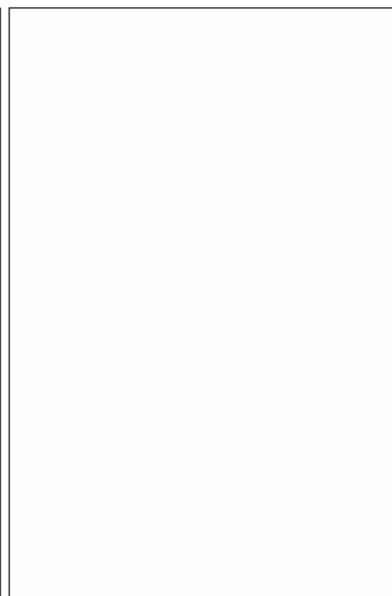

Art.	Lungh. Length	Kg/ml.

LEGA 6060 - T6 - S/25mm.

ALLOY 6060 - T6 - Th.25mm

PROFILO INFERIORE

LOWER PROFILE

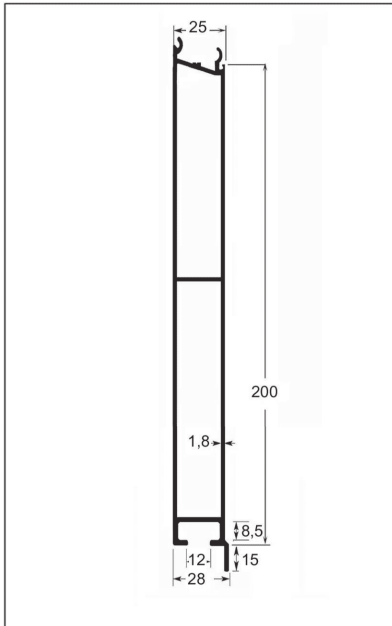

Art.	Lungh. Length	Kg/ml.
H. 200	6100	
17-00022	6750	2,555
H. 200	7650	

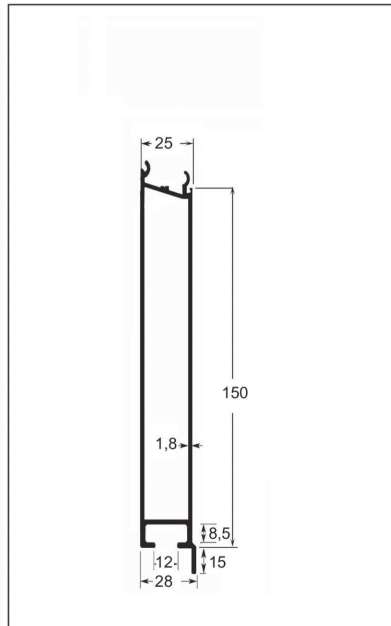

Art.	Lungh. Length	Kg/ml.
H. 150	6100	
17-00018		1,996
H. 150	7650	

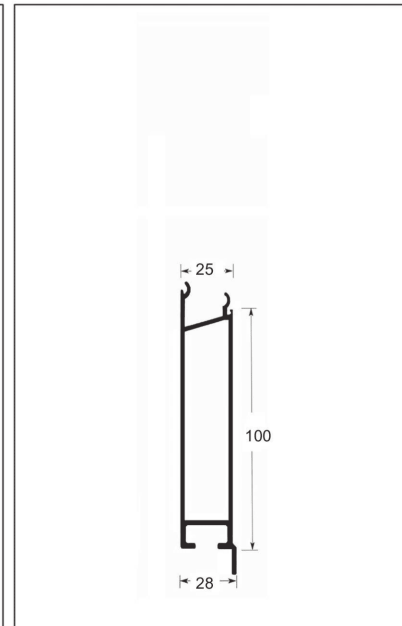

Art.	Lungh. Length	Kg/ml.
H. 100	6100	
17-00017		1,500
H. 100	7650	

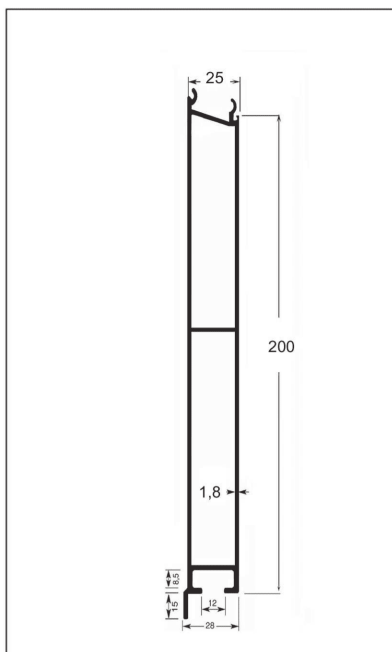

Art.	Lungh. Length	Kg/ml.
H. 200 con ala contrario	6100	
17-00024	6750	2,627
H. 200 (cotrary wing)	7650	

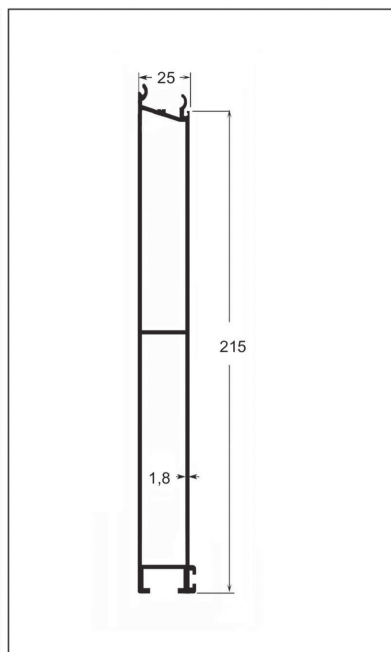

Art.	Lungh. Length	Kg/ml.
H. 215 con sede per guarnizione	6100	
17-00026	6750	2,530
H. 215 with housing for seal	7650	

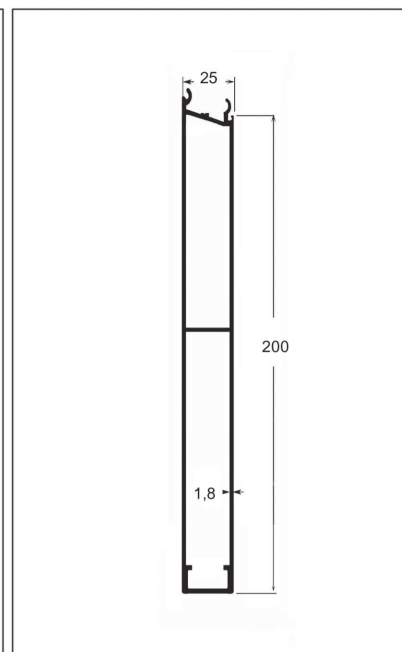

Art.	Lungh. Length	Kg/ml.
H. 200 chiuso	6100	
17-00028		2,448
H. 200 closed	7650	

SIDE BOARD PROFILES

LEGA 6060 - T6 - S/25mm.

ALLOY 6060 - T6 - Th.25mm

PROFILO INFERIORE

LOWER PROFILE

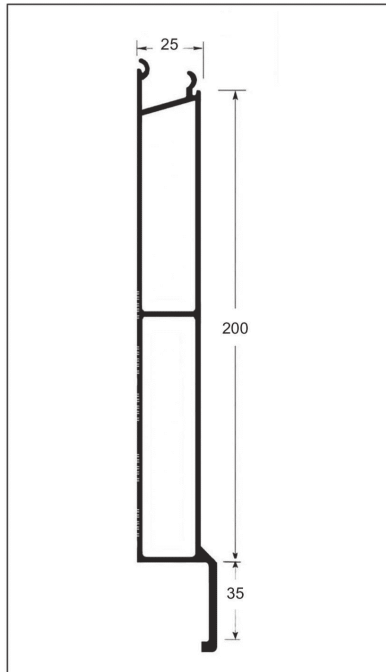
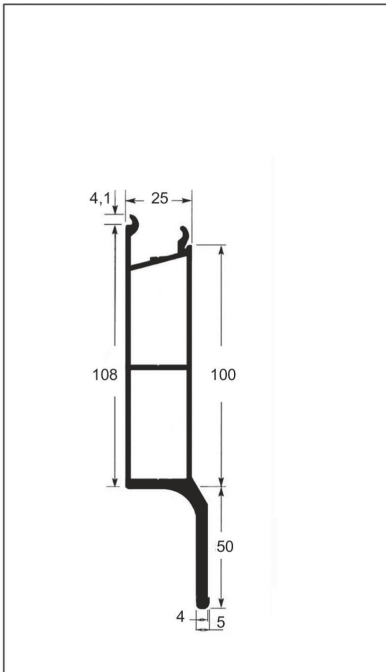

Art.	Lungh. Length	Kg/ml.
H.100 sovrasponda speciale		
17-00029/S	7650	2,207
<i>H.100 for extension side board special</i>		

Art.	Lungh. Length	Kg/ml.
H.200 Sovrasponda		
17-00027	7650	2,682
<i>H.200 for extension side board</i>		

Art.	Lungh. Length	Kg/ml.

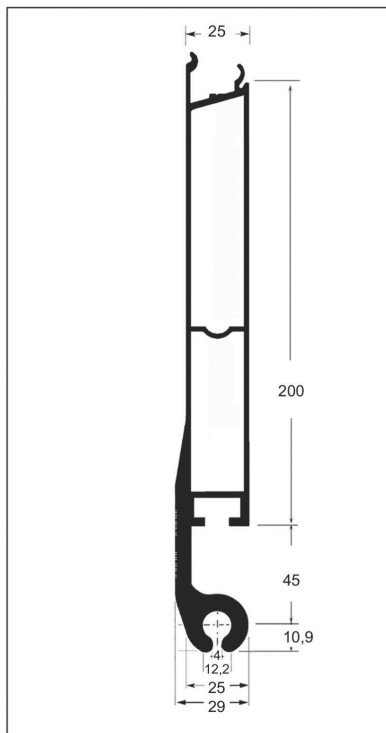
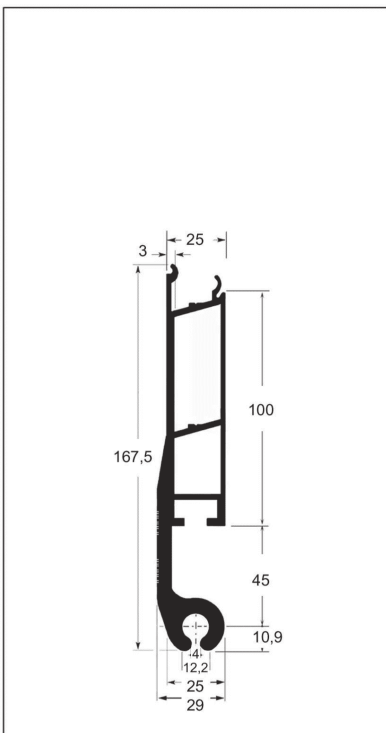

Art.	Lungh. Length	Kg/ml.
H.100+45 ribaltabile	6100	
17-00023	6750	3,470
<i>H.100+45 for tippers</i>	7650	

Art.	Lungh. Length	Kg/ml.
H.200+45 ribaltabile	6100	
17-00025		4,609
<i>H.200+45 for tippers</i>	7650	

Art.	Lungh. Length	Kg/ml.

LEGA 6060 - T6 - S/25mm.

T R 1

ALLOY 6060 - T6 - Th.25mm

PROFILO SUPERIORE

HIGHER PROFILE

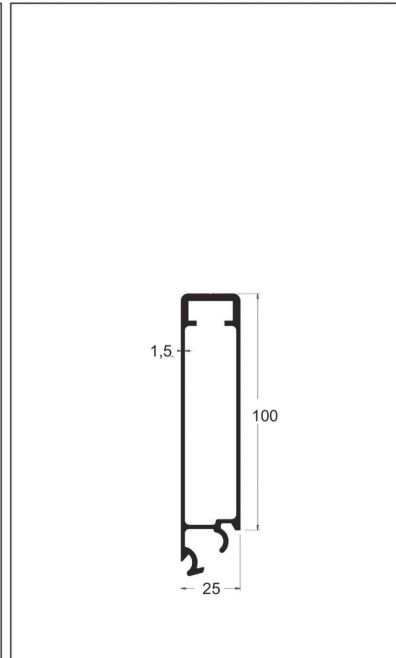
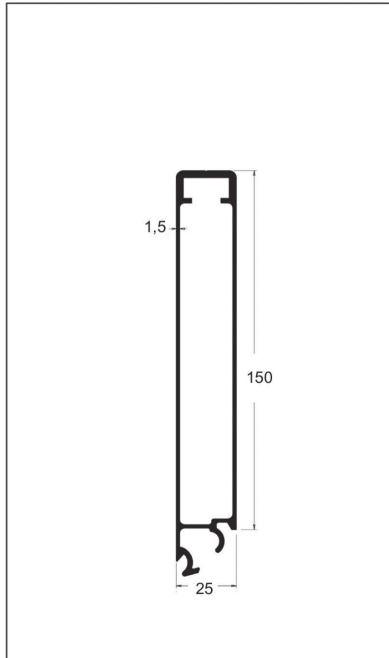
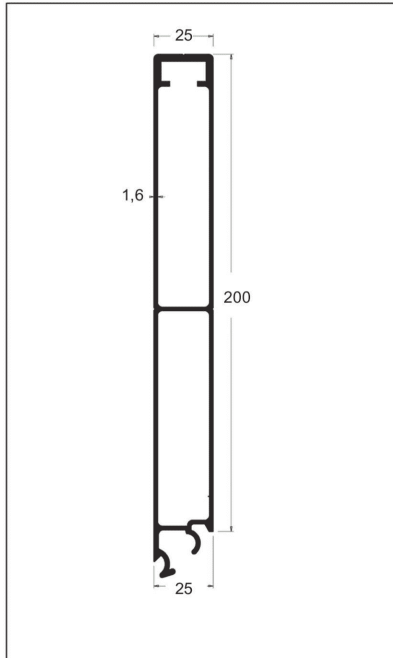

Art.	Lungh. Length	Kg/ml.
H. 200	6100	
17-00300	6750	2,455
<i>H. 200</i>	7650	

Art.	Lungh. Length	Kg/ml.
H. 150		
17-00304	7650	2,103
<i>H. 150</i>		

Art.	Lungh. Length	Kg/ml.
H. 100		
17-00306	6750	1,436
<i>H. 100</i>	7650	

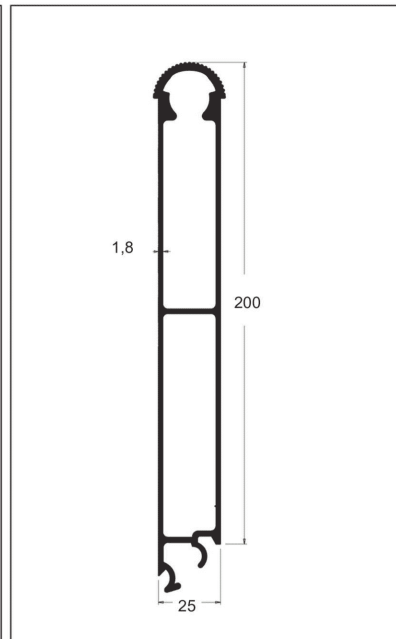
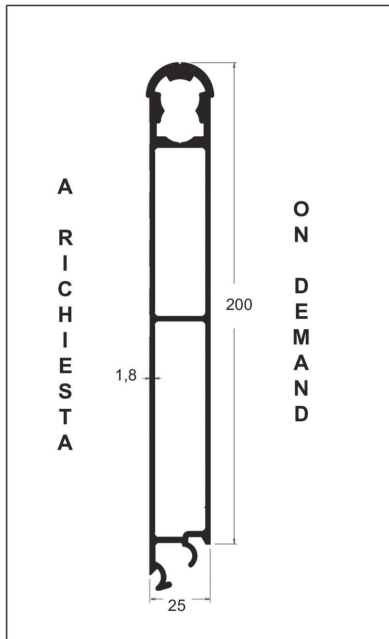
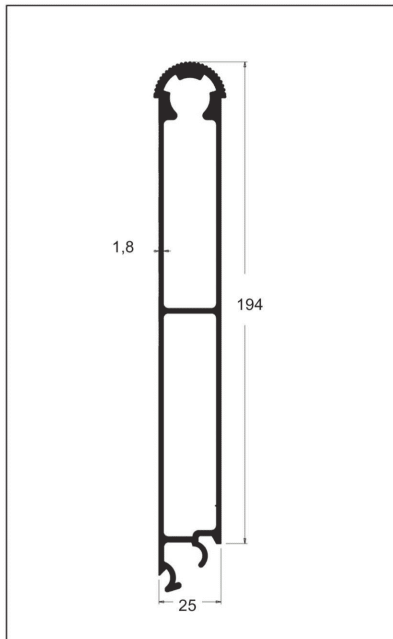

Art.	Lungh. Length	Kg/ml.
H.194 arrotondato	6100	
17-00302	6750	2,835
<i>H.194 rounded</i>	7650	

Art.	Lungh. Length	Kg/ml.
H. 200 arrotondato 2 posizioni		
17-00303		3,066
<i>H. 200 rounded</i>		

Art.	Lungh. Length	Kg/ml.
H. 200 arrotondato		
17-00301	6750	2,907
<i>H. 200 rounded</i>	7650	

SIDE BOARD PROFILES

LEGA 6060 - T6 - S/25mm.

T R 1

ALLOY 6060 - T6 - Th.25mm

PROFILO INTERMEDIO

INTERMEDIATE PROFILE

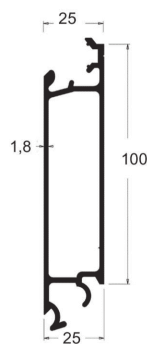
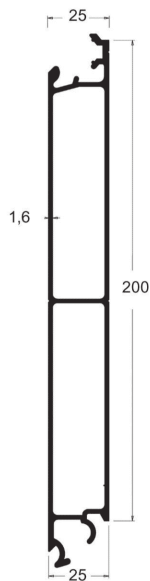

Art.	Lungh. Length	Kg/ml.
H. 200	6100	
17-00308	6750	2,366
H. 200	7650	

Art.	Lungh. Length	Kg/ml.
H. 100		
17-00312	6750	1,540
H. 100	7650	

Art.	Lungh. Length	Kg/ml.

PROFILO TIR

TIR PROFILE

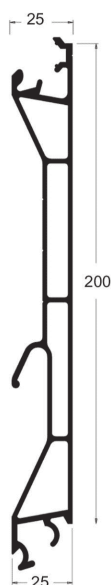
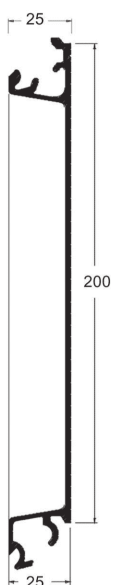

Art.	Lungh. Length	Kg/ml.
H. 200		
17-00314	6750	1,839
H. 200	7650	

Art.	Lungh. Length	Kg/ml.
H.200 scatolato con gancio	6100	
17-00315	6750	2,640
H.200 with hook	7650	

Art.	Lungh. Length	Kg/ml.

LEGA 6060 - T6 - S/25mm. **T R 1** ALLOY 6060 - T6 - Th.25mm

PROFILO INFERIORE **LOWER PROFILE**

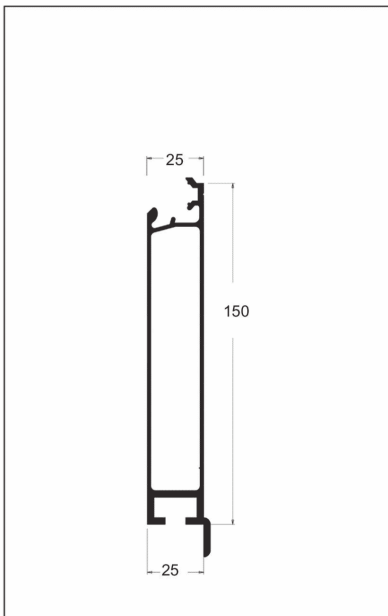

Art.	Lungh. Length	Kg/ml.
H. 150		
17-00318	7650	2,160
<i>H. 150</i>		

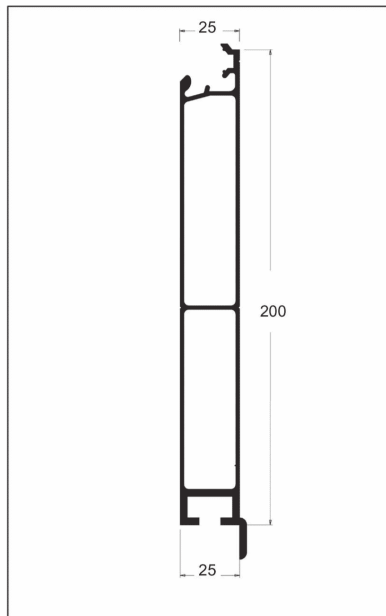

Art.	Lungh. Length	Kg/ml.
H. 200	6100	
17-00322	6750	2,514
<i>H. 200</i>	7650	

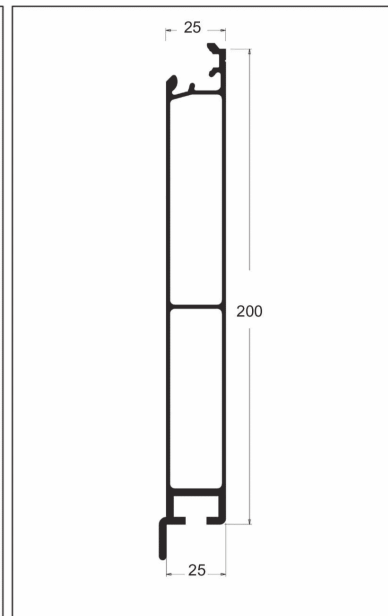

Art.	Lungh. Length	Kg/ml.
H. 200 con ala contraria		
17-00324	6750	2,389
<i>H. 200 contrary wing</i>	7650	

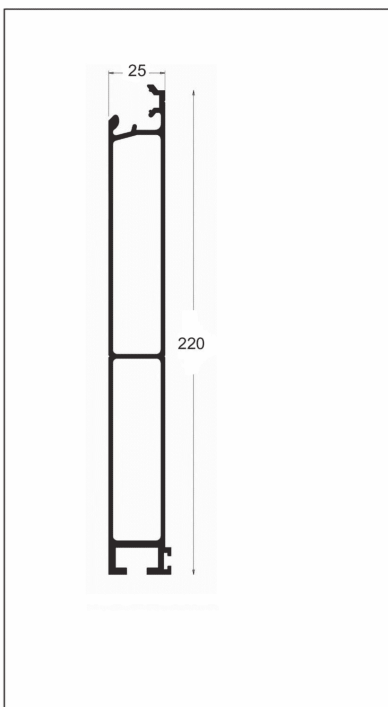

Art.	Lungh. Length	Kg/ml.
H.220 con sede per guarnizione	6100	
17-00326	6750	2,826
<i>H.220 with housing for seal</i>	7650	

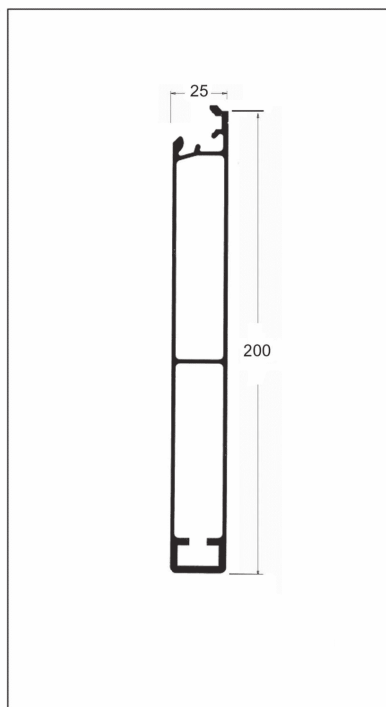

Art.	Lungh. Length	Kg/ml.
H. 200 chiuso		
17-00328	7650	2,236
<i>H. 200 closed</i>		



Art.	Lungh. Length	Kg/ml.

LEGA 6060 - T6 - S/25mm.

T R 1

ALLOY 6060 - T6 - Th.25mm

PROFILO INFERIORE

LOWER PROFILE

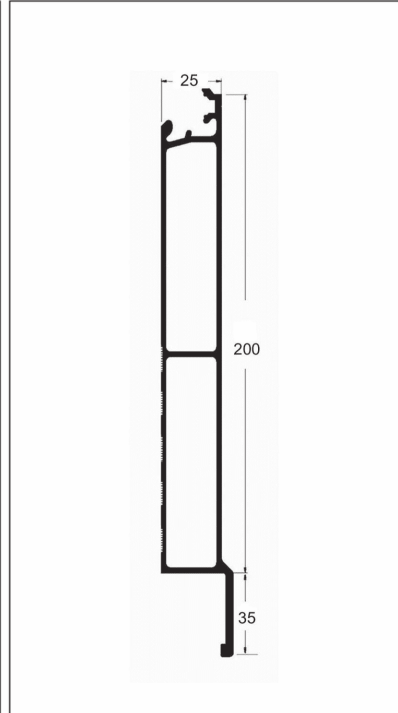
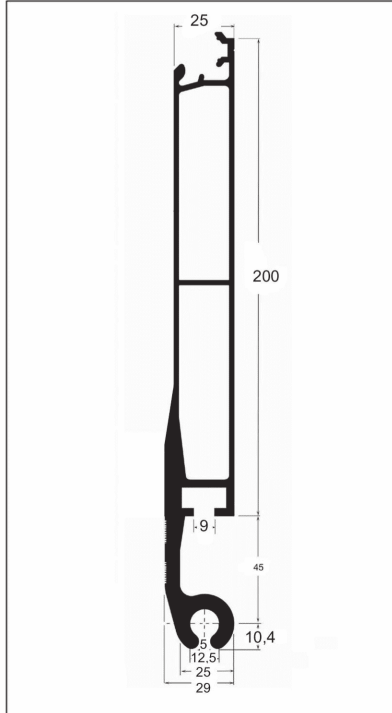
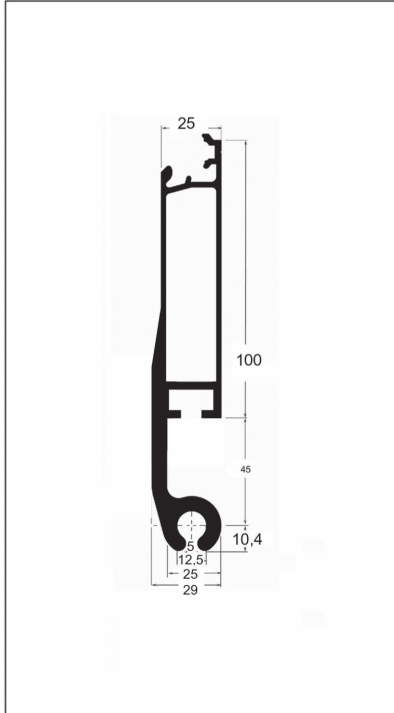

Art.	Lungh. Length	Kg/ml.
H.100+45 ribaltabile		
17-00331	6750	3,332
<i>H.100+45 for tippers</i>	7650	

Art.	Lungh. Length	Kg/ml.
H.200+45 ribaltabile		
17-00330	6750	4,368
<i>H.200+45 for tippers</i>	7650	

Art.	Lungh. Length	Kg/ml.
H.200 per sovrasponde		
17-00332	6750	2,653
<i>H.200 for extension side board</i>	7650	

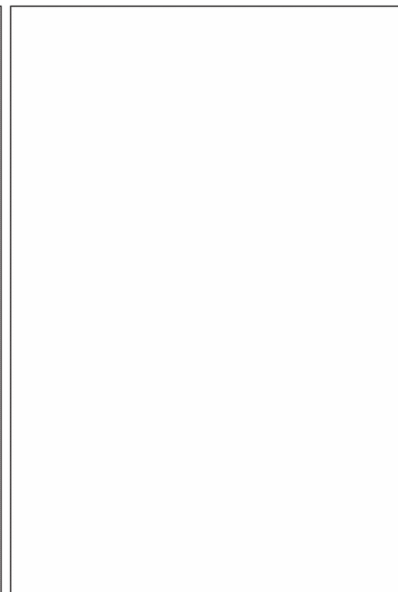
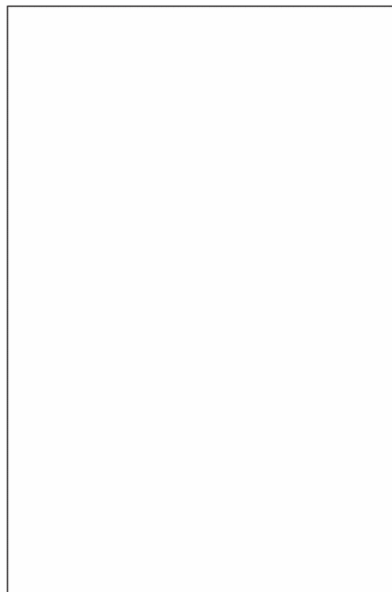
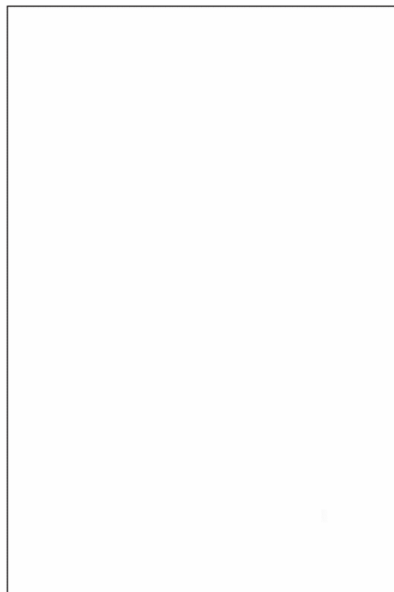

Art.	Lungh. Length	Kg/ml.

Art.	Lungh. Length	Kg/ml.

Art.	Lungh. Length	Kg/ml.

LEGA 6060 - T6

ALLOY 6060 - T6

PROFILO STECCA

PROFILE FOR CURTAINS



Art.	Lungh. Length	Kg/ml.
100 x 25	4300	
17-00031	6000	1,065
	6750	
100 x 25	7650	



Art.	Lungh. Length	Kg/ml.
120 x 25		
17-00032	6000	1,530
	6750	
120 x 25	7650	

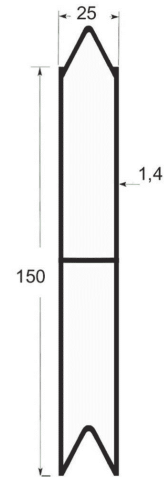

Art.	Lungh. Length	Kg/ml.
150 x 25		
17-00033	6000	1,580
	6750	
150 x 25	7650	



Art.	Lungh. Length	Kg/ml.
100 x 25		
17-00030	6750	1,107
100 x 25		

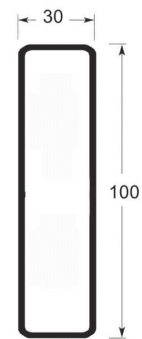

Art.	Lungh. Length	Kg/ml.
100 x 30	6000	
17-00130		1,310
100 x 30	7650	

SIDE BOARD PROFILES

LEGA 6060 - T6

ALLOY 6060 - T6

TESTATE

SIDE BOARD HEAD

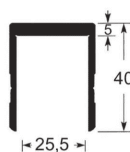

Art.	Lungh. Length	Kg/ml.
17-00034	6000	0,835

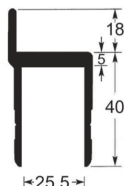

Art.	Lungh. Length	Kg/ml.
17-00036	6000	0,970

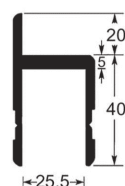

Art.	Lungh. Length	Kg/ml.
17-00038	6000	0,915

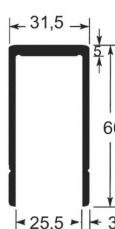

Art.	Lungh. Length	Kg/ml.
17-00040	6000	1,220

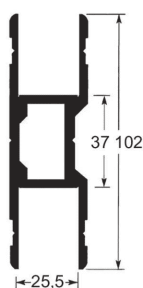

Art.	Lungh. Length	Kg/ml.
17-00046	6000	2,172

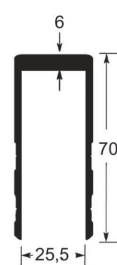

Art.	Lungh. Length	Kg/ml.
17-00047	6000	1,490

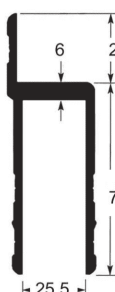

Art.	Lungh. Length	Kg/ml.
17-00048	6000	1,517

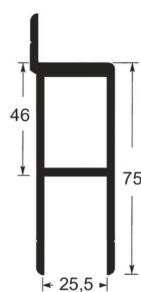

Art.	Lungh. Length	Kg/ml.
17-00052	7360	1,134

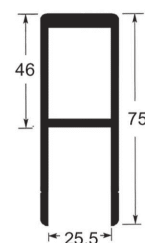

Art.	Lungh. Length	Kg/ml.
17-00054	7250	1,058

LEGA 6060 - T6

ALLOY 6060 - T6

Profilo terminale arrotondato

Side board head

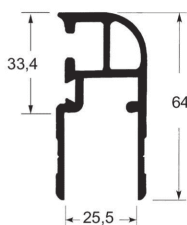

Art.	Lungh. Length	Kg/ml.
17-00057	6000	1,161

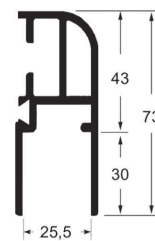

Art.	Lungh. Length	Kg/ml.
17-00060	6000	1,400

Testate S25/mm

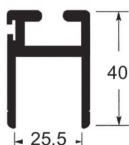

Art.	Lungh. Length	Kg/ml.
17-00056	6000	0,823

Side board head

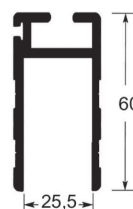

Art.	Lungh. Length	Kg/ml.
17-00058	6000	0,935

Testate S30/mm

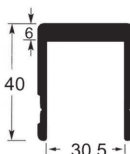

Art.	Lungh. Length	Kg/ml.
17-00120	6000	1,035

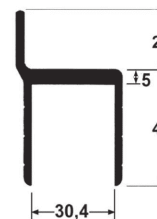

Art.	Lungh. Length	Kg/ml.
17-00122	6000	1,120

PROFILO PER CERNIERA
PROFILE FOR HINGE

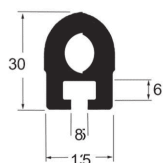

Art.	Lungh. Length	Kg/ml.
17-00050	5005	1,147

PROFILO "H"
PROFILE "H"

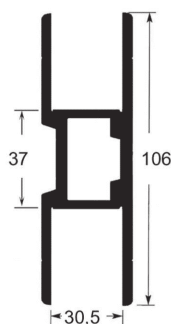

Art.	Lungh. Length	Kg/ml.
17-00126	6000	2,392

PROFILO "R"
PROFILE "R"

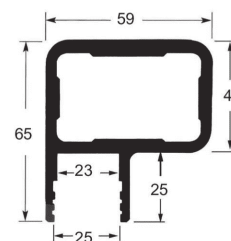

Art.	Lungh. Length	Kg/ml.
17-00128	6000	2,727

SIDE BOARD PROFILES

LEGA 6060 - T6 - S/30mm.

ALLOY 6060 - T6 - Th.30mm

(profili con incastro a rotazione e a spessore differenziato)

PROFILO SUPERIORE

HIGHER PROFILE

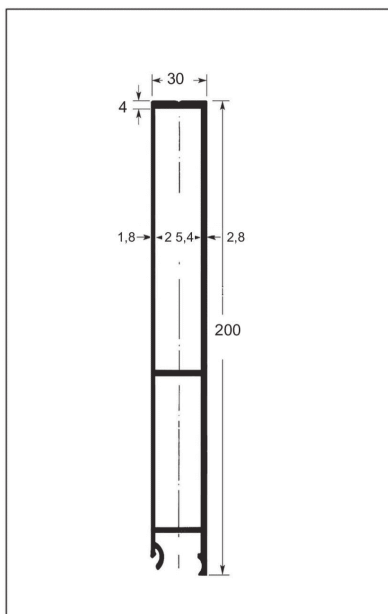

Art.	Lungh. Length	Kg/ml.
H. 200	6100	
17-00150		3,045
H. 200	7650	

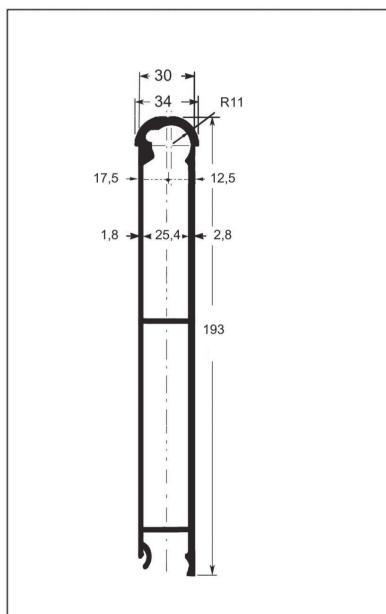

Art.	Lungh. Length	Kg/ml.
H.193 arrotondato	6100	
17-00152		3,050
H.193 rounded	7650	

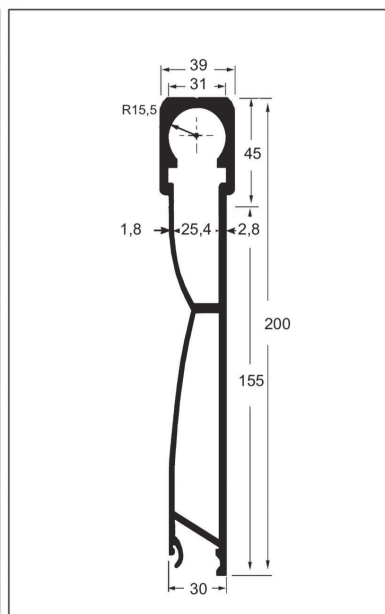

Art.	Lungh. Length	Kg/ml.
H.200 arrotondato	6100	
17-00153		3,992
H.200 rounded	7650	

PROFILO INTERMEDIO

INTERMEDIATE PROFILE

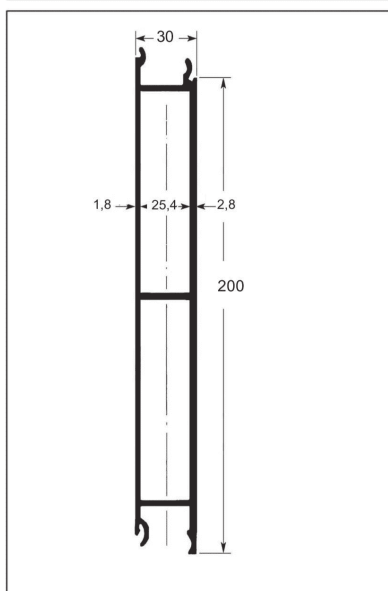

Art.	Lungh. Length	Kg/ml.
H. 200	6100	
17-00158		3,030
H. 200	7650	



Art.	Lungh. Length	Kg/ml.

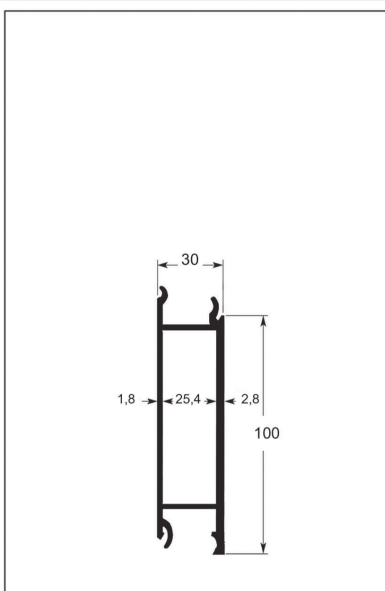

Art.	Lungh. Length	Kg/ml.
H. 100		
17-00162	7650	1,660
H. 100		

LEGA 6060 - T6 - S/30mm.

ALLOY 6060 - T6 - Th.30mm

(profili con incastro a rotazione e a spessore differenziato)

PROFILO INFERIORE

LOWER PROFILE

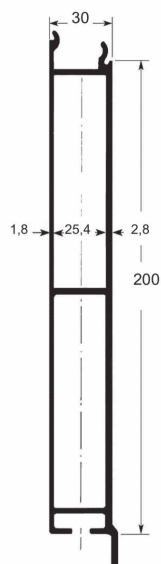

Art.	Lungh. Length	Kg/ml.
H. 200	6100	
17-00166		3,300
H. 200	7650	

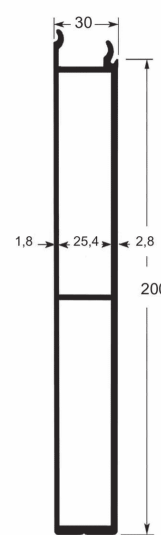

Art.	Lungh. Length	Kg/ml.
H. 200 chiuso		
17-00172	7650	3,150
H. 200 closed		

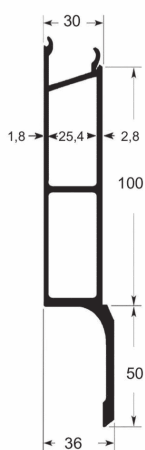

Art.	Lungh. Length	Kg/ml.
H. 100+50 sovrasponda	6100	
17-00174		2,505
H. 100+50 for extension side board	7650	

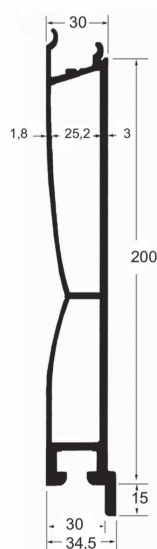

Art.	Lungh. Length	Kg/ml.
H.200 con battuta		
17-00182	7650	3,878
H. 200		

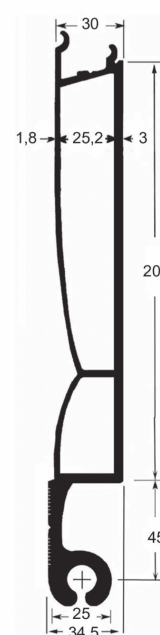

Art.	Lungh. Length	Kg/ml.
H.200 per ribaltabile		
17-00180	7650	5,018
H.200 for tippers		

LEGA 6063 - T6 - S/30mm.

T R 5

ALLOY 6063 - T6 - Th.30mm

PROFILO SUPERIORE

HIGHER PROFILE

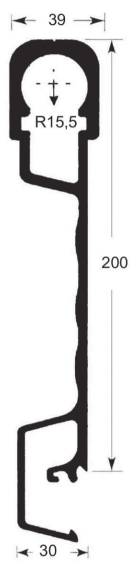

Art.	Lungh. Length	Kg/ml.
H.200	6100	
17-00202		4,700
H.200	7650	

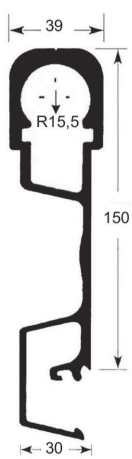

Art.	Lungh. Length	Kg/ml.
H.150		
17-00204	7650	4,700
H.150		

Art.	Lungh. Length	Kg/ml.

PROFILO INTERMEDIO

INTERMEDIATE PROFILE

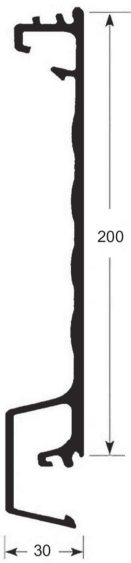

Art.	Lungh. Length	Kg/ml.
H.200	6100	
17-00208		3,340
H.200	7650	



Art.	Lungh. Length	Kg/ml.
H.150		
17-00206	7650	2,794
H.150		

Art.	Lungh. Length	Kg/ml.

LEGA 6063 - T6 - S/30mm.

T R 5

ALLOY 6063 - T6 - Th.30mm

PROFILO INFERIORE

LOWER PROFILE

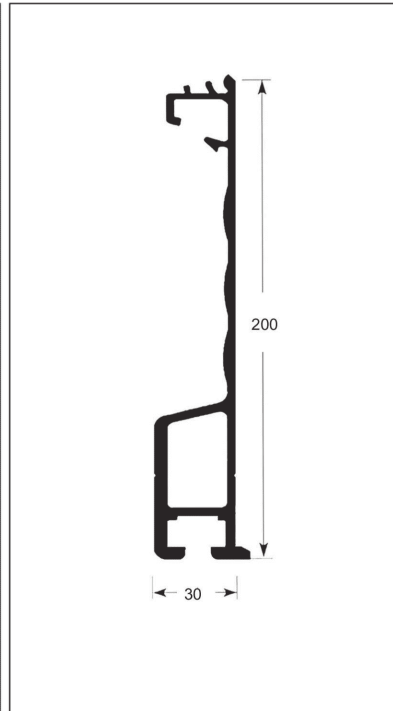
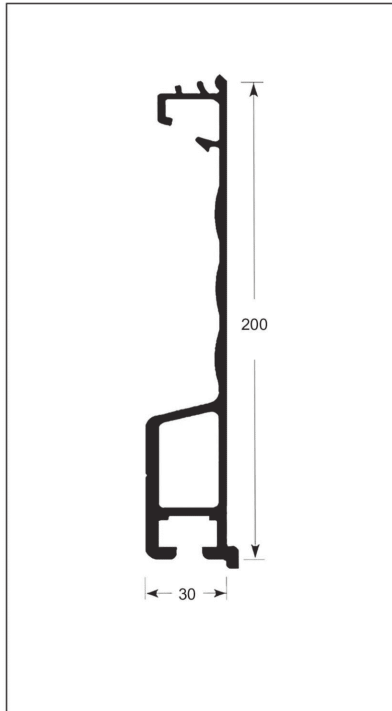
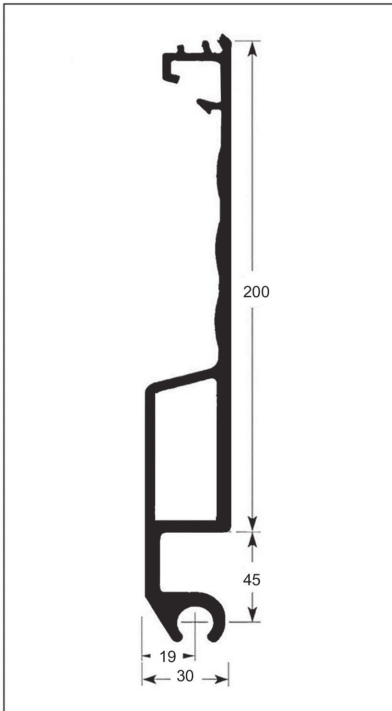

Art.	Lungh. Length	Kg/ml.
H.200 per ribaltabile		
17-00216	7650	5,313
<i>H.200 for tippers</i>		

Art.	Lungh. Length	Kg/ml.
H. 200	6100	
17-00212		3,985
<i>H. 200</i>	7650	

Art.	Lungh. Length	Kg/ml.
H.200 senza ala		
17-00214	7650	3,970
<i>H.200 without wing</i>		

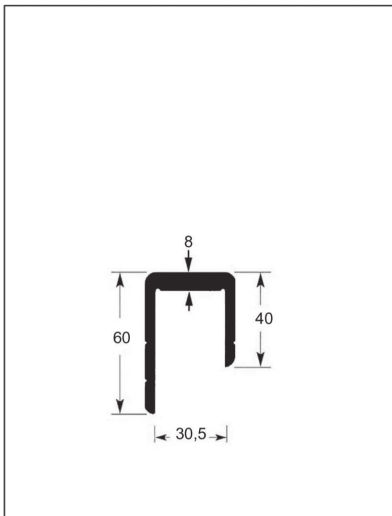

Art.	Lungh. Length	Kg/ml.
Testata		
17-00218	6100	1,817
<i>Side board head</i>		

Art.	Lungh. Length	Kg/ml.

Art.	Lungh. Length	Kg/ml.

LEGA 6060 - T6 - S/30mm.			T R 30			ALLOY 6060 - T6 - Th.30mm		
SUPERIORE <i>HIGHER</i>		INTERMEDIO <i>INTERMEDIATE</i>			INTERMEDIO <i>INTERMEDIATE</i>			
Art.	Lungh. Length	Kg/ml.	Art.	Lungh. Length	Kg/ml.	Art.	Lungh. Length	Kg/ml.
H.200 arrotondato	6200		H.100	6200		H. 100	6200	
17-00270	6750	4,587	17-00285	6750	1,796	17-00280	6750	3,200
H.200 rounded	7650		H. 100	7650		H. 100	7650	

INFERIORE <i>LOWER</i>				
Art.	Lungh. Length	Kg/ml.		
H. 200	6200			
17-00290	6750	3,920		
H. 200	7650			

INFERIORE <i>LOWER</i>				
Art.	Lungh. Length	Kg/ml.		
H.200+45 per rib.	6200			
17-00275	6750	5,229		
H.200+45 for tippers	7650			

LEGA 6060 - T6 - S/25mm.

T R 6

ALLOY 6060 - T6 - Th.25mm

A RICHIESTA / ON DEMAND

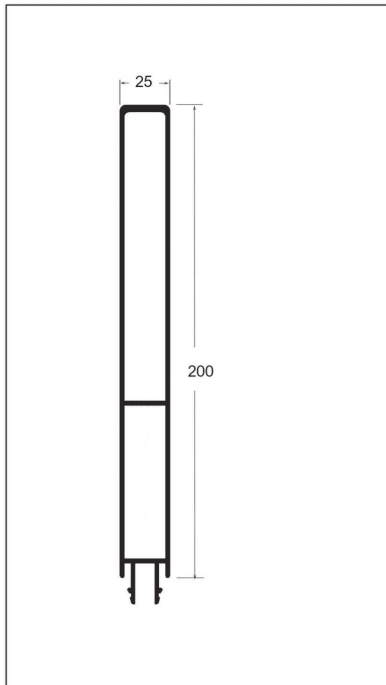

Art.	Lungh. Length	Kg/ml.
Superiore H.200		
17-00080		2,392
<i>Higher H.200</i>		

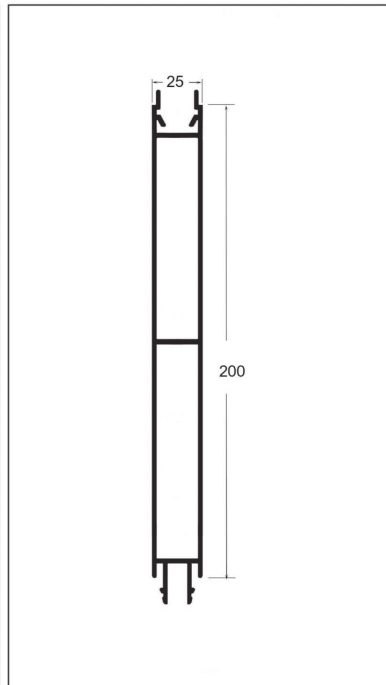

Art.	Lungh. Length	Kg/ml.
Intermedio H.200		
17-00086		2,449
<i>Intermediate H.200</i>		

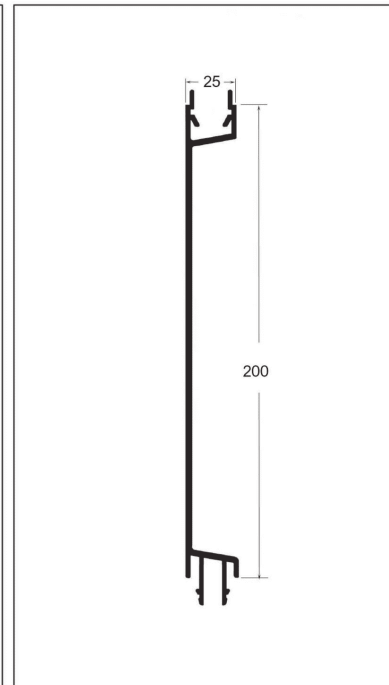

Art.	Lungh. Length	Kg/ml.
Tir H.200		
17-00092		2,190
<i>Tir H.200</i>		

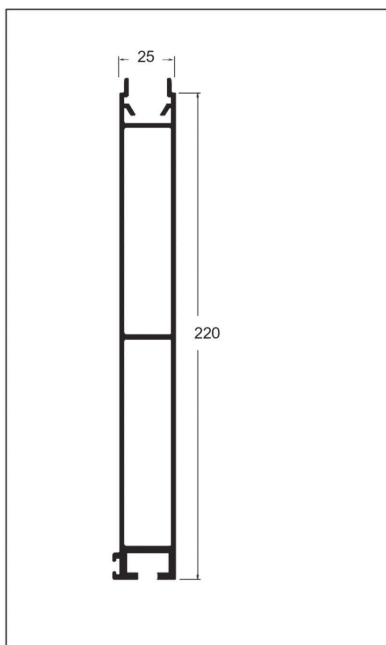

Art.	Lungh. Length	Kg/ml.
Inferiore H.220 con sede per guarniz.		
17-00098		2,764
<i>Lower H.220 with housing for seal</i>		

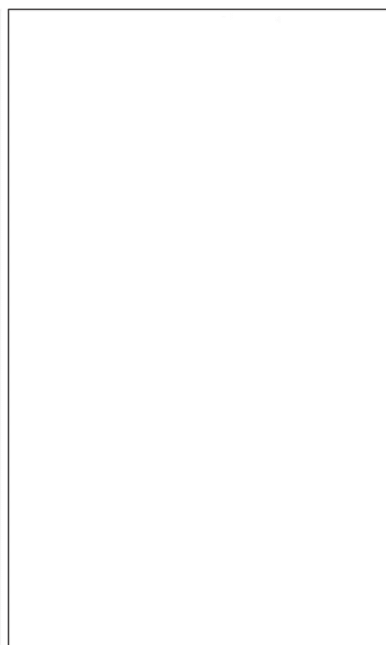

Art.	Lungh. Length	Kg/ml.



Art.	Lungh. Length	Kg/ml.

