

**Montanti  
accessori e innesti**

***Pillars  
accessories  
and fittings***

**30**



**RE-ALL**

Montanti a semplice apertura tipo leggero rovesciabili Sp.33mm.

Overturning pillars tickness 33 mm. - Light pillars for fixed load body

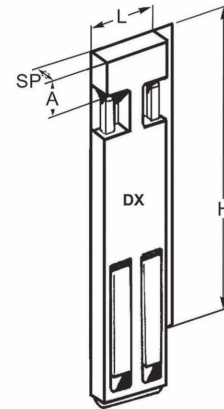
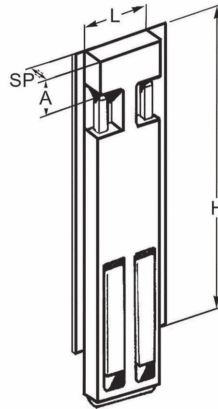
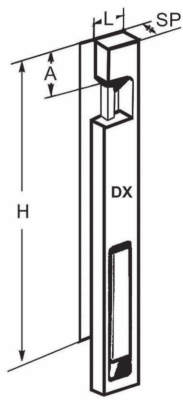

Ant.stretto / Front

Centrale / Central

Posteriore / Rear

Descrizione montante <i>Description pillar</i>	L. W.		H.400		H.500	
			Art.	A	Art.	A
Anteriore / Front	56	Dx / R.	30-00010	50	30-00020	150
Anteriore / Front	56	Sx / L.	30-00011	50	30-00021	150
Anteriore / Front	100	Dx / R.	30-00012	50	30-00022	150
Anteriore / Front	100	Sx / L.	30-00013	50	30-00023	150
Centrale / Central	100		30-00014	50	30-00024	150
Posteriore / Rear	100	Dx / R.	30-00015	50	30-00025	150
Posteriore / Rear	100	Sx / L.	30-00016	50	30-00026	150

Test. zinc. per montanti a semplice apertura tipo leggero rovesciabili sp.33

Galv.alumin.side board heads for overturning light pillars th.33mm.

Testata sp. 25 mm. <i>Side board head th.25mm.</i>			H. 400	H. 400	H. 500
			ALI 40 WINGS 40	ALI 60 WINGS 60	ALI 60 WINGS 60
Laterale Zinc. / Galv. Lateral	Dx / R.		30-00030	30-00038	30-00046
Laterale Zinc. / Galv. Lateral	Sx / L.		30-00031	30-00039	30-00047
Posteriore Zinc. / Galv. Rear	Dx / R.		30-00032	30-00040	30-00048
Posteriore Zinc. / Galv. Rear	Sx / L.		30-00033	30-00041	30-00049

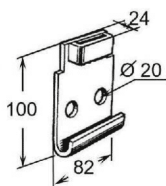
**Accessori per montanti a semplice apertura tipo leggero rovesciabili Sp.33mm****Galvanized accessories for overturning light pillars th.33****rovesciabili**

**Art. 30-00200**  
Piastra attacco montante leggero  
*Sock for light pillar*

(Kg.0,530)

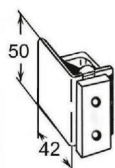

**Art. 30-00204**  
Taschetta laterale registrabile zinc.per montante con perno quadro s/25mm.  
*Galvanized side strike for pillar with square pin th.25mm.*

(Kg.0,128)

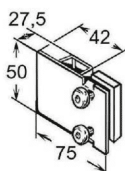

**Art. 30-00205**  
Taschetta posteriore registrabile zinc.per montante L=100 con perno quadro s/25mm.  
*Galvanized rear strike for pillar L=100 with square pin th.25mm.*

(Kg.0,154)

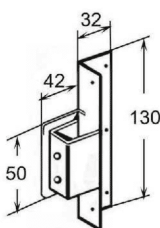

**Art. 30-00206**  
Taschetta laterale su angolare zincata per montante con perno quadro s/25mm.  
*Galvanized side strike for pillar with square pin th.25mm.*

(Kg.0,228)

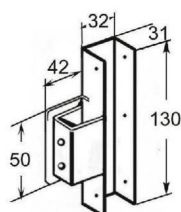

**Art. 30-00207**  
Taschetta posteriore su angolare zincata per montante con perno quadro s/25mm.  
*Galvanized rear strike for pillar with square pin th.25mm.*

(Kg.0,260)

**Montante tipo Francia sp.33mm.per centinature grandi volumi  
e Accessori Montanti tipo Francia H.3000**

***French type pillar th.33mm. for sliding curtains  
and Accessories for French type pillar H.3000***

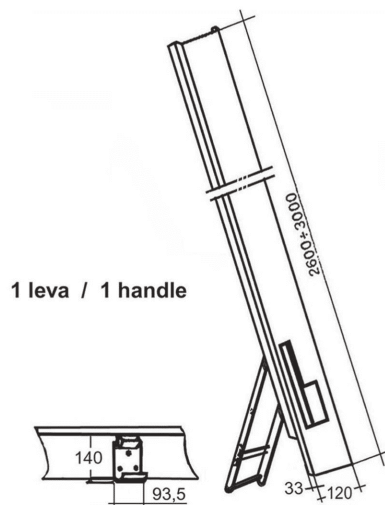

1 leva / 1 handle

**H.3000**

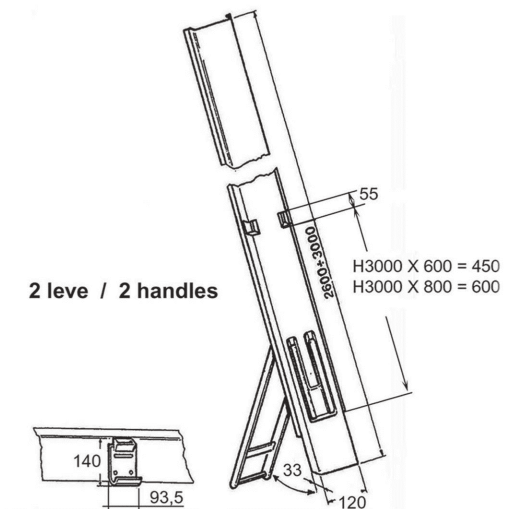

2 leve / 2 handles

Descrizione montante <i>Description pillar</i>	Leve Handle	H.3000	H.3000 X 600	H.3000 X 800
		Art.	Art.	Art.
Montante / Pillar	1	30-00124		
Parzialmente Inox / S.s. partially	1	30-00125		
Tutto inox / Totaly S.s.	1	30-00126		
Montante / Pillar	2		30-00124/6	
Parzialmente Inox / S.s. partially	2		30-00125/6	
Tutto inox / Totaly S.s.	2		30-00126/6	
Montante / Pillar	2			30-00124/8
Parzialmente Inox / S.s. partially	2			30-00125/8
Tutto inox / Totaly S.s.	2			30-00126/8

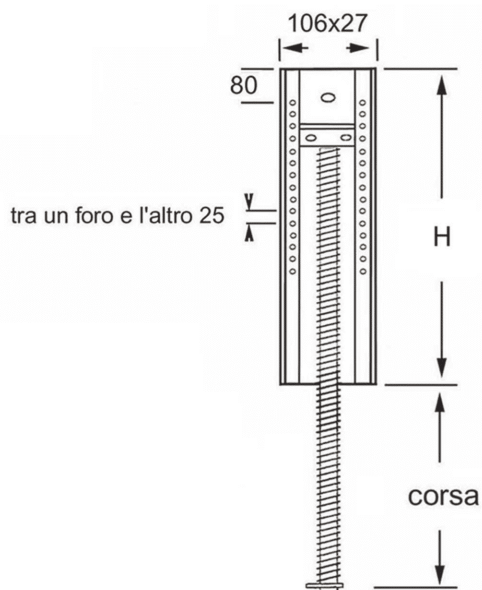

## Elastic Top

Art.	corsa	H
30-00128	500	750
30-00128/6	600	850
30-00128/8	800	1050

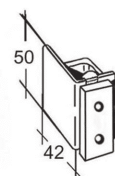

### Art.30-00203

Taschetta laterale registrabile inox per montante L=100 con perno quadro s/25mm.  
*Stainless steel adjustable side striker for pillar L=100 with square pin th.25mm.*

### Art. 30-00204

Taschetta laterale registrabile zincata per montante con perno quadro s/25mm.  
*Galvanized adjustable side striker for pillar with square pin th.25mm.*

Testata sp. 25 mm.		H. 600	H. 800
Side board head th.25mm.		ALI 60 - Wings 60	ALI 60 - Wings 60
Laterale Zinc. / Galv. Lateral	Dx / R.	30-00130	30-00133
Laterale Zinc. / Galv. Lateral	Sx / L.	30-00131	30-00134
Laterale inox / S.s. Lateral	Dx / R.	30-00135	30-00137
Laterale inox / S.s. Lateral	Sx / L.	30-00136	30-00138

### A richiesta / On demand

Versione inox fiorettato = aggiungere a fine articolo la F (es: 30-00..... /F)

S.s. anti-reflex treatment version = add at the end of Article F (es: 30-00..... /F)

## Dimensioni montanti a semplice apertura rovesciabili Sp.33mm.

### Dimensions overturning pillars th.33mm.for simple opening

Anteriore / Front	L = 56
Anteriore / Front (wide)	L = 120
Centrale / Central	L = 120
Posteriore / Rear	L = 120

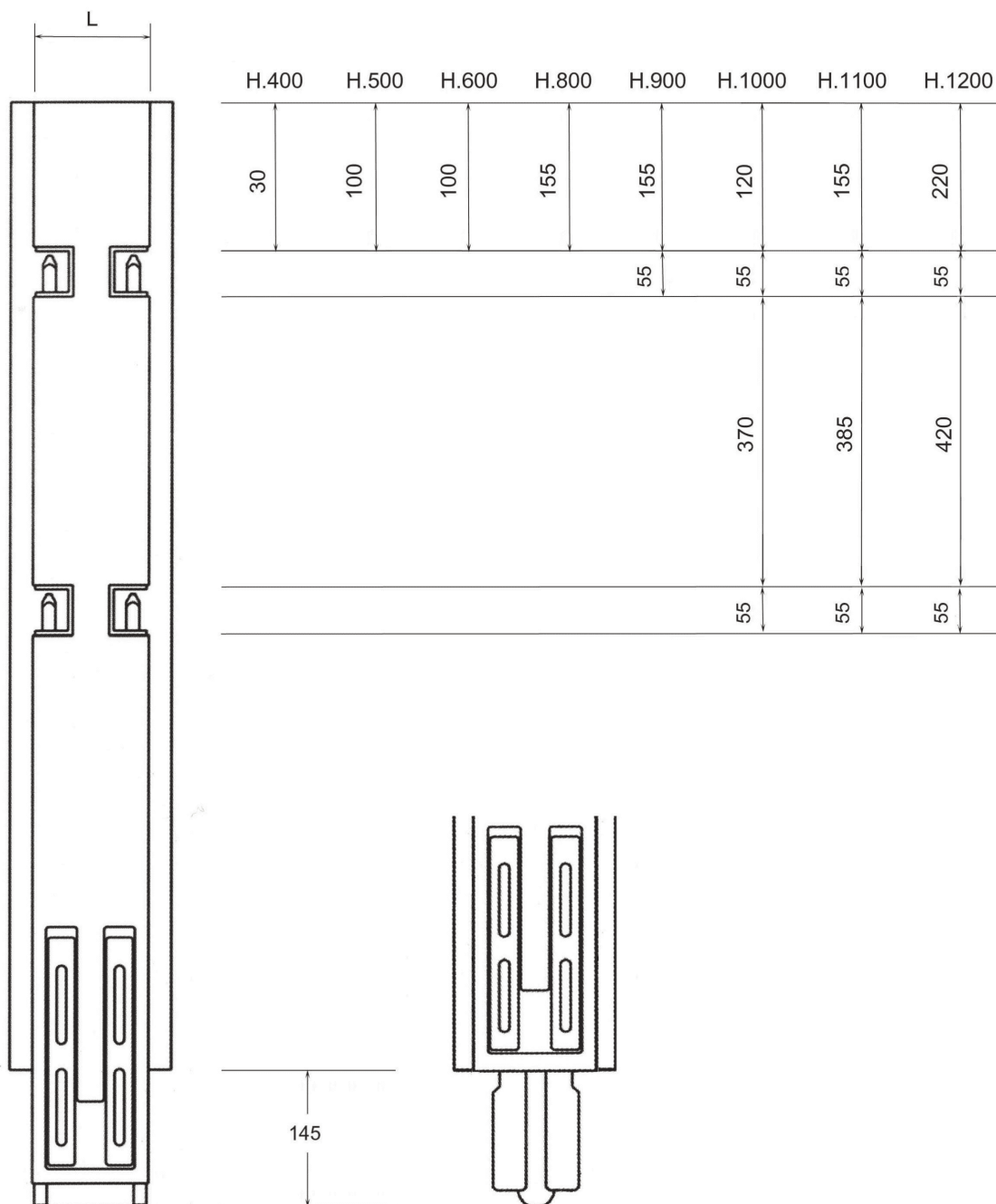

Montanti a semplice apertura rovesciabili Sp.33mm.

Overturning pillars Th.33mm. for simple opening

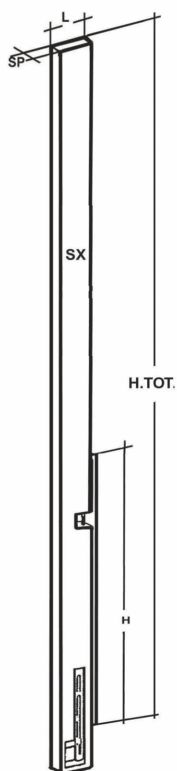

Anteriore alto  
High Front

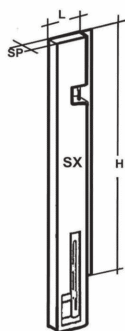

Anteriore stretto  
Front (tight)

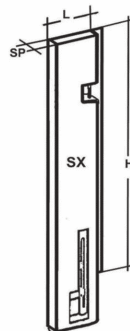

Anteriore largo  
Front (wide)

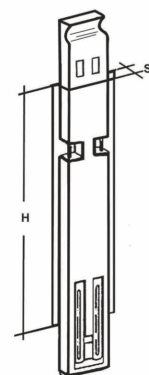
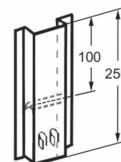

Centrale con snodo  
Central with joint

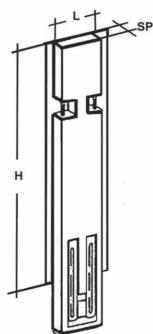

Centrale  
Central

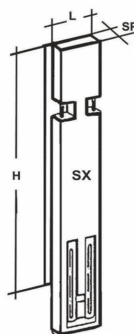

Posteriore  
Rear

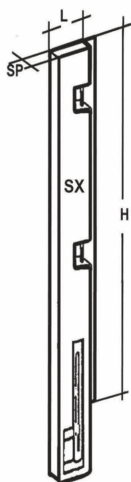

Anteriore stretto  
Front (tight)

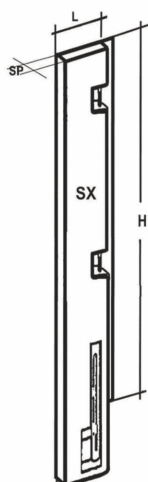

Anteriore largo  
Front (wide)

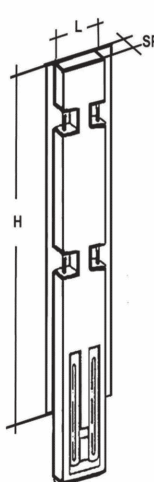

Centrale  
Central

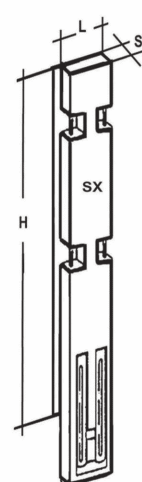

Posteriore  
Rear

**Montanti a semplice apertura rovesciabili Sp.33mm.**

***Overturning pillars Th.33mm. for simple opening***

Descrizione montante <i>Description pillar</i>	L. W.		H.400	H.500	H.600
			Art.	Art.	Art.
Anteriore / <i>Front</i> - H.tot.1600	85	Dx / R.	30-00050/L	.....	.....
Anteriore / <i>Front</i> - H.tot.1600	85	Sx / L.	30-00051/L	.....	.....
Anteriore / <i>Front</i> - H.tot.1800	85	Dx / R.	.....	30-00058/L	.....
Anteriore / <i>Front</i> - H.tot.1800	85	Sx / L.	.....	30-00059/L	.....
Ant. Sganciabile / <i>Front detachable</i>	56	Dx / R.	30-00050/SG	30-00058/SG	30-00067/SG
Ant. Sganciabile / <i>Front detachable</i>	56	Sx / L.	30-00051/SG	30-00059/SG	30-00068/SG
Anteriore / <i>Front</i>	56	Dx / R.	30-00050	30-00058	30-00067
Anteriore / <i>Front</i>	56	Sx / L.	30-00051	30-00059	30-00068
Anteriore / <i>Front</i>	120	Dx / R.	30-00052	30-00060	30-00069
Anteriore / <i>Front</i>	120	Sx / L.	30-00053	30-00061	30-00070
Centrale / <i>Central</i>	120		30-00054	30-00062	30-00071
Posteriore / <i>Rear</i>	120	Dx / R.	30-00055	30-00063	30-00072
Posteriore / <i>Rear</i>	120	Sx / L.	30-00056	30-00064	30-00073
Centr.con snodo / <i>Centr.with joint</i>	120			30-00065	30-00074

Descrizione montante <i>Description pillar</i>	L. W.		H.800	H.900	H.1000
			Art.	Art.	Art.
Ant. Sganciabile / <i>Front detachable</i>	56	Dx / R.	30-00076/SG	30-00085/SG	30-00094/SG
Ant. Sganciabile / <i>Front detachable</i>	56	Sx / L.	30-00077/SG	30-00086/SG	30-00095/SG
Anteriore / <i>Front</i>	56	Dx / R.	30-00076	30-00085	30-00094
Anteriore / <i>Front</i>	56	Sx / L.	30-00077	30-00086	30-00095
Anteriore / <i>Front</i>	120	Dx / R.	30-00078	30-00087	30-00096
Anteriore / <i>Front</i>	120	Sx / L.	30-00079	30-00088	30-00097
Centrale / <i>Central</i>	120		30-00080	30-00089	30-00098
Posteriore / <i>Rear</i>	120	Dx / R.	30-00081	30-00090	30-00099
Posteriore / <i>Rear</i>	120	Sx / L.	30-00082	30-00091	30-00100
Centr.con snodo / <i>Centr.with joint</i>	120		30-00083	30-00092	30-00101

Descrizione montante <i>Description pillar</i>	L. W.		H.1100	H.1200	
			Art.	Art.	
Ant. Sganciabile / <i>Front detachable</i>	56	Dx / R.	30-00103/SG	30-00112/SG	
Ant. Sganciabile / <i>Front detachable</i>	56	Sx / L.	30-00104/SG	30-00113/SG	
Anteriore / <i>Front</i>	56	Dx / R.	30-00103	30-00112	
Anteriore / <i>Front</i>	56	Sx / L.	30-00104	30-00113	
Anteriore / <i>Front</i>	120	Dx / R.	30-00105	30-00114	
Anteriore / <i>Front</i>	120	Sx / L.	30-00106	30-00115	
Centrale / <i>Central</i>	120		30-00107	30-00116	
Posteriore / <i>Rear</i>	120	Dx / R.	30-00108	30-00117	
Posteriore / <i>Rear</i>	120	Sx / L.	30-00109	30-00118	
Centr.con snodo / <i>Centr.with joint</i>	120		30-00110	30-00119	

## Montanti a semplice apertura rovesciabili Sp.33mm. (parzialmente inox)

## Overturning pillars th.33mm. simple opening (partially s.s.)

Descrizione montante <i>Description pillar</i>	L. W.		H.400	H.500	H.600
			Art.	Art.	Art.
Anteriore / Front - H.tot.1600	85	Dx / R.	30-00400/L	.....	.....
Anteriore / Front - H.tot.1600	85	Sx / L.	30-00401/L	.....	.....
Anteriore / Front - H.tot.1800	85	Dx / R.	.....	30-00408/L	.....
Anteriore / Front - H.tot.1800	85	Sx / L.	.....	30-00409/L	.....
Ant. Sganciabile / Front detachable <i>hable</i>	56	Dx / R.	30-00400/SG	30-00408/SG	30-00416/SG
Ant. Sganciabile / Front detachable	56	Sx / L.	30-00401/SG	30-00409/SG	30-00417/SG
Anteriore / Front	56	Dx / R.	30-00400	30-00408	30-00416
Anteriore / Front	56	Sx / L.	30-00401	30-00409	30-00417
Anteriore / Front	120	Dx / R.	30-00402	30-00410	30-00418
Anteriore / Front	120	Sx / L.	30-00403	30-00411	30-00419
Centrale / Central	120		30-00404	30-00412	30-00420
Posteriore / Rear	120	Dx / R.	30-00405	30-00413	30-00421
Posteriore / Rear	120	Sx / L.	30-00406	30-00414	30-00422
Centr.con snodo / Centr.with joint	120		.....	30-00415	30-00423

Descrizione montante <i>Description pillar</i>	L. W.		H.800	H.900	H.1000
			Art.	Art.	Art.
Ant. Sganciabile / Front detachable	56	Dx / R.	30-00424/SG	30-00432/SG	30-00440/SG
Ant. Sganciabile / Front detachable	56	Sx / L.	30-00425/SG	30-00433/SG	30-00441/SG
Anteriore / Front	56	Dx / R.	30-00424	30-00432	30-00440
Anteriore / Front	56	Sx / L.	30-00425	30-00433	30-00441
Anteriore / Front	120	Dx / R.	30-00426	30-00434	30-00442
Anteriore / Front	120	Sx / L.	30-00427	30-00435	30-00443
Centrale / Central	120		30-00428	30-00436	30-00444
Posteriore / Rear	120	Dx / R.	30-00429	30-00437	30-00445
Posteriore / Rear	120	Sx / L.	30-00430	30-00438	30-00446
Centr.con snodo / Centr.with joint	120		30-00431	30-00439	30-00447

Descrizione montante <i>Description pillar</i>	L. W.		H.1100	H.1200	
			Art.	Art.	
Ant. Sganciabile / Front detachable	56	Dx / R.	30-00448/SG	30-00456/SG	
Ant. Sganciabile / Front detachable	56	Sx / L.	30-00449/SG	30-00457/SG	
Anteriore / Front	56	Dx / R.	30-00448	30-00456	
Anteriore / Front	56	Sx / L.	30-00449	30-00457	
Anteriore / Front	120	Dx / R.	30-00450	30-00458	
Anteriore / Front	120	Sx / L.	30-00451	30-00459	
Centrale / Central	120		30-00452	30-00460	
Posteriore / Rear	120	Dx / R.	30-00453	30-00461	
Posteriore / Rear	120	Sx / L.	30-00454	30-00462	
Centr.con snodo / Centr.with joint	120		30-00455	30-00463	

**A richiesta / On demand**

Versione parzialmente inox fioretato = aggiungere a fine articolo la F (es: 30-00..... /F)

Partially S.s. anti-reflex treatment version = add at the end of Article F (es: 30-00..... /F)

**Montanti a semplice apertura rovesciabili Sp.33mm. ( Totalmente inox)**

**Overturning pillars th.33mm. simple opening ( Totally s.s.)**

Descrizione montante <i>Description pillar</i>	L. W.		H.400	H.500	H.600
			Art.	Art.	Art.
Anteriore / Front - H.tot.1600	85	Dx / R.	30-00400/TI/L	.....	.....
Anteriore / Front - H.tot.1600	85	Sx / L.	30-00401/TI/L	.....	.....
Anteriore / Front - H.tot.1800	85	Dx / R.	.....	30-00408/TI/L	.....
Anteriore / Front - H.tot.1800	85	Sx / L.	.....	30-00409/TI/L	.....
Ant. Sganciabile / Front detachable	56	Dx / R.	30-00400/TI/SG	30-00408/TI/SG	30-00416/TI/SG
Ant. Sganciabile / Front detachable	56	Sx / L.	30-00401/TI/SG	30-00409/TI/SG	30-00417/TI/SG
Anteriore / Front	56	Dx / R.	30-00400/TI	30-00408/TI	30-00416/TI
Anteriore / Front	56	Sx / L.	30-00401/TI	30-00409/TI	30-00417/TI
Anteriore / Front	120	Dx / R.	30-00402/TI	30-00410/TI	30-00418/TI
Anteriore / Front	120	Sx / L.	30-00403/TI	30-00411/TI	30-00419/TI
Centrale / Central	120		30-00404/TI	30-00412/TI	30-00420/TI
Posteriore / Rear	120	Dx / R.	30-00405/TI	30-00413/TI	30-00421/TI
Posteriore / Rear	120	Sx / L.	30-00406/TI	30-00414/TI	30-00422/TI
Centr.con snodo / Centr.with joint	120		.....	30-00415/TI	30-00423/TI

Descrizione montante <i>Description pillar</i>	L. W.		H.800	H.900	H.1000
			Art.	Art.	Art.
Ant. Sganciabile / Front detachable	56	Dx / R.	30-00424/TI/SG	30-00432/TI/SG	30-00440/TI/SG
Ant. Sganciabile / Front detachable	56	Sx / L.	30-00425/TI/SG	30-00433/TI/SG	30-00441/TI/SG
Anteriore / Front	56	Dx / R.	30-00424/TI	30-00432/TI	30-00440/TI
Anteriore / Front	56	Sx / L.	30-00425/TI	30-00433/TI	30-00441/TI
Anteriore / Front	120	Dx / R.	30-00426/TI	30-00434/TI	30-00442/TI
Anteriore / Front	120	Sx / L.	30-00427/TI	30-00435/TI	30-00443/TI
Centrale / Central	120		30-00428/TI	30-00436/TI	30-00444/TI
Posteriore / Rear	120	Dx / R.	30-00429/TI	30-00437/TI	30-00445/TI
Posteriore / Rear	120	Sx / L.	30-00430/TI	30-00438/TI	30-00446/TI
Centr.con snodo / Centr.with joint	120		30-00431/TI	30-00439/TI	30-00447/TI

Descrizione montante <i>Description pillar</i>	L. W.		H.1100	H.1200	
			Art.	Art.	
Ant. Sganciabile / Front detachable	56	Dx / R.	30-00448/TI/SG	30-00456/TI/SG	
Ant. Sganciabile / Front detachable	56	Sx / L.	30-00449/TI/SG	30-00457/TI/SG	
Anteriore / Front	56	Dx / R.	30-00448/TI	30-00456/TI	
Anteriore / Front	56	Sx / L.	30-00449/TI	30-00457/TI	
Anteriore / Front	120	Dx / R.	30-00450/TI	30-00458/TI	
Anteriore / Front	120	Sx / L.	30-00451/TI	30-00459/TI	
Centrale / Central	120		30-00452/TI	30-00460/TI	
Posteriore / Rear	120	Dx / R.	30-00453/TI	30-00461/TI	
Posteriore / Rear	120	Sx / L.	30-00454/TI	30-00462/TI	
Centr.con snodo / Centr.with joint	120		30-00455/TI	30-00463/TI	

**A richiesta / On demand**

**Versione Totalmente inox fiorettato = aggiungere a fine articolo la F (es: 30-00..... /TI/F)**

**Totally S.s. anti-reflex treatment version = add at the end of Article F (es: 30-00..... /TI/F)**

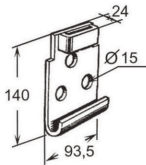
**Accessori zinc. per Montanti a semplice apertura rovesciabili*****Galv. accessories per Overturning pillars for simple opening*****Art. 30-00201**

(Kg.0,767)

Piastra attacco montante normale

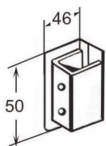
*Sock for normal pillar***Art. 30-00210**

(Kg.0,078)

Taschetta originale grezza

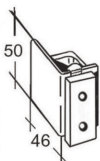
*Side strike for pillar***Art. 30-00215**

(Kg.0,128)

Taschetta laterale registrabile zinc.s/25

*Galv. side strike for pillar (th.25mm) adjustable***Art. 30-00218**

(Kg.0,120)

Taschetta laterale modificata registrabile

per testate posteriori/arrotondate zinc.

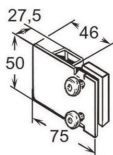
*Galvanized side strike for pillar (th.25mm)**adjustable for round side board heads***Art. 30-00216**

(Kg.0,150)

Taschetta posteriore registrabile zinc.s/25

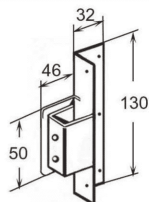
*Galv. rear strike for pillar (th25mm) adjustable***Art. 30-00211**

(Kg.0,232)

Taschetta laterale su angolare zinc.s/25

*Galv. side strike with angle for pillar (th.25mm)***Art. 30-00212**

(Kg.0,242)

Taschetta laterale su angolare zinc.s/30

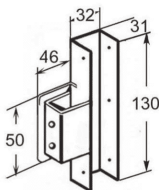
*Galv. side strike with angle for pillar (th.30mm)***Art. 30-00213**

(Kg.0,280)

Taschetta posteriore su angolare zinc. s/25

*Galv. rear strike with U profile for pillar(th25mm)***Art. 30-00214**

(Kg.0,333)

Taschetta posteriore su angolare zinc. s/30

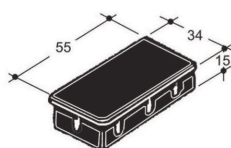
*Galv. rear strike with U profile for pillar(th30mm)***Art. 49-00020**

(Kg.0,009)

Tappo in plastica per montante anteriore L.56

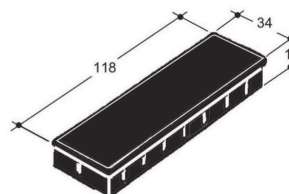
*Black PVC cap for front pillar L.56***Art. 49-00021**

(Kg.0,018)

Tappo in plastica per montante centrale e posteriore L.120

*Black PVC cap for rear and central pillar L.120*

**Testate zinc. per montanti a semplice apertura rovesciabili**

***Side board heads for aluminium for overturning pillars for simple opening***

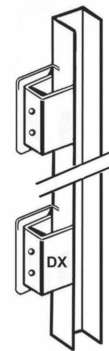
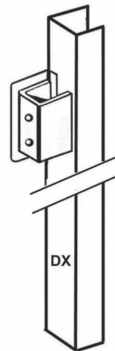

**25 mm.**

Descrizione testata S.25mm		Ali da Wings to	H.400	H.500	H.600	H.800
Description side board head Th.25mm.			Art.	Art.	Art.	Art.
Laterale Zinc. / Galv. lateral	Dx / R.	40	30-00220			
Laterale Zinc. / Galv. lateral	Sx / L.	40	30-00221			
Posteriore Zinc. / Galv. Rear	Dx / R.	40	30-00222			
Posteriore Zinc. / Galv. Rear	Sx / L.	40	30-00223			
Laterale Zinc. / Galv. lateral	Dx / R.	60	30-00252	30-00256	30-00260	30-00264
Laterale Zinc. / Galv. lateral	Sx / L.	60	30-00253	30-00257	30-00261	30-00265
Posteriore Zinc. / Galv. Rear	Dx / R.	60	30-00254	30-00258	30-00262	30-00266
Posteriore Zinc. / Galv. Rear	Sx / L.	60	30-00255	30-00259	30-00263	30-00267

Descrizione testata S.25mm		Ali da Wings to	H.900	H.1000	H.1100	H.1200
Description side board head Th.25mm.			Art.	Art.	Art.	Art.
Laterale Zinc. / Galv. lateral	Dx / R.	60	30-00268	30-00272	30-00276	30-00280
Laterale Zinc. / Galv. lateral	Sx / L.	60	30-00269	30-00273	30-00277	30-00281
Posteriore Zinc. / Galv. Rear	Dx / R.	60	30-00270	30-00274	30-00278	30-00282
Posteriore Zinc. / Galv. Rear	Sx / L.	60	30-00271	30-00275	30-00279	30-00283

**30 mm.**

Descrizione testata S.30mm		Ali da Wings to	H.400	H.500	H.600	H.800
Description side board head Th.30mm.			Art.	Art.	Art.	Art.
Laterale Zinc. / Galv. lateral	Dx / R.	40	30-00284			
Laterale Zinc. / Galv. lateral	Sx / L.	40	30-00285			
Posteriore Zinc. / Galv. Rear	Dx / R.	40	30-00286			
Posteriore Zinc. / Galv. Rear	Sx / L.	40	30-00287			
Laterale Zinc. / Galv. lateral	Dx / R.	60	30-00316	30-00320	30-00324	30-00328
Laterale Zinc. / Galv. lateral	Sx / L.	60	30-00317	30-00321	30-00325	30-00329
Posteriore Zinc. / Galv. Rear	Dx / R.	60	30-00318	30-00322	30-00326	30-00330
Posteriore Zinc. / Galv. Rear	Sx / L.	60	30-00319	30-00323	30-00327	30-00331

Descrizione testata S.30mm		Ali da Wings to	H.900	H.1000	H.1100	H.1200
Description side board head Th.30mm.			Art.	Art.	Art.	Art.
Laterale Zinc. / Galv. lateral	Dx / R.	60	30-00332	30-00336	30-00340	30-00344
Laterale Zinc. / Galv. lateral	Sx / L.	60	30-00333	30-00337	30-00341	30-00345
Posteriore Zinc. / Galv. Rear	Dx / R.	60	30-00334	30-00338	30-00342	30-00346
Posteriore Zinc. / Galv. Rear	Sx / L.	60	30-00335	30-00339	30-00343	30-00347

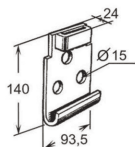
**Accessori INOX per Montanti a semplice apertura rovesciabili*****S.Steel accessories per Overturning pillars for simple opening*****Art.30-00551**

(Kg.0,767)

Piastra attacco montante normale INOX  
*Stainless steel sock for normal pillar*

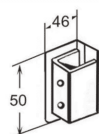
**Art. 30-00560**

(Kg.0,078)

Taschetta originale INOX  
*S.steel side strike for pillar*

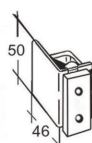
**Art. 30-00565**

(Kg.0,128)

Taschetta laterale registrabile INOX s/25  
*S.steel side strike for pillar (th.25mm) adjustable*

**Art. 30-00219**

(Kg.0,120)

Taschetta laterale modificata registrabile  
 per testate posteriori/arrotondate Inox  
*S.steel side strike for round sideboard heads (th. 25 mm) adjustable*

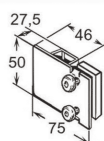
**Art. 30-00566**

(Kg.0,150)

Taschetta posteriore registrabile INOX s/25  
*S.steel rear strike for pillar (th25mm) adjustable*

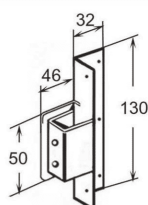
**Art. 30-00561**

(Kg.0,232)

Taschetta laterale su angolare INOX s/25  
*S.steel side strike with angle for pillar(th.25mm)*

**Art. 30-00562**

(Kg.0,242)

Taschetta laterale su angolare INOX s/30  
*S.steel side strike with angle for pillar(th.30mm)*

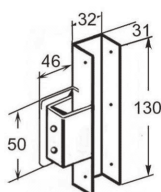
**Art. 30-00563**

(Kg.0,280)

Taschetta posteriore su angolare INOX s/25  
*S.steel rear strike with U profile for pillar(th25mm)*

**Art. 30-00564**

(Kg.0,333)

Taschetta posteriore su angolare INOX s/30  
*S.steel rear strike with U profile for pillar(th30mm)*

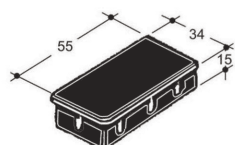
**Art. 49-00020**

(Kg.0,009)

Tappo in plastica per montante anteriore L.56  
*Black PVC cap for front pillar L.56*

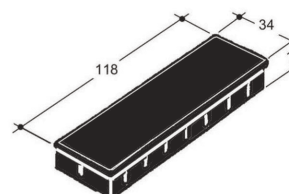
**Art. 49-00021**

(Kg.0,018)

Tappo in plastica per montante centrale e posteriore L.120  
*Black PVC cap for rear and central pillar L.120*

## Testate INOX per montanti a semplice apertura rovesciabili

### S.s. side board heads for aluminium for overturning for simple opening

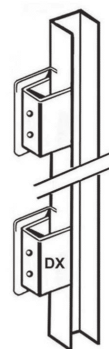
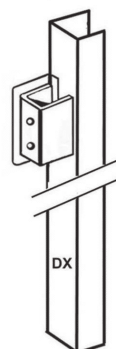

### 25 mm.

Descrizione testata S.25mm		Ali da Wings to	H.400	H.500	H.600	H.800
Description side board head Th.25mm.			Art.	Art.	Art.	Art.
Laterale Inox / S.steel lat.	Dx / R.	40	30-00580			
Laterale Inox / S.steel lat.	Sx / L.	40	30-00581			
Posteriore Inox / S.steel Rear	Dx / R.	40	30-00582			
Posteriore Inox / S.steel Rear	Sx / L.	40	30-00583			
Laterale Inox / S.steel lat.	Dx / R.	60	30-00656	30-00660	30-00664	30-00668
Laterale Inox / S.steel lat.	Sx / L.	60	30-00657	30-00661	30-00665	30-00669
Posteriore Inox / S.steel Rear	Dx / R.	60	30-00658	30-00662	30-00666	30-00670
Posteriore Inox / S.steel Rear	Sx / L.	60	30-00659	30-00663	30-00667	30-00671

Descrizione testata S.25mm		Ali da Wings to	H.900	H.1000	H.1100	H.1200
Description side board head Th.25mm.			Art.	Art.	Art.	Art.
Laterale Inox / S.steel lat.	Dx / R.	60	30-00672	30-00676	30-00680	30-00684
Laterale Inox / S.steel lat.	Sx / L.	60	30-00673	30-00677	30-00681	30-00685
Posteriore Inox / S.steel Rear	Dx / R.	60	30-00674	30-00678	30-00682	30-00686
Posteriore Inox / S.steel Rear	Sx / L.	60	30-00675	30-00679	30-00683	30-00687

### 30 mm.

Descrizione testata S.30mm		Ali da Wings to	H.400	H.500	H.600	H.800
Description side board head Th.30mm.			Art.	Art.	Art.	Art.
Laterale Inox / S.steel lat.	Dx / R.	40	30-00620			
Laterale Inox / S.steel lat.	Sx / L.	40	30-00621			
Posteriore Inox / S.steel Rear	Dx / R.	40	30-00622			
Posteriore Inox / S.steel Rear	Sx / L.	40	30-00623			
Laterale Inox / S.steel lat.	Dx / R.	60	30-00688	30-00692	30-00696	30-00700
Laterale Inox / S.steel lat.	Sx / L.	60	30-00689	30-00693	30-00697	30-00701
Posteriore Inox / S.steel Rear	Dx / R.	60	30-00690	30-00694	30-00698	30-00702
Posteriore Inox / S.steel Rear	Sx / L.	60	30-00691	30-00695	30-00699	30-00703

Descrizione testata S.30mm		Ali da Wings to	H.900	H.1000	H.1100	H.1200
Description side board head Th.30mm.			Art.	Art.	Art.	Art.
Laterale Inox / S.steel lat.	Dx / R.	60	30-00704	30-00708	30-00712	30-00716
Laterale Inox / S.steel lat.	Sx / L.	60	30-00705	30-00709	30-00713	30-00717
Posteriore Inox / S.steel Rear	Dx / R.	60	30-00706	30-00710	30-00714	30-00718
Posteriore Inox / S.steel Rear	Sx / L.	60	30-00707	30-00711	30-00715	30-00719

#### A richiesta / On demand

Versione inox fioretato

S.s.anti-reflex treatment version

= aggiungere a fine articolo la F (es: 30-00..... /F)

= add at the end of Article F (es: 30-00..... /F)

## Montanti per apertura universale smussati con 1 - 2 leve

### Removable double pillars for tippers with 1 - 2 levers

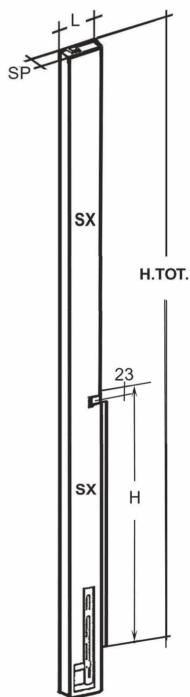

Anteriore alto  
High Front

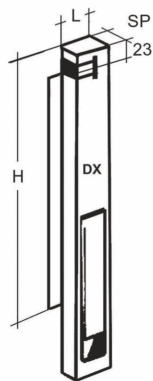

Anteriore  
Front

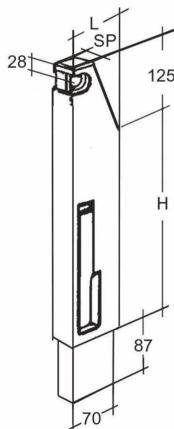

Posteriore  
smussato  
(1 leva)

Rear  
double pillar  
(1 lever)

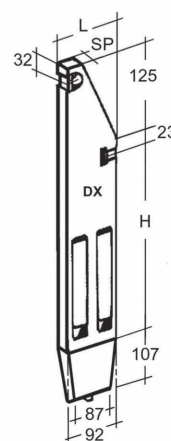

Post.sfilabile  
smussato  
(2 leve)

Rear removable  
double pillar  
(2 levers)

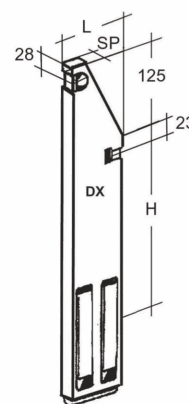

Post.rovesciabile  
smussato  
(2 leve)

Rear overturning  
double pillar  
(2 levers)

Descrizione montante Description pillar	Sp. Th.	leve lever	L		H. 400	H. 500
					Art.	Art.
Ant. H.1600 / Front H.1600	33		60	Dx / R.	30-00813	30-00828
Ant. H.1600 / Front H.1600	33		60	Sx / L.	30-00814	30-00829
Anteriore / Front	33		56	Dx / R.	30-00815	30-00830
Anteriore / Front	33		56	Sx / L.	30-00816	30-00831
Anteriore / Front	33		80	Dx / R.	30-00822	.....
Anteriore / Front	33		80	Sx / L.	30-00823	.....
Post.smussato / Rear double	36	1	85	Dx / R.	30-00800	30-00802
Post.smussato / Rear double	36	1	85	Sx / L.	30-00801	30-00803
Post.smus.sfilab./ Rear removable double	33	2	100	Dx / R.	30-00817	30-00832
Post.smus.sfilab./ Rear removable double	33	2	100	Sx / L.	30-00818	30-00833
Post.smus.rov. / Rear overturning double	33	2	100	Dx / R.	30-00819	30-00834
Post.smus.rov. / Rear overturning double	33	2	100	Sx / L.	30-00820	30-00835

## Accessori per montanti smussati per apertura universale e sfilabili

### Accessories for removable double pillars for tippers

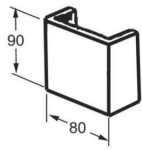

**Art. 30-00804** (Kg.0,474)  
 Sede per montante (ricambio) art. 30-00800 / 801 / 802 / 803  
 Sock (female part) (spare part) for art. 30-00800 / 801 / 802 / 803

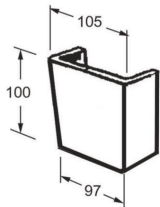

**Art. 30-00821** (Kg.0,461)  
 Sede per montante post.smuss. sfilabile  
 art. 30-00817 / 818 / 832 / 833 (ricambio)  
 Sock (female part) for removable double pillar  
 for art. 30-00817 / 818 / 832 / 833 (spare part)

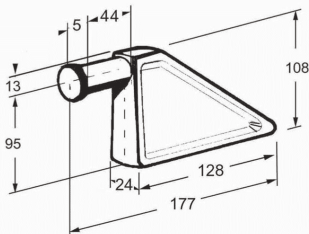

**Art. 32-00136** (Kg.1,208)  
 Bandierina perno D.20 / Low column pin D.20

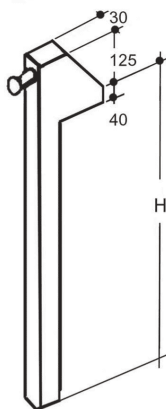

**Art. 30-00805** (Kg.1,200)  
 Test.speciale zinc.c/perno D.20  
 S/25 - ali 40 - H.400 - DX/SX  
 Galv.special side board head with pin D.20  
 Th/25 - wings 40mm - H=400 - R/L

**Art. 30-00806** (Kg.1,350)  
 Test.speciale zinc. c/perno D.20  
 S/25 - ali 40 - H.500 - DX/SX  
 Galv.special side board head with pin D.20  
 Th/25 - wings 40mm -H=500 - R/L

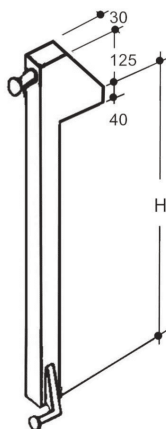

**Art. 30-00807** (Kg.1,400)  
 Test.speciale zinc.c/perno D.20 e cerniera  
 S/25 - ali 40 - H.400 - DX/SX  
 Galv.special side board head with pin D.20  
 and hinge - Th/25 - wings 40mm - H=400 - R/L

**Art. 30-00808** (Kg.1,500)  
 Test.speciale zinc. c/perno D.20 e cerniera  
 S/25 - ali 40 - H.500 - DX/SX  
 Galv.side board head with pin D.20  
 and hinge - Th/25 - wings 40mm -H=500 - R/L

Dimensioni montanti per apertura universale rovesciabili SP.33mm.

*Overturning pillars Th.33mm. for tippers*

Anteriore / Front	L = 56 (a richiesta / on demand)
Anteriore / Front	L = 85
Anteriore / Front (wide)	L = 120
Centrale / Central	L = 120
Posteriore / Rear	L = 120

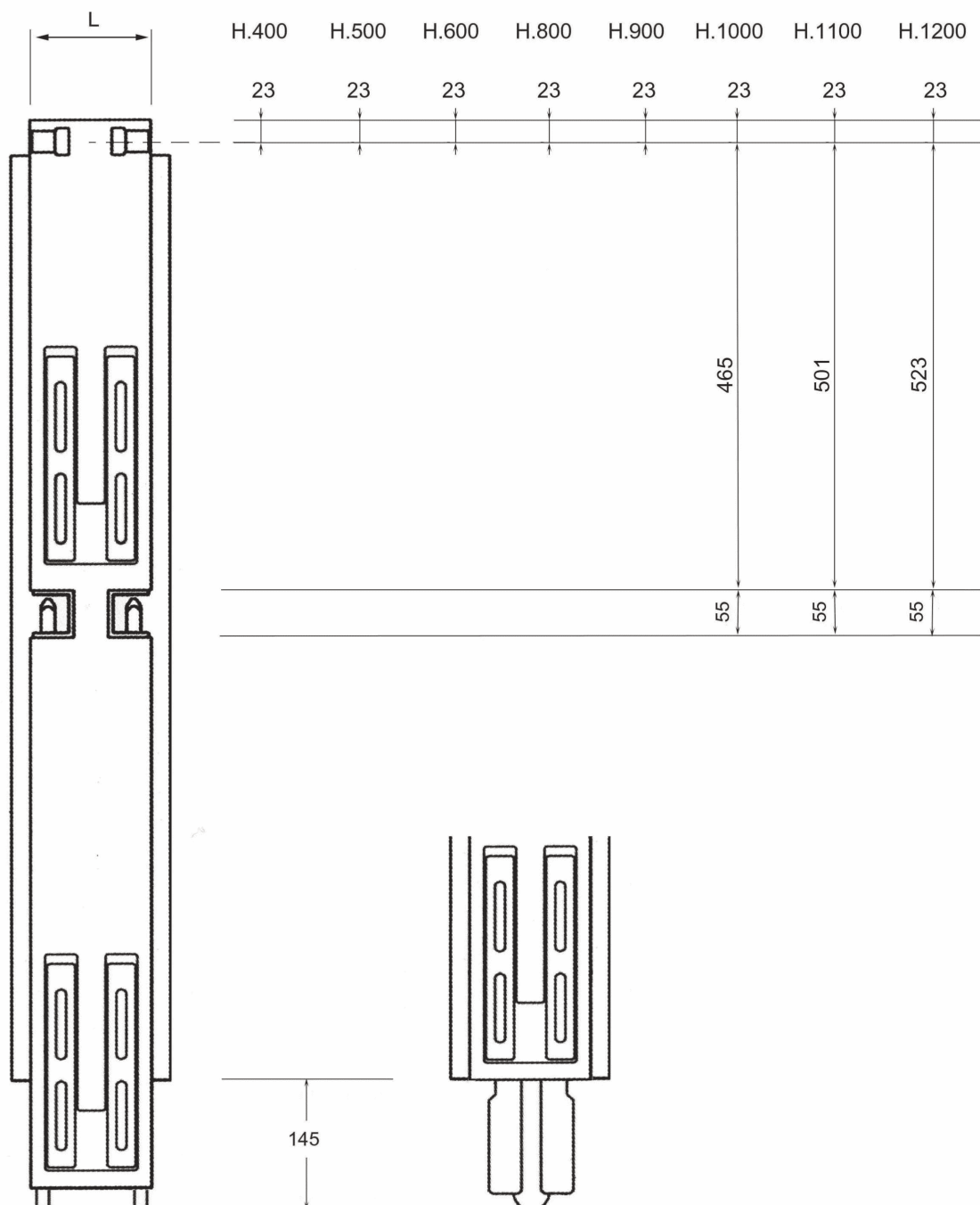

Montanti per apertura universale rovesciabili SP.33mm.

Overturning pillars Th.33mm. for tippers

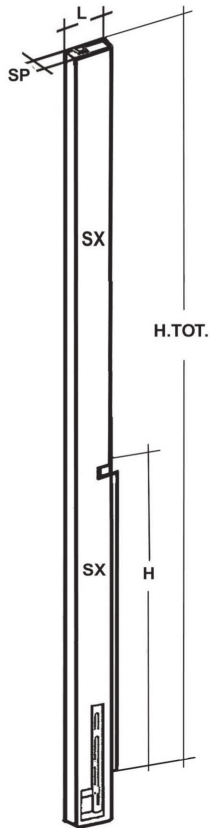

**Anteriore alto**  
*High Front*

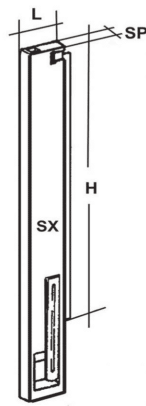

**Anteriore stretto**  
*Front (tight)*

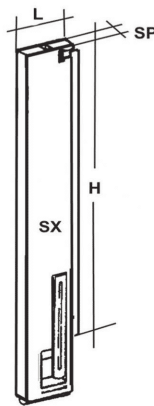

**Anteriore largo**  
*Front (wide)*

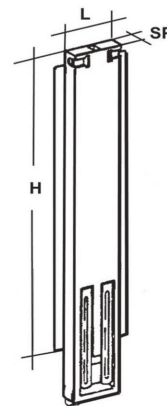

**Centrale**  
*Central*

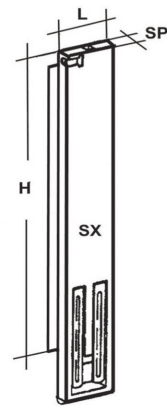

**Posteriore**  
*Rear*

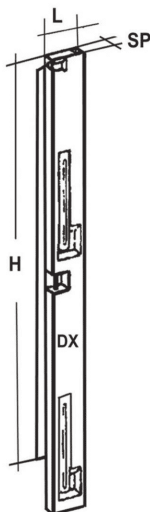

**Anteriore stretto**  
*Front (tight)*

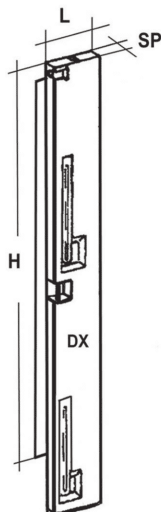

**Anteriore largo**  
*Front (wide)*

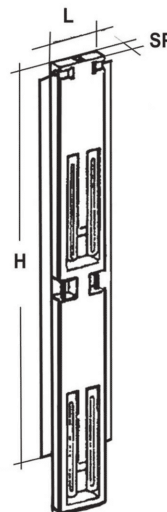

**Centrale**  
*Central*

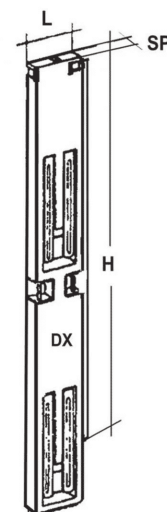

**Posteriore**  
*Rear*

**Montanti per apertura universale rovesciabili SP.33mm.*****Overturning pillars Th.33mm. for tippers***

Descrizione montante <i>Description pillar</i>	L. W.		H.300		
			Art.		
Anteriore / <i>Front</i> - H.tot.1600	60	Dx / R.	30-00851/L		
Anteriore / <i>Front</i> - H.tot.1600	60	Sx / L.	30-00852/L		
Anteriore / <i>Front</i>	56	Dx / R.	30-00851		
Anteriore / <i>Front</i>	56	Sx / L.	30-00852		
Anteriore / <i>Front</i>	100	Dx / R.	30-00853		
Anteriore / <i>Front</i>	100	Sx / L.	30-00854		
Centrale / <i>Central</i>	100		30-00855		
Posteriore / <i>Rear</i>	100	Dx / R.	30-00856		
Posteriore / <i>Rear</i>	100	Sx / L.	30-00857		

Descrizione montante <i>Description pillar</i>	L. W.		H.400	H.500	H.600
			Art.	Art.	Art.
Anteriore / <i>Front</i> - H.tot.1600	85	Dx / R.	30-00860/L		
Anteriore / <i>Front</i> - H.tot.1600	85	Sx / L.	30-00861/L		
Anteriore / <i>Front</i> - H.tot.1800	85	Dx / R.		30-00867/L	
Anteriore / <i>Front</i> - H.tot.1800	85	Sx / L.		30-00868/L	
Ant. Sganciabile / <i>Front detachable</i>	56	Dx / R.	30-00860/SG	30-00867/SG	30-00874/SG
Ant. Sganciabile / <i>Front detachable</i>	56	Sx / L.	30-00861/SG	30-00868/SG	30-00875/SG
Anteriore / <i>Front</i>	85	Dx / R.	30-00860	30-00867	30-00874
Anteriore / <i>Front</i>	85	Sx / L.	30-00861	30-00868	30-00875
Anteriore / <i>Front</i>	120	Dx / R.	30-00862	30-00869	30-00876
Anteriore / <i>Front</i>	120	Sx / L.	30-00863	30-00870	30-00877
Centrale / <i>Central</i>	120		30-00864	30-00871	30-00878
Posteriore / <i>Rear</i>	120	Dx / R.	30-00865	30-00872	30-00879
Posteriore / <i>Rear</i>	120	Sx / L.	30-00866	30-00873	30-00880

Descrizione montante <i>Description pillar</i>	L. W.		H.700	H.800	H.900
			Art.	Art.	Art.
Ant. Sganciabile / <i>Front detachable</i>	56	Dx / R.	30-00890/SG	30-00897/SG	30-00904/SG
Ant. Sganciabile / <i>Front detachable</i>	56	Sx / L.	30-00891/SG	30-00898/SG	30-00905/SG
Anteriore / <i>Front</i>	85	Dx / R.	30-00890	30-00897	30-00904
Anteriore / <i>Front</i>	85	Sx / L.	30-00891	30-00898	30-00905
Anteriore / <i>Front</i>	120	Dx / R.	30-00892	30-00899	30-00906
Anteriore / <i>Front</i>	120	Sx / L.	30-00893	30-00900	30-00907
Centrale / <i>Central</i>	120		30-00894	30-00901	30-00908
Posteriore / <i>Rear</i>	120	Dx / R.	30-00895	30-00902	30-00909
Posteriore / <i>Rear</i>	120	Sx / L.	30-00896	30-00903	30-00910

Descrizione montante <i>Description pillar</i>	L. W.		H.1000	H.1100	H.1200
			Art.	Art.	Art.
Ant. Sganciabile / <i>Front detachable</i>	56	Dx / R.	30-00911/SG	30-00918/SG	30-00925/SG
Ant. Sganciabile / <i>Front detachable</i>	56	Sx / L.	30-00912/SG	30-00919/SG	30-00926/SG
Anteriore / <i>Front</i>	85	Dx / R.	30-00911	30-00918	30-00925
Anteriore / <i>Front</i>	85	Sx / L.	30-00912	30-00919	30-00926
Anteriore / <i>Front</i>	120	Dx / R.	30-00913	30-00920	30-00927
Anteriore / <i>Front</i>	120	Sx / L.	30-00914	30-00921	30-00928
Centrale / <i>Central</i>	120		30-00915	30-00922	30-00929
Posteriore / <i>Rear</i>	120	Dx / R.	30-00916	30-00923	30-00930
Posteriore / <i>Rear</i>	120	Sx / L.	30-00917	30-00924	30-00931

## Montanti rovesciabili Sp.33

Posteriori apertura universale e Laterali cassone fisso

Overturning rear pillars Th.33mm.

for tippers and overturning central pillars Th.33mm.for fixed load body

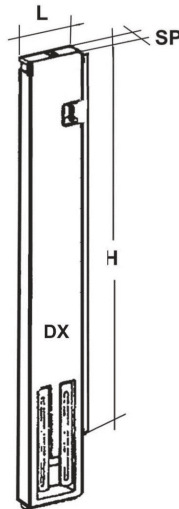

Posteriore L. 120 Laterale C. F. - Posteriore ribaltabile  
Rear for tipper and central for fixed load body L. 120

	H.600	H.700	H.800	H.900	H.1000	H.1100	H.1200
	Art.	Art.	Art.	Art.	Art.	Art.	Art.
Dx / R.	30-00935	30-00937	30-00940	30-00942	30-00945	30-00947	30-00949
Sx / L.	30-00936	30-00938	30-00941	30-00943	30-00946	30-00948	30-00950

**Montanti per apertura universale rovesciabili SP.33mm. (parzialmente inox)*****Overturning pillars Th.33mm for tippers (partially s.s.)***

Descrizione montante <i>Description pillar</i>	L. W.		H.400	H.500	H.600
			Art.	Art.	Art.
Anteriore / <i>Front</i> - H.tot.1600	85	Dx / R.	30-01280/L		
Anteriore / <i>Front</i> - H.tot.1600	85	Sx / L.	30-01281/L		
Anteriore / <i>Front</i> - H.tot.1800	85	Dx / R.		30-01288/L	
Anteriore / <i>Front</i> - H.tot.1800	85	Sx / L.		30-01289/L	
Ant. Sganciabile / <i>Front detachable</i>	56	Dx / R.	30-01280/SG	30-01288/SG	30-01295/SG
Ant. Sganciabile / <i>Front detachable</i>	56	Sx / L.	30-01281/SG	30-01289/SG	30-01296/SG
Anteriore / <i>Front</i>	85	Dx / R.	30-01280	30-01288	30-01295
Anteriore / <i>Front</i>	85	Sx / L.	30-01281	30-01289	30-01296
Anteriore / <i>Front</i>	120	Dx / R.	30-01282	30-01290	30-01297
Anteriore / <i>Front</i>	120	Sx / L.	30-01283	30-01291	30-01298
Centrale / <i>Central</i>	120		30-01284	30-01292	30-01299
Posteriore / <i>Rear</i>	120	Dx / R.	30-01286	30-01293	30-01300
Posteriore / <i>Rear</i>	120	Sx / L.	30-01287	30-01294	30-01301

Descrizione montante <i>Description pillar</i>	L. W.		H.700	H.800	H.900
			Art.	Art.	Art.
Ant. Sganciabile / <i>Front detachable</i>	56	Dx / R.	30-01302/SG	30-01309/SG	30-01318/SG
Ant. Sganciabile / <i>Front detachable</i>	56	Sx / L.	30-01303/SG	30-01310/SG	30-01319/SG
Anteriore / <i>Front</i>	85	Dx / R.	30-01302	30-01309	30-01318
Anteriore / <i>Front</i>	85	Sx / L.	30-01303	30-01310	30-01319
Anteriore / <i>Front</i>	120	Dx / R.	30-01304	30-01311	30-01320
Anteriore / <i>Front</i>	120	Sx / L.	30-01305	30-01312	30-01321
Centrale / <i>Central</i>	120		30-01306	30-01313	30-01322
Posteriore / <i>Rear</i>	120	Dx / R.	30-01307	30-01314	30-01323
Posteriore / <i>Rear</i>	120	Sx / L.	30-01308	30-01317	30-01324

Descrizione montante <i>Description pillar</i>	L. W.		H.1000	H.1100	H.1200
			Art.	Art.	Art.
Ant. Sganciabile / <i>Front detachable</i>	56	Dx / R.	30-01325/SG	30-01332/SG	30-01339/SG
Ant. Sganciabile / <i>Front detachable</i>	56	Sx / L.	30-01326/SG	30-01333/SG	30-01340/SG
Anteriore / <i>Front</i>	85	Dx / R.	30-01325	30-01332	30-01339
Anteriore / <i>Front</i>	85	Sx / L.	30-01326	30-01333	30-01340
Anteriore / <i>Front</i>	120	Dx / R.	30-01327	30-01334	30-01341
Anteriore / <i>Front</i>	120	Sx / L.	30-01328	30-01335	30-01342
Centrale / <i>Central</i>	120		30-01329	30-01336	30-01343
Posteriore / <i>Rear</i>	120	Dx / R.	30-01330	30-01337	30-01344
Posteriore / <i>Rear</i>	120	Sx / L.	30-01331	30-01338	30-01345

**A richiesta / On demand**

Versione parzialmente inox fiorettato = aggiungere a fine articolo la F (es: 30-01..... /F)

Partially S.s. anti-reflex treatment version = add at the end of Article F (es: 30-01..... /F)

**Montanti Total. /inox per apertura universale rovesciabili Sp.33**

***Overturning pillars Th.33mm for tippers (totally stainless steel)***

Descrizione montante <i>Description pillar</i>	L. W.		H.400	H.500	H.600
			Art.	Art.	Art.
Anteriore / Front - H.tot.1600	85	Dx / R.	30-01280/TI/L		
Anteriore / Front - H.tot.1600	85	Sx / L.	30-01281/TI/L		
Anteriore / Front - H.tot.1800	85	Dx / R.		30-01288/TI/L	
Anteriore / Front - H.tot.1800	85	Sx / L.		30-01289/TI/L	
Ant. Sganciabile / Front detachable	56	Dx / R.	30-01280/TI/SG	30-01288/TI/SG	30-01295/TI/SG
Ant. Sganciabile / Front detachable	56	Sx / L.	30-01281/TI/SG	30-01289/TI/SG	30-01296/TI/SG
Anteriore / Front	85	Dx / R.	30-01280/TI	30-01288/TI	30-01295/TI
Anteriore / Front	85	Sx / L.	30-01281/TI	30-01289/TI	30-01296/TI
Anteriore / Front	120	Dx / R.	30-01282/TI	30-01290/TI	30-01297/TI
Anteriore / Front	120	Sx / L.	30-01283/TI	30-01291/TI	30-01298/TI
Centrale / Central	120		30-01284/TI	30-01292/TI	30-01299/TI
Posteriore / Rear	120	Dx / R.	30-01286/TI	30-01293/TI	30-01300/TI
Posteriore / Rear	120	Sx / L.	30-01287/TI	30-01294/TI	30-01301/TI

Descrizione montante <i>Description pillar</i>	L. W.		H.700	H.800	H.900
			Art.	Art.	Art.
Ant. Sganciabile / Front detachable	56	Dx / R.	30-01302/TI/SG	30-01309/TI/SG	30-01318/TI/SG
Ant. Sganciabile / Front detachable	56	Sx / L.	30-01303/TI/SG	30-01310/TI/SG	30-01319/TI/SG
Anteriore / Front	85	Dx / R.	30-01302/TI	30-01309/TI	30-01318/TI
Anteriore / Front	85	Sx / L.	30-01303/TI	30-01310/TI	30-01319/TI
Anteriore / Front	120	Dx / R.	30-01304/TI	30-01311/TI	30-01320/TI
Anteriore / Front	120	Sx / L.	30-01305/TI	30-01312/TI	30-01321/TI
Centrale / Central	120		30-01306/TI	30-01313/TI	30-01322/TI
Posteriore / Rear	120	Dx / R.	30-01307/TI	30-01314/TI	30-01323/TI
Posteriore / Rear	120	Sx / L.	30-01308/TI	30-01317/TI	30-01324/TI

Descrizione montante <i>Description pillar</i>	L. W.		H.1000	H.1100	H.1200
			Art.	Art.	Art.
Ant. Sganciabile / Front detachable	56	Dx / R.	30-01325/TI/SG	30-01332/TI/SG	30-01339/TI/SG
Ant. Sganciabile / Front detachable	56	Sx / L.	30-01326/TI/SG	30-01333/TI/SG	30-01340/TI/SG
Anteriore / Front	85	Dx / R.	30-01325/TI	30-01332/TI	30-01339/TI
Anteriore / Front	85	Sx / L.	30-01326/TI	30-01333/TI	30-01340/TI
Anteriore / Front	120	Dx / R.	30-01327/TI	30-01334/TI	30-01341/TI
Anteriore / Front	120	Sx / L.	30-01328/TI	30-01335/TI	30-01342/TI
Centrale / Central	120		30-01329/TI	30-01336/TI	30-01343/TI
Posteriore / Rear	120	Dx / R.	30-01330/TI	30-01337/TI	30-01344/TI
Posteriore / Rear	120	Sx / L.	30-01331/TI	30-01338/TI	30-01345/TI

**A richiesta / On demand**

**Versione Totalmente inox fiorettato = aggiungere a fine articolo la F (es: 30-01...../TI/F)**

**Totally S.s. anti-reflex treatment version = add at the end of Article F (es: 30-01...../TI/F)**

Montanti per apertura universale sfilabili Sp.33

*Removable pillars Th.33mm. for tippers*

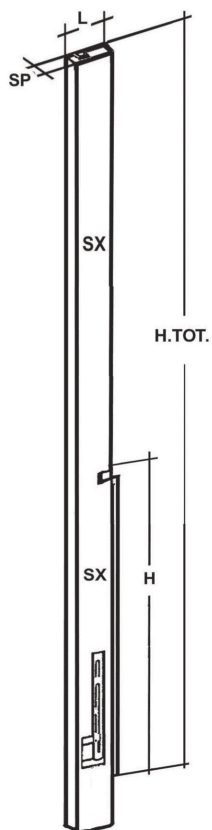

Anteriore alto  
*High Front*

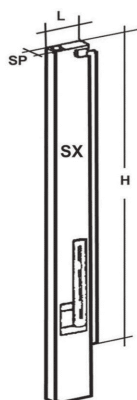

Anteriore stretto  
*Front (tight)*

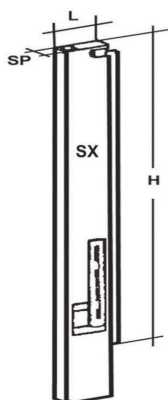

Anteriore largo  
*Front (wide)*

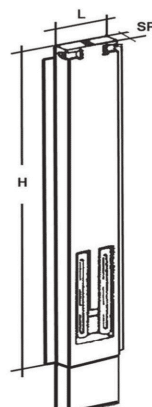

Centrale  
*Central*

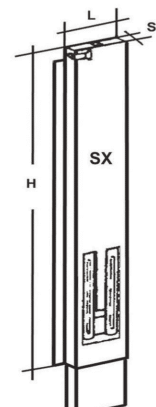

Posteriore  
*Rear*

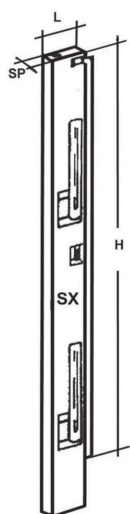

Anteriore stretto  
*Front (tight)*

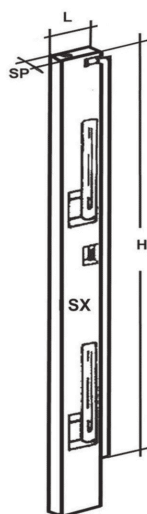

Anteriore largo  
*Front (wide)*

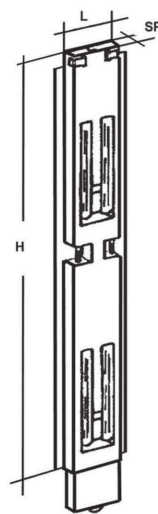

Centrale  
*Central*

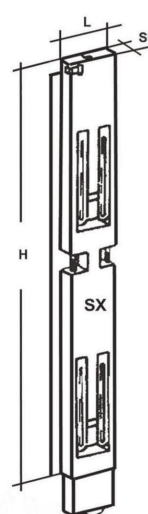

Posteriore  
*Rear*

**Montanti per apertura universale sfilabili Sp.33**

***Removable pillars Th.33mm. for tippers***

Descrizione montante <i>Description pillar</i>	L. W.		H.400	H.500	H.600
			Art.	Art.	Art.
Anteriore / Front - H.tot.1600	85	Dx / R.	30-01000/L		
Anteriore / Front - H.tot.1600	85	Sx / L.	30-01002/L		
Anteriore / Front - H.tot.1800	85	Dx / R.		30-01008/L	
Anteriore / Front - H.tot.1800	85	Sx / L.		30-01009/L	
Anteriore / Front	85	Dx / R.	30-01000	30-01008	30-01015
Anteriore / Front	85	Sx / L.	30-01002	30-01009	30-01016
Anteriore / Front	120	Dx / R.	30-01003	30-01010	30-01017
Anteriore / Front	120	Sx / L.	30-01004	30-01011	30-01018
Ant.con innesto / Front with male part	120	Dx / R.			30-01017/S
Ant.con innesto / Front with male part	120	Sx / L.			30-01018/S
Centrale / Central	120		30-01005	30-01012	30-01019
Posteriore / Rear	120	Dx / R.	30-01006	30-01013	30-01020
Posteriore / Rear	120	Sx / L.	30-01007	30-01014	30-01021

Descrizione montante <i>Description pillar</i>	L. W.		H.700	H.800	H.900
			Art.	Art.	Art.
Anteriore / Front	85	Dx / R.	30-01022	30-01029	30-01036
Anteriore / Front	85	Sx / L.	30-01023	30-01030	30-01037
Anteriore / Front	120	Dx / R.	30-01024	30-01031	30-01038
Anteriore / Front	120	Sx / L.	30-01025	30-01032	30-01039
Ant.con innesto / Front with male part	120	Dx / R.	30-01024/S	30-01031/S	
Ant.con innesto / Front with male part	120	Sx / L.	30-01025/S	30-01032/S	
Centrale / Central	120		30-01026	30-01033	30-01040
Posteriore / Rear	120	Dx / R.	30-01027	30-01034	30-01041
Posteriore / Rear	120	Sx / L.	30-01028	30-01035	30-01042

Descrizione montante <i>Description pillar</i>	L. W.		H.1000	H.1100	H.1200
			Art.	Art.	Art.
Anteriore / Front	85	Dx / R.	30-01043	30-01050	30-01057
Anteriore / Front	85	Sx / L.	30-01044	30-01051	30-01058
Anteriore / Front	120	Dx / R.	30-01045	30-01052	30-01059
Anteriore / Front	120	Sx / L.	30-01046	30-01053	30-01060
Centrale / Central	120		30-01047	30-01054	30-01061
Posteriore / Rear	120	Dx / R.	30-01048	30-01055	30-01062
Posteriore / Rear	120	Sx / L.	30-01049	30-01056	30-01063

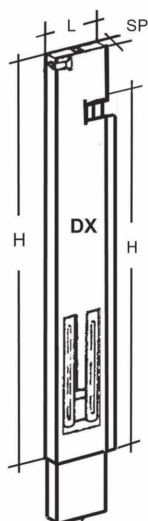
**Montanti a doppia altezza per apertura universale sfilabili Sp.33mm.****Removable double pillars Th. 33mm.for tippers**

Art.	Descrizione montante / Description pillar
30-01006/H	Posteriore Dx - Laterale H.400 - Posteriore H.500 <i>Removable double rear right pillar for tipper side H.400 rear H.500</i>
30-01007/H	Posteriore Sx - Laterale H.400 - Posteriore H.500 <i>Removable double rear left pillar for tipper side H.400 rear H.500</i>
30-01013/ H	Posteriore Dx - Laterale H.500 - Posteriore H.600 <i>Removable double rear right pillar for tipper side H.500 rear H.600</i>
30-01014/ H	Posteriore Sx - Laterale H.500 - Posteriore H.600 <i>Removable double rear left pillar for tipper side H.500 rear H.600</i>
30-01020/ H	Posteriore Dx - Laterale H.600 - Posteriore H.700 <i>Removable double rear right pillar for tipper side H.600 rear H.700</i>
30-01021/ H	Posteriore Sx - Laterale H.600 - Posteriore H.700 <i>Removable double rear left pillar for tipper side H.600 rear H.700</i>
30-01027/ H	Posteriore Dx - Laterale H.700 - Posteriore H.800 <i>Removable double rear right pillar for tipper side H.700 rear H.800</i>
30-01028/ H	Posteriore Sx - Laterale H.700 - Posteriore H.800 <i>Removable double rear left pillar for tipper side H.700 rear H.800</i>

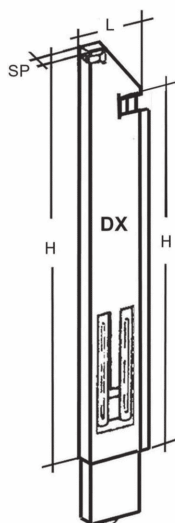
**Mont.doppia H. Sp.33 (perno post.Ø20) apert.universale sfilabili e smussati****Removable double pillars Th.33mm.for tippers (pin Ø20)**

Art.	Descrizione montante / Description pillar
30-01006/HS	Posteriore Dx - Laterale H.400 - Posteriore H.500 <i>Removable double rear right pillar for tipper side H.400 rear H.500</i>
30-01007/HS	Posteriore Sx - Laterale H.400 - Posteriore H.500 <i>Removable double rear left pillar for tipper side H.400 rear H.500</i>
30-01013/ HS	Posteriore Dx - Laterale H.500 - Posteriore H.600 <i>Removable double rear right pillar for tipper side H.500 rear H.600</i>
30-01014/ HS	Posteriore Sx - Laterale H.500 - Posteriore H.600 <i>Removable double rear left pillar for tipper side H.500 rear H.600</i>
30-01020/ HS	Posteriore Dx - Laterale H.600 - Posteriore H.700 <i>Removable double rear right pillar for tipper side H.600 rear H.700</i>
30-01021/ HS	Posteriore Sx - Laterale H.600 - Posteriore H.700 <i>Removable double rear left pillar for tipper side H.600 rear H.700</i>
30-01027/ HS	Posteriore Dx - Laterale H.700 - Posteriore H.800 <i>Removable double rear right pillar for tipper side H.700 rear H.800</i>
30-01028/ HS	Posteriore Sx - Laterale H.700 - Posteriore H.800 <i>Removable double rear left pillar for tipper side H.700 rear H.800</i>

## Montanti per apertura universale sfilabili Sp.33 (parzialmente inox)

### Removable pillars Th.33mm. for tippers (partially s.s.)

Descrizione montante <i>Description pillar</i>	L. W.		H.400	H.500	H.600
			Art.	Art.	Art.
Anteriore / Front - H.tot.1600	85	Dx / R.	30-01390/L		
Anteriore / Front - H.tot.1600	85	Sx / L.	30-01391/L		
Anteriore / Front - H.tot.1800	85	Dx / R.		30-01397/L	
Anteriore / Front - H.tot.1800	85	Sx / L.		30-01398/L	
Anteriore / Front	85	Dx / R.	30-01390	30-01397	30-01404
Anteriore / Front	85	Sx / L.	30-01391	30-01398	30-01405
Anteriore / Front	120	Dx / R.	30-01392	30-01399	30-01406
Anteriore / Front	120	Sx / L.	30-01393	30-01400	30-01407
Centrale / Central	120		30-01394	30-01401	30-01408
Posteriore / Rear	120	Dx / R.	30-01395	30-01402	30-01409
Posteriore / Rear	120	Sx / L.	30-01396	30-01403	30-01410

Descrizione montante <i>Description pillar</i>	L. W.		H.700	H.800	H.900
			Art.	Art.	Art.
Anteriore / Front	85	Dx / R.	30-01411	30-01418	30-01425
Anteriore / Front	85	Sx / L.	30-01412	30-01419	30-01426
Anteriore / Front	120	Dx / R.	30-01413	30-01420	30-01427
Anteriore / Front	120	Sx / L.	30-01414	30-01421	30-01428
Centrale / Central	120		30-01415	30-01422	30-01429
Posteriore / Rear	120	Dx / R.	30-01416	30-01423	30-01430
Posteriore / Rear	120	Sx / L.	30-01417	30-01424	30-01431

Descrizione montante <i>Description pillar</i>	L. W.		H.1000	H.1100	H.1200
			Art.	Art.	Art.
Anteriore / Front	85	Dx / R.	30-01432	30-01439	30-01446
Anteriore / Front	85	Sx / L.	30-01433	30-01440	30-01447
Anteriore / Front	120	Dx / R.	30-01434	30-01441	30-01448
Anteriore / Front	120	Sx / L.	30-01435	30-01442	30-01449
Centrale / Central	120		30-01436	30-01443	30-01450
Posteriore / Rear	120	Dx / R.	30-01437	30-01444	30-01451
Posteriore / Rear	120	Sx / L.	30-01438	30-01445	30-01452

#### A richiesta / On demand

Versione parzialmente inox fiorettato = aggiungere a fine articolo la F (es: 30-01..... /F)

Partially S.s. anti-reflex treatment version = add at the end of Article F (es: 30-01..... /F)

## Montanti Tot./ inox per apertura universale sfilabili Sp.33

*Removable pillars Th.33mm. for tippers (Tot./stainless steel)*

Descrizione montante <i>Description pillar</i>	L. W.		H.400	H.500	H.600
			Art.	Art.	Art.
Anteriore / <i>Front</i> - H.tot. 1600	85	Dx / R.	30-01390/TI/L		
Anteriore / <i>Front</i> - H.tot. 1600	85	Sx / L.	30-01391/TI/L		
Anteriore / <i>Front</i> - H.tot. 1800	85	Dx / R.		30-01397/TI/L	
Anteriore / <i>Front</i> - H.tot. 1800	85	Sx / L.		30-01398/TI/L	
Anteriore / <i>Front</i>	85	Dx / R.	30-01390/TI	30-01397/TI	30-01404/TI
Anteriore / <i>Front</i>	85	Sx / L.	30-01391/TI	30-01398/TI	30-01405/TI
Anteriore / <i>Front</i>	120	Dx / R.	30-01392/TI	30-01399/TI	30-01406/TI
Anteriore / <i>Front</i>	120	Sx / L.	30-01393/TI	30-01400/TI	30-01407/TI
Centrale / <i>Central</i>	120		30-01394/TI	30-01401/TI	30-01408/TI
Posteriore / <i>Rear</i>	120	Dx / R.	30-01395/TI	30-01402/TI	30-01409/TI
Posteriore / <i>Rear</i>	120	Sx / L.	30-01396/TI	30-01403/TI	30-01410/TI

Descrizione montante <i>Description pillar</i>	L. W.		H.700	H.800	H.900
			Art.	Art.	Art.
Anteriore / <i>Front</i>	85	Dx / R.	30-01411/TI	30-01418/TI	30-01425/TI
Anteriore / <i>Front</i>	85	Sx / L.	30-01412/TI	30-01419/TI	30-01426/TI
Anteriore / <i>Front</i>	120	Dx / R.	30-01413/TI	30-01420/TI	30-01427/TI
Anteriore / <i>Front</i>	120	Sx / L.	30-01414/TI	30-01421/TI	30-01428/TI
Centrale / <i>Central</i>	120		30-01415/TI	30-01422/TI	30-01429/TI
Posteriore / <i>Rear</i>	120	Dx / R.	30-01416/TI	30-01423/TI	30-01430/TI
Posteriore / <i>Rear</i>	120	Sx / L.	30-01417/TI	30-01424/TI	30-01431/TI

Descrizione montante <i>Description pillar</i>	L. W.		H.1000	H.1100	H.1200
			Art.	Art.	Art.
Anteriore / <i>Front</i>	85	Dx / R.	30-01432/TI	30-01439/TI	30-01446/TI
Anteriore / <i>Front</i>	85	Sx / L.	30-01433/TI	30-01440/TI	30-01447/TI
Anteriore / <i>Front</i>	120	Dx / R.	30-01434/TI	30-01441/TI	30-01448/TI
Anteriore / <i>Front</i>	120	Sx / L.	30-01435/TI	30-01442/TI	30-01449/TI
Centrale / <i>Central</i>	120		30-01436/TI	30-01443/TI	30-01450/TI
Posteriore / <i>Rear</i>	120	Dx / R.	30-01437/TI	30-01444/TI	30-01451/TI
Posteriore / <i>Rear</i>	120	Sx / L.	30-01438/TI	30-01445/TI	30-01452/TI

**A richiesta / On demand**

Versione Totalmente inox fioretato = aggiungere a fine articolo la F (es: 30-01...../TI/F)

Totally S.s. anti-reflex treatment version = add at the end of Article F (es: 30-01...../TI/F)

**Accessori per montanti per apertura universale**

***Accessories for pillars for tippers***

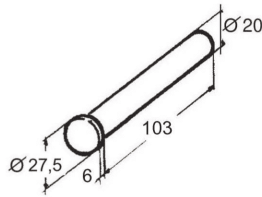

**Art. 30-01270**  
Perno per ribaltabile Ø 20 testa Ø 27,5 L=103  
*Pin for head L=103*

(Kg.0,274)

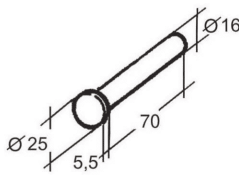

**Art. 30-01272**  
Perno per testata ribaltabile Ø 16 testa Ø 25 L=70  
*Pin for head L=70*

(Kg.0,130)

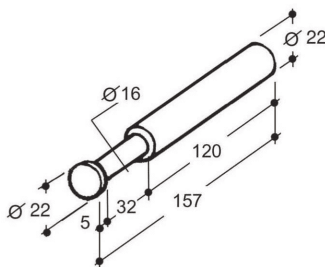

**Art. 30-01273**  
Perno disassato per testata ribaltabile Ø 22-Ø 16 testa Ø 22 L=157  
*Eccentric pin for head L=157*

(Kg.0,411)

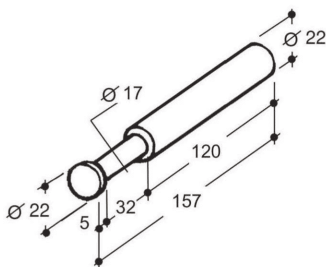

**Art. 30-01276**  
Perno per testata ribaltabile Ø 22-Ø 17 testa Ø 22 L=157  
*Pin for head L=157*

(Kg.0,425)

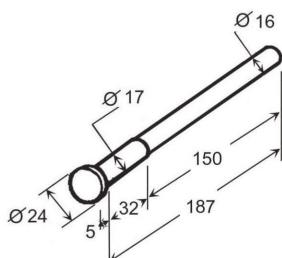

**Art. 30-01277**  
Perno per testata ribaltabile Ø 16-Ø 17 testa Ø 24 L=187  
*Pin for head L=187*

(Kg.0,310)

## Testate zincate per montanti apertura universale

### *Galv.side board heads for aluminium for pillars for tippers*

#### 25 mm.



Descrizione testata S.25mm <i>Description side board head Th.25mm.</i>		Ali da Wings to	H.400 Art.	H.500 Art.	H.600 Art.
Ribaltabile / Tippers		40	30-01120		
Ribaltabile / Tippers		60	30-01165	30-01167	30-01169
Descrizione testata S.25mm <i>Description side board head Th.25mm.</i>		Ali da Wings to	H.700 Art.	H.800 Art.	H.900 Art.
Ribaltabile / Tippers		60	30-01171	30-01173	30-01180
Descrizione testata S.25mm <i>Description side board head Th.25mm.</i>		Ali da Wings to	H.1000 Art.	H.1100 Art.	H.1200 Art.
Laterale ribaltabile / Lateral tippers	Dx / R.	60	30-01182	30-01184	30-01186
Laterale ribaltabile / Lateral tippers	Sx / L.	60	30-01182/SX	30-01184/SX	30-01186/SX
Posteriore ribaltabile / Rear tippers	Dx / R.	60	30-01183	30-01185	30-01187
Posteriore ribaltabile / Rear tippers	Sx / L.	60	30-01183/SX	30-01185/SX	30-01187/SX

#### 30 mm.



Descrizione testata S.30mm <i>Description side board head Th.30mm.</i>		Ali da Wings to	H.400 Art.	H.500 Art.	H.600 Art.
Ribaltabile / Tippers	Dx / R.	40	30-01138		
Ribaltabile / Tippers	Sx / L.	40	30-01139		
Ribaltabile / Tippers	Dx / R.	60	30-01188	30-01191	30-01194
Ribaltabile / Tippers	Sx / L.	60	30-01189	30-01192	30-01195
Descrizione testata S.30mm <i>Description side board head Th.30mm.</i>		Ali da Wings to	H.700 Art.	H.800 Art.	H.900 Art.
Ribaltabile / Tippers	Dx / R.	60	30-01197	30-01200	30-01203
Ribaltabile / Tippers	Sx / L.	60	30-01198	30-01201	30-01204
Descrizione testata S.30mm <i>Description side board head Th.30mm.</i>		Ali da Wings to	H.1000 Art.	H.1100 Art.	H.1200 Art.
Laterale ribaltabile / Lateral tippers	Dx / R.	60	30-01206	30-01209	30-01212
Laterale ribaltabile / Lateral tippers	Sx / L.	60	30-01207	30-01210	30-01213
Posteriore ribaltabile / Rear tippers	Dx / R.	60	30-01208	30-01211	30-01214
Posteriore ribaltabile / Rear tippers	Sx / L.	60	30-01208/SX	30-01211/SX	30-01214/SX

#### Testata con bandierina S.25-S.30mm.

#### *Over hang side board head Th.25 - 30mm.*



Per montante <i>For Pillar</i>		Perno D. <i>Pin D.</i>	S.mm <i>Th.mm</i>	Ali da Wings to	H.	Art.
Normale / Normal		16	25	40	800	30-01175
Normale / Normal		16	30	40	900	30-01205
Smussato sfilabile / tippers		20	25	60	800	30-01175/P
Smussato sfilabile / tippers		20	30	60	900	30-01205/P

## Testate zincate arrotondate per montanti aperture universale

### *Galv. side board round heads for alumin. for pillars for tippers*

#### 25 mm.

Descrizione testata S.25mm <i>Description side board head Th.25mm.</i>	Ali da Wings to	H.400	H.500	H.600
		Art.	Art.	Art.
Arrot. Ribaltabile / Round for Tippers	40	30-01220		
Arrot. Ribaltabile / Round for Tippers	60	30-01221/60	30-01222/60	30-01224/60

Descrizione testata S.25mm <i>Description side board head Th.25mm.</i>	Ali da Wings to	H.700	H.800	H.900
		Art.	Art.	Art.
Arrot. Ribaltabile / Round for Tippers	60	30-01226/60	30-01228/60	30-01230/60
Arrot. Ribaltabile (art.17-00001) Round for Tippers (art.17-00001)	60		30-01229/60	

Descrizione testata S.25mm <i>Description side board head Th.25mm.</i>	Ali da Wings to	H.1000	H.1100	H.1200	
		Art.	Art.	Art.	
Lat. arrot. Ribalt./ Lat.round for tippers	Dx / R.	60	30-01232/60	30-01234/60	30-01236/60
Lat. arrot. Ribalt./ Lat.round for tippers	Sx / L.	60	30-1232/60sx	30-01234/60sx	30-01236/60sx
Post.arrot. Ribalt./ Rear round for tippers	Dx / R.	60	30-01233/60	30-01235/60	30-01237/60
Post.arrot. Ribalt./ Rear round for tippers	Sx / L.	60	30-01233/60sx	30-01235/60sx	30-01237/60sx

#### 30 mm.

Descrizione testata S.30mm <i>Description side board head Th. 30mm.</i>	Ali da Wings to	H.400	H.500	H.600	
		Art.	Art.	Art.	
Arrot. Ribaltabile / Round for Tippers	Dx / R.	40	30-01238		
Arrot. Ribaltabile / Round for Tippers	Sx / L.	40	30-01239		
Arrot. Ribaltabile / Round for Tippers	Dx / R.	60	30-01240/60	30-01241/60	30-01244/60
Arrot. Ribaltabile / Round for Tippers	Sx / L.	60	30-01240/60sx	30-01242/60	30-01245/60

Descrizione testata S.30mm <i>Description side board head Th. 30mm.</i>	Ali da Wings to	H.700	H.800	H.900	
		Art.	Art.	Art.	
Arrot. Ribaltabile / Round for Tippers	Dx / R.	60	30-01247/60	30-01250/60	30-01253/60
Arrot. Ribaltabile / Round for Tippers	Sx / L.	60	30-01248/60	30-01251/60	30-01254/60

Descrizione testata S.30mm <i>Description side board head Th. 30mm.</i>	Ali da Wings to	H.1000	H.1100	H.1200	
		Art.	Art.	Art.	
Lat. arrot. Ribalt./ Lat.round for tippers	Dx / R.	60	30-01256/60	30-01259/60	30-01262/60
Lat. arrot. Ribalt./ Lat.round for tippers	Sx / L.	60	30-01257/60	30-01260/60	30-01263/60
Post.arrot. Ribalt./ Rear round for tippers	Dx / R.	60	30-01258/60	30-01261/60	30-01264/60
Post.arrot. Ribalt./ Rear round for tippers	Sx / L.	60	30-01258/60sx	30-01261/60sx	30-01264/60sx

**Testate zincate arrotondate per montanti aperture universale*****Galv. side board round heads for alumin. for pillars for tippers***

Descrizione testata S.25mm <i>Description side board head Th.25mm.</i>	H.1000
	Art.
Arrot. Ribaltabile (senza perno e foro) <i>Round for Tippers (without pin and hole)</i>	30-01232

Descrizione testata S.30mm <i>Description side board head Th. 30mm.</i>	H.1000
	Art.
Arrot. Ribaltabile (senza perno e foro) <i>Round for Tippers (without pin and hole)</i>	30-01255

**Testate alluminio anodizzate arrotondate per montanti apertura universale*****Anod. aluminium side board round heads for alumin. for pillars for tippers***

Testata S.25mm in alluminio anodizzato <i>Anodized aluminium side board head Th.25mm.</i>	Ali da <i>Wings to</i>	H.600	H.800	H.1000
		Art.	Art.	Art.
Arrot. Ribalt. ( Anod.alluminio) (senza perno) <i>Round for tippers ( Anod.aluminium) (without pin)</i>	70	30-01267	30-01268	30-01269

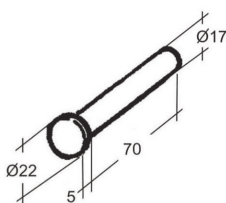
**Accessori Inox per montanti per apertura universale*****Accessories Stainless steel for pillars for tippers***

Art. 30-01275

(Kg.0,128)

Perno per testata ribaltabile Ø 22 - Ø 17 L=70 INOX  
*S.steel pin for side board head for tippers D.22-D.17 L=70*

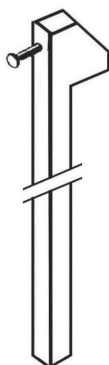
**A richiesta / On demand**

**Testate Inox con bandierina S/25 e S/30**  
**per montanti apertura universale**

**S.steel over hang side board heads**  
**Th/25 and Th/30 for tippers**

Testate INOX per montanti apertura universale

S.S. side board heads for aluminium for pillars for tippers

25 mm.



Descrizione testata S.25mm		Ali da	H.400	H.500	H.600
Description side board head Th.25mm.		Wings to	Art.	Art.	Art.
Ribaltabile / Tippers		40	30-01530		
Ribaltabile / Tippers		60	30-01577	30-01579	30-01581
Descrizione testata S.25mm		Ali da	H.700	H.800	H.900
Description side board head Th.25mm.		Wings to	Art.	Art.	Art.
Ribaltabile / Tippers		60	30-01583	30-01585	30-01587
Descrizione testata S.25mm		Ali da	H.1000	H.1100	H.1200
Description side board head Th.25mm.		Wings to	Art.	Art.	Art.
Laterale ribaltabile / Lateral tippers	Dx / R.	60	30-01589	30-01591	30-01593
Laterale ribaltabile / Lateral tippers	Sx / L.	60	30-01589/SX	30-01591/SX	30-01593/SX
Posteriore ribaltabile / Rear tippers	Dx / R.	60	30-01590	30-01592	30-01594
Posteriore ribaltabile / Rear tippers	Sx / L.	60	30-01590/SX	30-01592/SX	30-01594/SX

30 mm.



Descrizione testata S.30mm		Ali da	H.400	H.500	H.600
Description side board head Th.30mm.		Wings to	Art.	Art.	Art.
Ribaltabile / Tippers	Dx / R.	40	30-01550		
Ribaltabile / Tippers	Sx / L.	40	30-01551		
Ribaltabile / Tippers	Dx / R.	60	30-01595	30-01598	30-01601
Ribaltabile / Tippers	Sx / L.	60	30-01596	30-01599	30-01602
Descrizione testata S.30mm		Ali da	H.700	H.800	H.900
Description side board head Th.30mm.		Wings to	Art.	Art.	Art.
Ribaltabile / Tippers	Dx / R.	60	30-01604	30-01607	30-01610
Ribaltabile / Tippers	Sx / L.	60	30-01605	30-01608	30-01611
Descrizione testata S.30mm		Ali da	H.1000	H.1100	H.1200
Description side board head Th.30mm.		Wings to	Art.	Art.	Art.
Laterale ribaltabile / Lateral tippers	Dx / R.	60	30-01613	30-01616	30-01619
Laterale ribaltabile / Lateral tippers	Sx / L.	60	30-01614	30-01617	30-01620
Posteriore ribaltabile / Rear tippers	Dx / R.	60	30-01615	30-01618	30-01621
Posteriore ribaltabile / Rear tippers	Sx / L.	60	30-01615/SX	30-01618/SX	30-01621/SX

**A richiesta / On demand**

Versione inox fiorettato

= aggiungere a fine articolo la F (es: 30-01...../F)

S.s.anti-reflex treatment version

= add at the end of Article F (es: 30-01...../F)

## Testate INOX arrotondate per montanti aperture universale

### S.s. side board round heads for alumin. for pillars for tippers

#### 25 mm.

Descrizione testata S.25mm		Ali da	H.400	H.500	H.600
Description side board head Th.25mm.		Wings to	Art.	Art.	Art.
Arrot. Ribaltabile / Round for Tippers		40	30-01622		
Arrot. Ribaltabile / Round for Tippers		60	30-01670	30-01672	30-01674

Descrizione testata S.25mm		Ali da	H.700	H.800	H.900
Description side board head Th.25mm.		Wings to	Art.	Art.	Art.
Arrot. Ribaltabile / Round for Tippers		60	30-01676	30-01678	30-01680

Descrizione testata S.25mm		Ali da	H.1000	H.1100	H.1200
Description side board head Th.25mm.		Wings to	Art.	Art.	Art.
Lat. arrot. Ribalt./ Lat.round for tippers	Dx / R.	60	30-01682	30-01684	30-01686
Lat. arrot. Ribalt./ Lat.round for tippers	Sx / L.	60	30-01682/SX	30-01684/SX	30-01686/SX
Post.arrot. Ribalt./ Rear round for tippers	Dx / R.	60	30-01683	30-01685	30-01687
Post.arrot. Ribalt./ Rear round for tippers	Sx / L.	60	30-01683/SX	30-01685/SX	30-01687/SX

#### 30 mm.

Descrizione testata S.30mm		Ali da	H.400	H.500	H.600
Description side board head Th. 30mm.		Wings to	Art.	Art.	Art.
Arrot. Ribaltabile / Round for Tippers	Dx / R.	40	30-01640		
Arrot. Ribaltabile / Round for Tippers	Sx / L.	40	30-01641		
Arrot. Ribaltabile / Round for Tippers	Dx / R.	60	30-01690	30-01693	30-01696
Arrot. Ribaltabile / Round for Tippers	Sx / L.	60	30-01691	30-01694	30-01697

Descrizione testata S.30mm		Ali da	H.700	H.800	H.900
Description side board head Th. 30mm.		Wings to	Art.	Art.	Art.
Arrot. Ribaltabile / Round for Tippers	Dx / R.	60	30-01699	30-01702	30-01705
Arrot. Ribaltabile / Round for Tippers	Sx / L.	60	30-01700	30-01703	30-01706

Descrizione testata S.30mm		Ali da	H.1000	H.1100	H.1200
Description side board head Th. 30mm.		Wings to	Art.	Art.	Art.
Lat. arrot. Ribalt./ Lat.round for tippers	Dx / R.	60	30-01708	30-01711	30-01714
Lat. arrot. Ribalt./ Lat.round for tippers	Sx / L.	60	30-01709	30-01712	30-01715
Post.arrot. Ribalt./ Rear round for tippers	Dx / R.	60	30-01710	30-01713	30-01716
Post.arrot. Ribalt./ Rear round for tippers	Sx / L.	60	30-01710/SX	30-01713/SX	30-01716/SX

#### 25 mm.

Descrizione testata S.25mm		H.1000
Description side board head Th.25mm.		Art.
Arrot. Ribaltabile (senza perno e foro)	Round for Tippers (without pin and hole)	30-01681

#### 30 mm.

Descrizione testata S.30mm		H.1000
Description side board head Th. 30mm.		Art.
Arrot. Ribaltabile (senza perno e foro)	Round for Tippers (without pin and hole)	30-01707

#### A richiesta / On demand

Versione inox fioretato

S.s.anti-reflex treatment version

= aggiungere a fine articolo la F (es: 30-01...../F)

= add at the end of Article F (es: 30-01...../F)

**Sovramontante per apertura universale sp. 33**

***Extension pillars for tippers Th. 33***

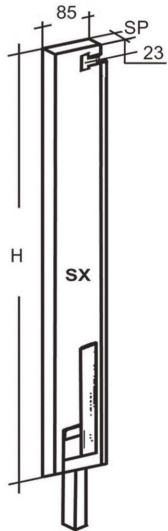

**Anteriore stretto**  
**Front (tight)**

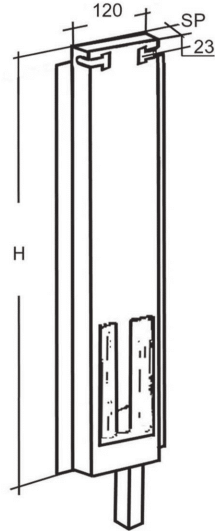

**Centrale**  
**Central**

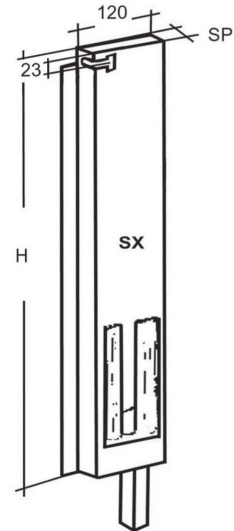

**Posteriore**  
**Rear**

Descrizione sovramontante <i>Description extension pillar</i>	L. W.		H.400	H.500	H.600
			Art.	Art.	Art.
Anteriore / Front	85	Dx / R.	30-01720	30-01727	30-01734
Anteriore / Front	85	Sx / L.	30-01721	30-01728	30-01735
Anteriore / Front	120	Dx / R.	30-01722	30-01729	30-01736
Anteriore / Front	120	Sx / L.	30-01723	30-01730	30-01737
Centrale / Central	120		30-01724	30-01731	30-01738
Posteriore / Rear	120	Dx / R.	30-01725	30-01732	30-01739
Posteriore / Rear	120	Sx / L.	30-01726	30-01733	30-01740

Descrizione sovramontante <i>Description extension pillar</i>	L. W.		H.700	H.800	
			Art.	Art.	
Anteriore / Front	85	Dx / R.	30-01741	30-01748	
Anteriore / Front	85	Sx / L.	30-01742	30-01749	
Anteriore / Front	120	Dx / R.	30-01743	30-01750	
Anteriore / Front	120	Sx / L.	30-01744	30-01751	
Centrale / Central	120		30-01745	30-01752	
Posteriore / Rear	120	Dx / R.	30-01746	30-01753	
Posteriore / Rear	120	Sx / L.	30-01747	30-01754	

## Sovramontante per apertura universale sp. 33

*Extension pillars for tippers Th.33*

(Parzialmente inox / Partially s.s.)

Descrizione sovramontante <i>Description extension pillar</i>	L. W.		H.400	H.500	H.600
			Art.	Art.	Art.
Anteriore / Front	85	Dx / R.	30-01790	30-01797	30-01804
Anteriore / Front	85	Sx / L.	30-01791	30-01798	30-01805
Anteriore / Front	120	Dx / R.	30-01792	30-01799	30-01806
Anteriore / Front	120	Sx / L.	30-01793	30-01800	30-01807
Centrale / Central	120		30-01794	30-01801	30-01808
Posteriore / Rear	120	Dx / R.	30-01795	30-01802	30-01809
Posteriore / Rear	120	Sx / L.	30-01796	30-01803	30-01810

Descrizione sovramontante <i>Description extension pillar</i>	L. W.		H.700	H.800	
			Art.	Art.	
Anteriore / Front	85	Dx / R.	30-01811	30-01818	
Anteriore / Front	85	Sx / L.	30-01812	30-01819	
Anteriore / Front	120	Dx / R.	30-01813	30-01820	
Anteriore / Front	120	Sx / L.	30-01814	30-01821	
Centrale / Central	120		30-01815	30-01822	
Posteriore / Rear	120	Dx / R.	30-01816	30-01823	
Posteriore / Rear	120	Sx / L.	30-01817	30-01824	

(Inox / S.s.)

Descrizione sovramontante <i>Description extension pillar</i>	L. W.		H.400	H.500	H.600
			Art.	Art.	Art.
Anteriore / Front	85	Dx / R.	30-01790/TI	30-01797/TI	30-01804/TI
Anteriore / Front	85	Sx / L.	30-01791/TI	30-01798/TI	30-01805/TI
Anteriore / Front	120	Dx / R.	30-01792/TI	30-01799/TI	30-01806/TI
Anteriore / Front	120	Sx / L.	30-01793/TI	30-01800/TI	30-01807/TI
Centrale / Central	120		30-01794/TI	30-01801/TI	30-01808/TI
Posteriore / Rear	120	Dx / R.	30-01795/TI	30-01802/TI	30-01809/TI
Posteriore / Rear	120	Sx / L.	30-01796/TI	30-01803/TI	30-01810/TI

Descrizione sovramontante <i>Description extension pillar</i>	L. W.		H.700	H.800	
			Art.	Art.	
Anteriore / Front	85	Dx / R.	30-01811/TI	30-01818/TI	
Anteriore / Front	85	Sx / L.	30-01812/TI	30-01819/TI	
Anteriore / Front	120	Dx / R.	30-01813/TI	30-01820/TI	
Anteriore / Front	120	Sx / L.	30-01814/TI	30-01821/TI	
Centrale / Central	120		30-01815/TI	30-01822/TI	
Posteriore / Rear	120	Dx / R.	30-01816/TI	30-01823/TI	
Posteriore / Rear	120	Sx / L.	30-01817/TI	30-01824/TI	

**A richiesta / On demand**

Versione parzialmente inox fiorettato = aggiungere a fine articolo la F (es: 30-01..... /F)  
 Partially S.s. anti-reflex treatment version = add at the end of Article F (es: 30-01..... /F)

Versione Totalmente inox fiorettato = aggiungere a fine articolo la F (es: 30-01..... /TI/F)  
 Totally S.s. anti-reflex treatment version = add at the end of Article F (es: 30-01..... /TI/F)

Sovramontante per apertura trilaterale (180°) sp.33

Extension pillar for trilateral opening (180°) Th.33

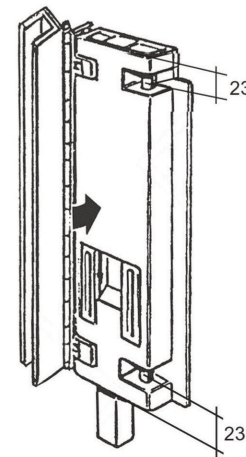
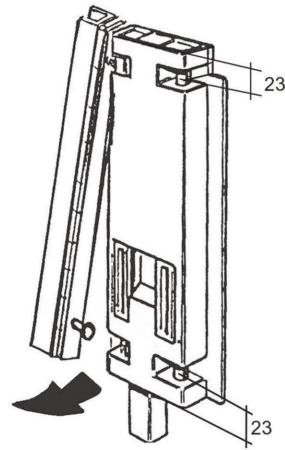

Descrizione sovrasmontante <i>Description extension pillar</i>	L. W.		H.400	H.500	H.600
			Art.	Art.	Art.
Anteriore / Front	85	Dx / R.	30-01830	30-01837	30-01844
Anteriore / Front	85	Sx / L.	30-01831	30-01838	30-01845
Anteriore / Front	120	Dx / R.	30-01832	30-01839	30-01846
Anteriore / Front	120	Sx / L.	30-01833	30-01840	30-01847
Centrale / Central	120		30-01834	30-01841	30-01848
Posteriore / Rear	120	Dx / R.	30-01835	30-01842	30-01849
Posteriore / Rear	120	Sx / L.	30-01836	30-01843	30-01850

Descrizione sovrasmontante <i>Description extension pillar</i>	L. W.		H.700	H.800	
			Art.	Art.	
Anteriore / Front	85	Dx / R.	30-01851	30-01858	
Anteriore / Front	85	Sx / L.	30-01852	30-01859	
Anteriore / Front	120	Dx / R.	30-01853	30-01860	
Anteriore / Front	120	Sx / L.	30-01854	30-01861	
Centrale / Central	120		30-01855	30-01862	
Posteriore / Rear	120	Dx / R.	30-01856	30-01863	
Posteriore / Rear	120	Sx / L.	30-01857	30-01864	

## Sovramontante per apertura trilaterale (180°) sp.33

*Extension pillar for trilateral opening (180°) Th.33***(Parzialmente inox / Partially s.s.)**

Descrizione sovramontante <i>Description extension pillar</i>	L. W.		H.400	H.500	H.600
			Art.	Art.	Art.
Anteriore / <i>Front</i>	85	Dx / R.	30-01910	30-01917	30-01924
Anteriore / <i>Front</i>	85	Sx / L.	30-01911	30-01918	30-01925
Anteriore / <i>Front</i>	120	Dx / R.	30-01912	30-01919	30-01926
Anteriore / <i>Front</i>	120	Sx / L.	30-01913	30-01920	30-01927
Centrale / <i>Central</i>	120		30-01914	30-01921	30-01928
Posteriore / <i>Rear</i>	120	Dx / R.	30-01915	30-01922	30-01929
Posteriore / <i>Rear</i>	120	Sx / L.	30-01916	30-01923	30-01930

Descrizione sovramontante <i>Description extension pillar</i>	L. W.		H.700	H.800	
			Art.	Art.	
Anteriore / <i>Front</i>	85	Dx / R.	30-01931	30-01938	
Anteriore / <i>Front</i>	85	Sx / L.	30-01932	30-01939	
Anteriore / <i>Front</i>	120	Dx / R.	30-01933	30-01940	
Anteriore / <i>Front</i>	120	Sx / L.	30-01934	30-01941	
Centrale / <i>Central</i>	120		30-01935	30-01942	
Posteriore / <i>Rear</i>	120	Dx / R.	30-01936	30-01943	
Posteriore / <i>Rear</i>	120	Sx / L.	30-01937	30-01944	

**(Inox / S.s.)**

Descrizione sovramontante <i>Description extension pillar</i>	L. W.		H.400	H.500	H.600
			Art.	Art.	Art.
Anteriore / <i>Front</i>	85	Dx / R.	30-01910/TI	30-01917/TI	30-01924/TI
Anteriore / <i>Front</i>	85	Sx / L.	30-01911/TI	30-01918/TI	30-01925/TI
Anteriore / <i>Front</i>	120	Dx / R.	30-01912/TI	30-01919/TI	30-01926/TI
Anteriore / <i>Front</i>	120	Sx / L.	30-01913/TI	30-01920/TI	30-01927/TI
Centrale / <i>Central</i>	120		30-01914/TI	30-01921/TI	30-01928/TI
Posteriore / <i>Rear</i>	120	Dx / R.	30-01915/TI	30-01922/TI	30-01929/TI
Posteriore / <i>Rear</i>	120	Sx / L.	30-01916/TI	30-01923/TI	30-01930/TI

Descrizione sovramontante <i>Description extension pillar</i>	L. W.		H.700	H.800	
			Art.	Art.	
Anteriore / <i>Front</i>	85	Dx / R.	30-01931/TI	30-01938/TI	
Anteriore / <i>Front</i>	85	Sx / L.	30-01932/TI	30-01939/TI	
Anteriore / <i>Front</i>	120	Dx / R.	30-01933/TI	30-01940/TI	
Anteriore / <i>Front</i>	120	Sx / L.	30-01934/TI	30-01941/TI	
Centrale / <i>Central</i>	120		30-01935/TI	30-01942/TI	
Posteriore / <i>Rear</i>	120	Dx / R.	30-01936/TI	30-01943/TI	
Posteriore / <i>Rear</i>	120	Sx / L.	30-01937/TI	30-01944/TI	

**A richiesta / On demand**

Versione parzialmente inox fiorettato = aggiungere a fine articolo la F (es: 30-01..... /F)  
 Partially S.s. anti-reflex treatment version = add at the end of Article F (es: 30-01..... /F)

Versione Totalmente inox fiorettato = aggiungere a fine articolo la F (es: 30-01..... /TI/F)  
 Totally S.s. anti-reflex treatment version = add at the end of Article F (es: 30-01..... /TI/F)

Testate zincate per sovramontanti per apertura trilaterale (180°)

Galvanized side board heads for extension pillars for trilateral opening (180°)

Descrizione testata S.25mm <i>Description side board head Th.25mm.</i>	H.400	H.500	H.600	H.700	H.800
	Art.	Art.	Art.	Art.	Art.
180 °	30-01882	30-01885	30-01888	30-01891	30-01894
Doppio perno / <i>Double pin</i>	30-01882/S	30-01885/S	30-01888/S	30-01891/S	30-01894/S

Descrizione testata S.30mm <i>Description side board head Th.30mm.</i>	H.400	H.500	H.600	H.700	H.800
	Art.	Art.	Art.	Art.	Art.
180 °	30-01897	30-01900	30-01903	30-01906	30-01909
Doppio perno / <i>Double pin</i>	30-01897/S	30-01900/S	30-01903/S	30-01906/S	30-01909/S

Testate inox per sovramontante per apertura trilaterale (180°)

S.steel side board heads for extension pillars for trilateral opening (180°)

Descrizione testata S.25mm <i>Description side board head Th.25mm.</i>	H.400	H.500	H.600	H.700	H.800
	Art.	Art.	Art.	Art.	Art.
180 °	30-01952	30-01955	30-01958	30-01961	30-01964
Doppio perno / <i>Double pin</i>	30-01952/s	30-01955/s	30-01958/s	30-01961/s	30-01964/s

Descrizione testata S.30mm <i>Description side board head Th.30mm.</i>	H.400	H.500	H.600	H.700	H.800
	Art.	Art.	Art.	Art.	Art.
180 °	30-01972	30-01975	30-01978	30-01981	30-01984
Doppio perno / <i>Double pin</i>	30-01972/s	30-01975/s	30-01978/s	30-01981/s	30-01984/s

**A richiesta / On demand**

Versione inox fiorettato = aggiungere a fine articolo la F (es: 30-01...../F)  
 S.s.anti-reflex treatment version = add at the end of Article F (es: 30-01...../F)

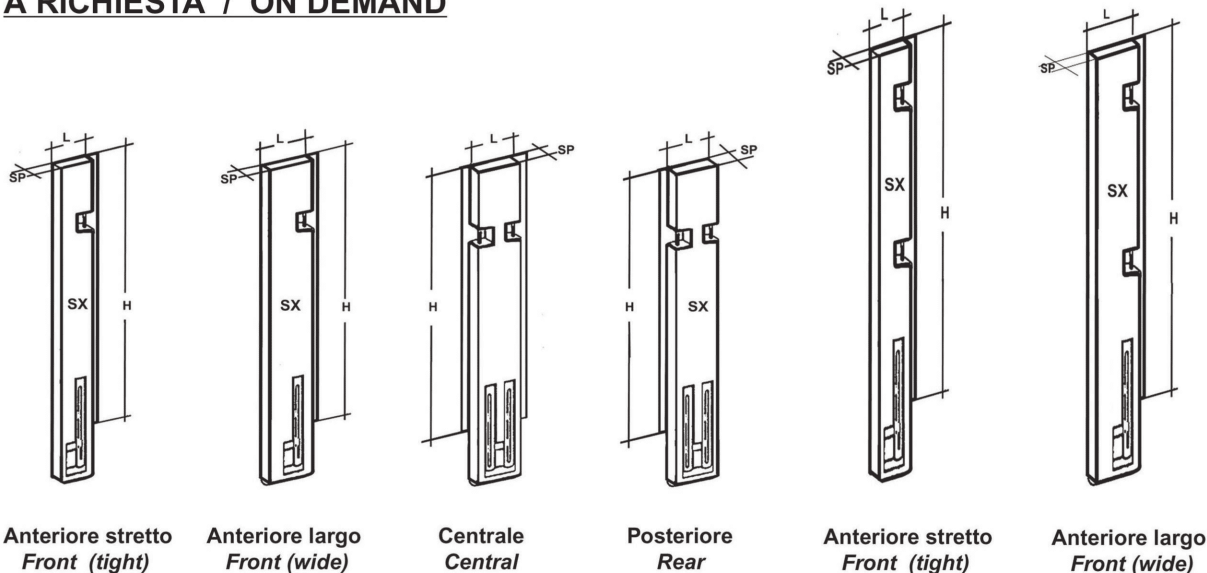
**Montanti a semplice apertura rovesciabili per sponde TR5 Sp.41*****Overturning pillars for simple opening for TR5 profiles Th.41*****A RICHIESTA / ON DEMAND**Anteriore stretto  
Front (tight)Anteriore largo  
Front (wide)Centrale  
CentralPosteriore  
RearAnteriore stretto  
Front (tight)Anteriore largo  
Front (wide)

Descrizione montante Description pillar	L		H. 400	H. 500	H. 600
			Art.	Art.	Art.
Ant. / Front	85	Dx / R.	30-02350	30-02358	30-02366
Ant. / Front	85	Sx / L.	30-02351	30-02359	30-02367
Ant. / Front	120	Dx / R.	30-02352	30-02360	30-02368
Ant. / Front	120	Sx / L.	30-02353	30-02361	30-02369
Cent. / Cent.	120		30-02354	30-02362	30-02370
Post. / Rear	120	Dx / R.	30-02355	30-02363	30-02371
Post. / Rear	120	Sx / L.	30-02356	30-02364	30-02372

Descrizione montante Description pillar	L		H.700	H.800	H.900
			Art.	Art.	Art.
Ant. / Front	85	Dx / R.	30-02374	30-02382	30-02390
Ant. / Front	85	Sx / L.	30-02375	30-02383	30-02391
Ant. / Front	120	Dx / R.	30-02376	30-02384	30-02392
Ant. / Front	120	Sx / L.	30-02377	30-02385	30-02393
Cent. / Cent.	120		30-02378	30-02386	30-02394
Post. / Rear	120	Dx / R.	30-02379	30-02387	30-02395
Post. / Rear	120	Sx / L.	30-02380	30-02388	30-02396

Descrizione montante Description pillar	L		H.1000	H.1100	H.1200
			Art.	Art.	Art.
Ant. / Front	85	Dx / R.	30-02398	30-02406	30-02414
Ant. / Front	85	Sx / L.	30-02399	30-02407	30-02415
Ant. / Front	120	Dx / R.	30-02400	30-02408	30-02416
Ant. / Front	120	Sx / L.	30-02401	30-02409	30-02417
Cent. / Cent.	120		30-02402	30-02410	30-02418
Post. / Rear	120	Dx / R.	30-02403	30-02411	30-02419
Post. / Rear	120	Sx / L.	30-02404	30-02412	30-02420

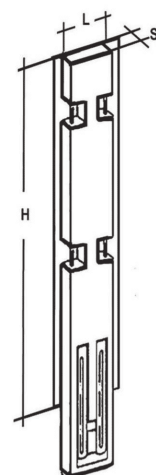
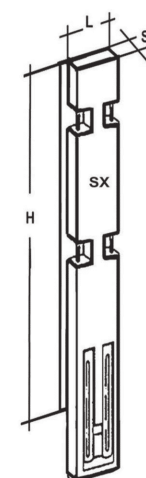
Centrale  
CentralPosteriore  
Rear

**Montanti per apertura universale rovesciabili per sponda TR5 sp.41**

**Overturning pillars for tippers for TR5 profiles Th. 41**

**A RICHIESTA / ON DEMAND**

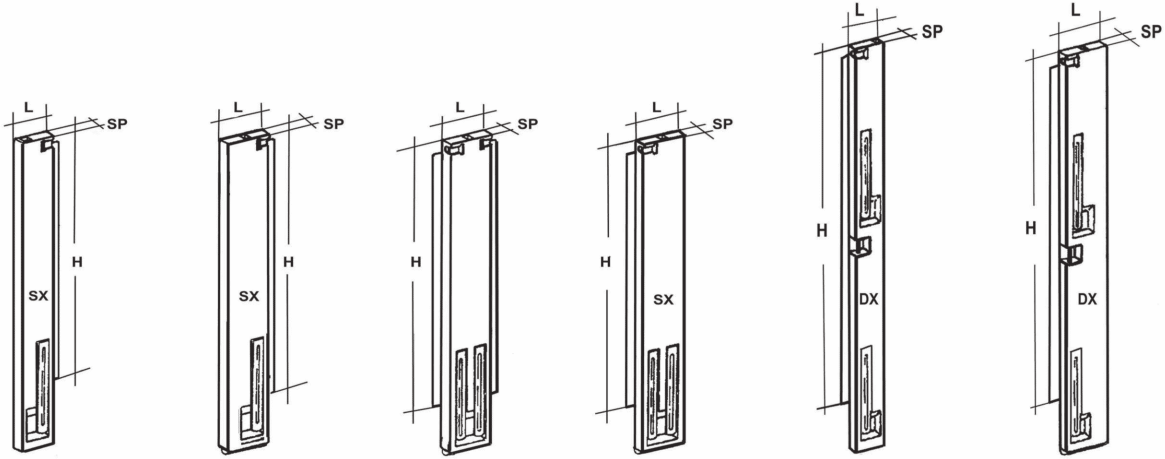

Anteriore stretto  
Front (tight)

Anteriore largo  
Front (wide)

Centrale  
Central

Posteriore  
Rear

Anteriore stretto  
Front (tight)

Anteriore largo  
Front (wide)

Descrizione montante Description pillar	L		H. 400	H. 500	H. 600
			Art.	Art.	Art.
Ant. / Front	85	Dx / R.	30-02422	30-02429	30-02436
Ant. / Front	85	Sx / L.	30-02423	30-02430	30-02437
Ant. / Front	120	Dx / R.	30-02424	30-02431	30-02438
Ant. / Front	120	Sx / L.	30-02425	30-02432	30-02439
Cent. / Cent.	120		30-02426	30-02433	30-02440
Post. / Rear	120	Dx / R.	30-02427	30-02434	30-02441
Post. / Rear	120	Sx / L.	30-02428	30-02435	30-02442

Descrizione montante Description pillar	L		H.700	H.800	H.900
			Art.	Art.	Art.
Ant. / Front	85	Dx / R.	30-02443	30-02450	30-02457
Ant. / Front	85	Sx / L.	30-02444	30-02451	30-02458
Ant. / Front	120	Dx / R.	30-02445	30-02452	30-02459
Ant. / Front	120	Sx / L.	30-02446	30-02453	30-02460
Cent. / Cent.	120		30-02447	30-02454	30-02461
Post. / Rear	120	Dx / R.	30-02448	30-02455	30-02462
Post. / Rear	120	Sx / L.	30-02449	30-02456	30-02463

Descrizione montante Description pillar	L		H.1000	H.1100	H.1200
			Art.	Art.	Art.
Ant. / Front	85	Dx / R.	30-02464	30-02471	30-02478
Ant. / Front	85	Sx / L.	30-02465	30-02472	30-02479
Ant. / Front	120	Dx / R.	30-02466	30-02473	30-02480
Ant. / Front	120	Sx / L.	30-02467	30-02474	30-02481
Cent. / Cent.	120		30-02468	30-02475	30-02482
Post. / Rear	120	Dx / R.	30-02469	30-02476	30-02483
Post. / Rear	120	Sx / L.	30-02470	30-02477	30-02484

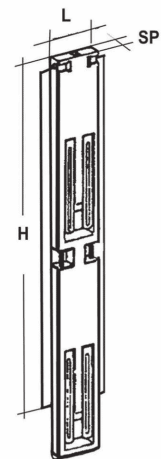

Centrale  
Central

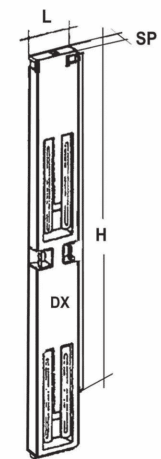

Posteriore  
Rear

## Montanti per apertura universale sfilabili per sponda TR5 sp.41

*A richiesta / On demand*

### *Removable pillars for tippers for profiles TR5 Th.41*

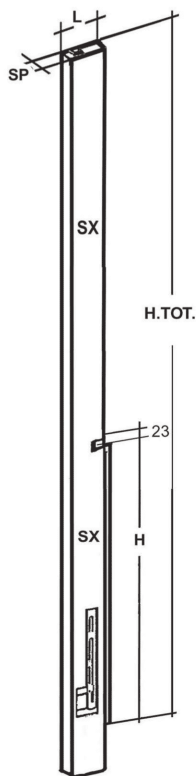

**Anteriore alto**  
*High Front*

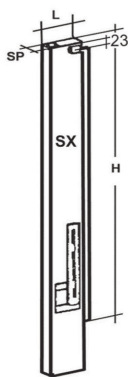

**Anteriore stretto**  
*Front (tight)*

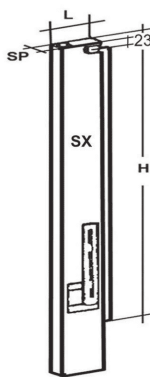

**Anteriore largo**  
*Front (wide)*

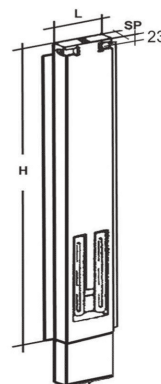

**Centrale**  
*Central*

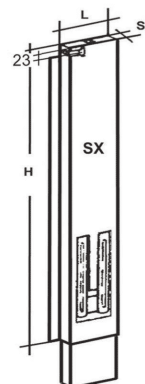

**Posteriore**  
*Rear*

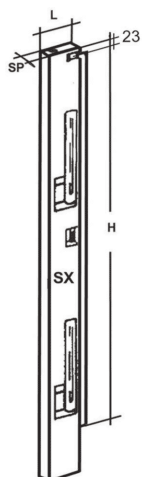

**Anteriore stretto**  
*Front (tight)*

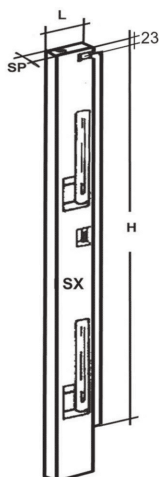

**Anteriore largo**  
*Front (wide)*

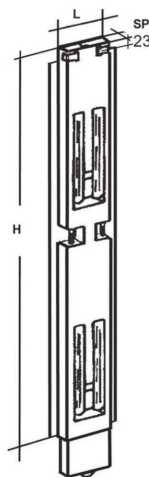

**Centrale**  
*Central*

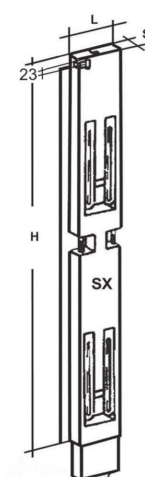

**Posteriore**  
*Rear*

**Montanti per apertura universale sfilabili per sponda TR5 sp.41**

**A richiesta / On demand**

**Removable pillars for tippers for profiles TR5 Th.41**

Descrizione montante <i>Description pillar</i>	L. W.		H.400	H.500	H.600
			Art.	Art.	Art.
Anteriore / Front - H.tot.1600	85	Dx / R.	30-02493/L		
Anteriore / Front - H.tot.1600	85	Sx / L.	30-02494/L		
Anteriore / Front - H.tot.1800	85	Dx / R.		30-02500/L	30-02507/L
Anteriore / Front - H.tot.1800	85	Sx / L.		30-02501/L	30-02508/L
Anteriore / Front	85	Dx / R.	30-02493	30-02500	30-02507
Anteriore / Front	85	Sx / L.	30-02494	30-02501	30-02508
Anteriore / Front	120	Dx / R.	30-02495	30-02502	30-02509
Anteriore / Front	120	Sx / L.	30-02496	30-02503	30-02510
Ant.con innesto / Front with male part	120	Dx / R.	30-02495/S	30-02502/S	30-02509/S
Ant.con innesto / Front with male part	120	Sx / L.	30-02496/S	30-02503/S	30-02510/S
Centrale / Central	120		30-02497	30-02504	30-02511
Posteriore / Rear	120	Dx / R.	30-02498	30-02505	30-02512
Posteriore / Rear	120	Sx / L.	30-02499	30-02506	30-02513

Descrizione montante <i>Description pillar</i>	L. W.		H.700	H.800	H.900
			Art.	Art.	Art.
Anteriore / Front - H.tot.1800	85	Dx / R.	30-02514/L	30-02521/L	
Anteriore / Front - H.tot.1800	85	Sx / L.	30-02515/L	30-02522/L	
Anteriore / Front	85	Dx / R.	30-02514	30-02521	30-02528
Anteriore / Front	85	Sx / L.	30-02515	30-02522	30-02529
Anteriore / Front	120	Dx / R.	30-02516	30-02523	30-02530
Anteriore / Front	120	Sx / L.	30-02517	30-02524	30-02531
Ant.con innesto / Front with male part	120	Dx / R.	30-02516/S	30-02523/S	30-02530/S
Ant.con innesto / Front with male part	120	Sx / L.	30-02517/S	30-02524/S	30-02531/S
Centrale / Central	120		30-02518	30-02525	30-02532
Posteriore / Rear	120	Dx / R.	30-02519	30-02526	30-02533
Posteriore / Rear	120	Sx / L.	30-02520	30-02527	30-02534

Descrizione montante <i>Description pillar</i>	L. W.		H.1000	H.1100	H.1200
			Art.	Art.	Art.
Anteriore / Front	85	Dx / R.	30-02535	30-02542	30-02549
Anteriore / Front	85	Sx / L.	30-02536	30-02543	30-02550
Anteriore / Front	120	Dx / R.	30-02537	30-02544	30-02551
Anteriore / Front	120	Sx / L.	30-02538	30-02545	30-02552
Ant.con innesto / Front with male	120	Dx / R.	30-02537/S	30-02544/S	30-02551/S
Ant.con innesto / Front with male part	120	Sx / L.	30-02538/S	30-02545/S	30-02552/S
Centrale / Central	120		30-02539	30-02546	30-02553
Posteriore / Rear	120	Dx / R.	30-02540	30-02547	30-02554
Posteriore / Rear	120	Sx / L.	30-02541	30-02548	30-02555

**Montanti doppia altezza per apertura universale sfilabili  
per sponda TR5 sp.41**

***Double pillars for profiles TR5 Th.41 removables for tippers***

Art.	Descrizione montante / Description pillar
30-02487	Posteriore Dx - Laterale H.400 - Posteriore H.500 <i>Removable double rear right pillar for tipper side H.400 rear H.500</i>
30-02488	Posteriore Sx - Laterale H.400 - Posteriore H.500 <i>Removable double rear left pillar for tipper side H.400 rear H.500</i>
30-02489	Posteriore Dx - Laterale H.500 - Posteriore H.600 <i>Removable double rear right pillar for tipper side H.500 rear H.600</i>
30-02490	Posteriore Sx - Laterale H.500 - Posteriore H.600 <i>Removable double rear left pillar for tipper side H.500 rear H.600</i>
30-02491	Posteriore Dx - Laterale H.600 - Posteriore H.700 <i>Removable double rear right pillar for tipper side H.600 rear H.700</i>
30-02492	Posteriore Sx - Laterale H.600 - Posteriore H.700 <i>Removable double rear left pillar for tipper side H.600 rear H.700</i>
30-02485	Posteriore Dx - Laterale H.700 - Posteriore H.800 <i>Removable double rear right pillar for tipper side H.700 rear H.800</i>
30-02486	Posteriore Sx - Laterale H.700 - Posteriore H.800 <i>Removable double rear left pillar for tipper side H.700 rear H.800</i>

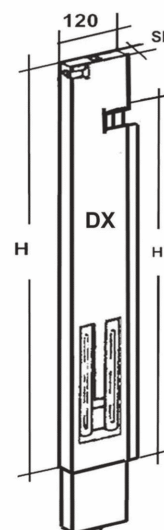

**Montanti doppia altezza per apertura universale sfilabili smussati  
per sponda TR5 sp.41**

***Double pillars for profiles TR5 Th.41 removables for tippers***

Art.	Descrizione montante / Description pillar
30-02487/HS	Posteriore Dx - Laterale H.400 - Posteriore H.500 <i>Removable double rear right pillar for tipper side H.400 rear H.500</i>
30-02488/HS	Posteriore Sx - Laterale H.400 - Posteriore H.500 <i>Removable double rear left pillar for tipper side H.400 rear H.500</i>
30-02489/HS	Posteriore Dx - Laterale H.500 - Posteriore H.600 <i>Removable double rear right pillar for tipper side H.500 rear H.600</i>
30-02490/HS	Posteriore Sx - Laterale H.500 - Posteriore H.600 <i>Removable double rear left pillar for tipper side H.500 rear H.600</i>
30-02491/HS	Posteriore Dx - Laterale H.600 - Posteriore H.700 <i>Removable double rear right pillar for tipper side H.600 rear H.700</i>
30-02492/HS	Posteriore Sx - Laterale H.600 - Posteriore H.700 <i>Removable double rear left pillar for tipper side H.600 rear H.700</i>
30-02485/HS	Posteriore Dx - Laterale H.700 - Posteriore H.800 <i>Removable double rear right pillar for tipper side H.700 rear H.800</i>
30-02486/HS	Posteriore Sx - Laterale H.700 - Posteriore H.800 <i>Removable double rear left pillar for tipper side H.700 rear H.800</i>

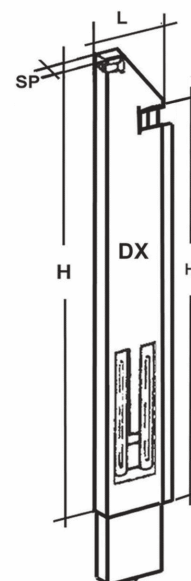

**Accessori per montanti per sponda TR5 ( BANDIERINA )**

**Accessories for pillars for profiles TR5 ( Pin overhang )**

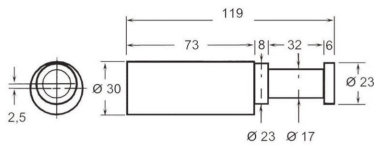

**Art. 30-01274 - Art. 30-01274/Z (zinc / galv.)** (Kg.0,505)  
Perno per profilo TR5 / Pin for profile TR5

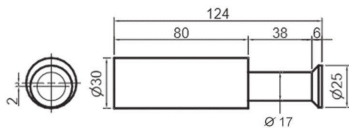

**Art. 30-01278** (Kg.0,530)  
Perno eccentrico zinc. per testata TR5  
Zinc plated eccentric pin for head TR5

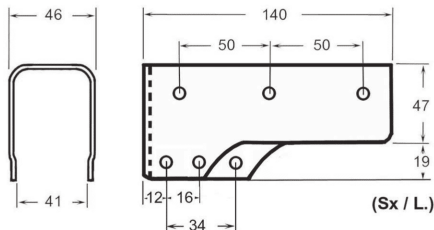

**Art. 30-02595 (DX) - Art. 30-02595/SX** (Kg.0,425)  
Supporto per TR5 porta bandierina zincato  
Galv. support for pin overhang for profiles TR5

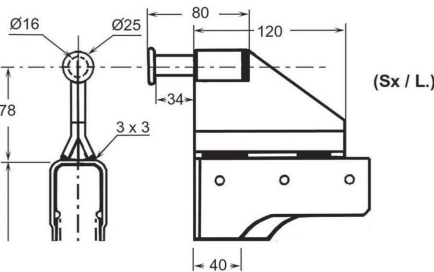

**Art. 30-02596 (DX) - Art. 30-02596/SX**  
Supporto per TR5 porta bandierina nero  
Raw support for pin overhang for profiles TR5

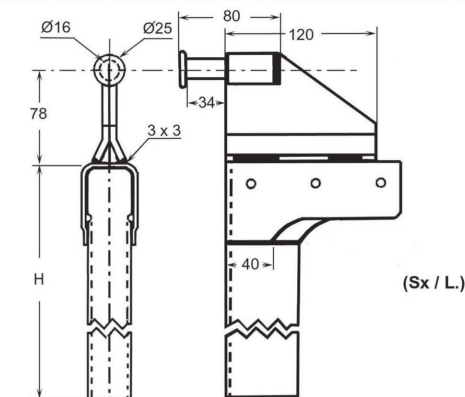

**Art. 30-02597 (DX) - Art. 30-02597/SX** (Kg.1,377)  
Supporto con bandierina per testate TR5 zincato  
Galvanized support for overhang pin for side board heads for profiles TR5

**Art. 30-02598 (DX) - Art. 30-02598/SX** (Kg.2,500)  
Testate per TR5 con bandierina zincate H.400  
Galvanized overhang side board heads H.400

**Art. 30-02599 (DX) - Art. 30-02599/SX** (Kg.3,146)  
Testate per TR5 con bandierina zincate H.800  
Galvanized overhang side board heads H.800

**Testate serie leggera per montanti per sponda TR5 ( BANDIERINA )**

**Side board heads light series for pillars for profiles TR5 ( Pin overhang )**

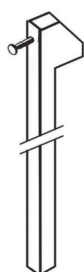

Descrizione tesa		H.400/500	H.800/900
Description sideboard head		Art.	Art.
Acciaio zincato / Galvanized steel	Dx/R.	30-02590/DX	30-02592/DX
Acciaio zincato / Galvanized steel	Sx/L.	30-02590/SX	30-02592/SX

**Testate per montanti per sponde TR5 ( senza perno e senza foro )****Side board heads for pillars for profiles TR5 (without pin and hole)**

Descrizione testata <i>Description side board head</i>		H.400	H.600	H.800
		Art.	Art.	Art.
All.anod./Anod.Allum.(senza foro/without hole)	Dx/R.	30-02557	30-02558	30-02559
All.anod./Anod.Allum.(senza foro/without hole)	Sx/L.	30-02557/SX	30-02558/SX	30-02559/SX
Acc.zinc/Galv.steel (senza foro/without hole)	Dx/R.			30-02579
Acc.zinc/Galv.steel (senza foro/without hole)	Sx/L.			30-02579/SX

**Testate per montanti per sponde TR5 ( senza perno con foro )****Side board heads for pillars for profiles TR5 (without pin/with hole)**

Descrizione testata <i>Description side board head</i>		H.400	H.500	H.600	H.700	H.800	H.900
		Art.	Art.	Art.	Art.	Art.	Art.
Allum.anod/ Anod.Allum.	Dx/R.	30-02560	30-02561	30-02562		30-02563	
Allum.anod/ Anod.Allum.	Sx/L.	30-02560/SX	30-02561/SX	30-02562/SX		30-02563/SX	
Acc.zinc/Galv.steel	Dx/R.	30-02570	30-02571	30-02572	30-02573	30-02574	30-02575
Acc.zinc/Galv.steel	Sx/L.	30-02570/SX	30-02571/SX	30-02572/SX	30-02573/SX	30-02574/SX	30-02575/SX
Inox / Stainless steel	Dx/R.	30-02580	30-02581	30-02582	30-02583	30-02584	30-02585
Inox / Stainless steel	Sx/L.	30-02580/SX	30-02581/SX	30-02582/SX	30-02583/SX	30-02584/SX	30-02585/SX

Descrizione testata <i>Description side board head</i>		H.1000	H.1100	H.1200
		Art.	Art.	Art.
All.anod./Anod.alum.	Dx/R.	30-02564	30-02565	30-02566
All.anod./Anod.alum.	Sx/L.	30-02564/SX	30-02565/SX	30-02566/SX
Acc.zinc./Galv.steel	Dx/R.	Lat / Lat	30-02576	30-02577
Acc.zinc./Galv.steel	Sx/L.	Lat / Lat	30-02576/SX	30-02577/SX
Acc.zinc./Galv.steel	Dx/R.	Pos/Rear	30-02576P	30-02577P
Acc.zinc./Galv.steel	Sx/L.	Pos/Rear	30-02576P/SX	30-02577P/SX
Inox / Stainless steel	Dx/R.	Lat / Lat	30-02586	30-02587
Inox / Stainless steel	Sx/L.	Lat / Lat	30-02586/SX	30-02587/SX
Inox / Stainless steel	Dx/R.	Pos/Rear	30-02586P	30-02587P
Inox / Stainless steel	Sx/L.	Pos/Rear	30-02586P/SX	30-02587P/SX

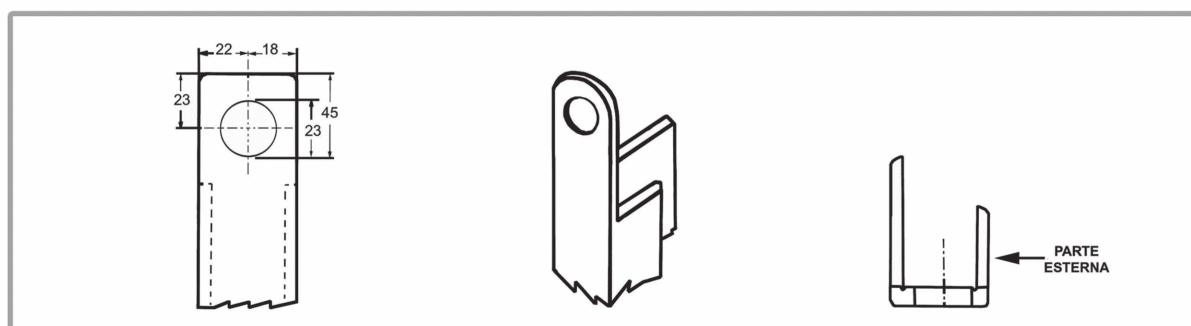

Sovramontante per apertura universale per sponda TR5 sp.41

Extension pillars for tippers for profiles TR5 Th.41

A RICHIESTA / ON DEMAND

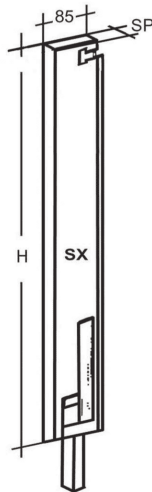

Anteriore stretto  
Front (tight)

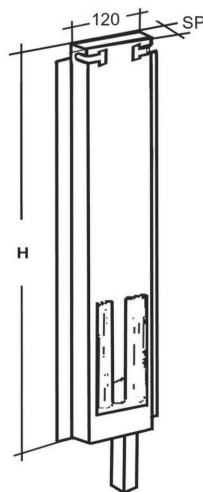

Centrale  
Central

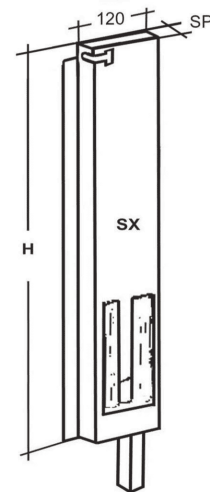

Posteriore  
Rear

Descrizione sovramontante Description extension pillar	L. W.		H.400	H.500	H.600
			Art.	Art.	Art.
Anteriore / Front	85	Dx / R.	30-02750	30-02760	30-02770
Anteriore / Front	85	Sx / L.	30-02751	30-02761	30-02771
Anteriore / Front	120	Dx / R.	30-02752	30-02762	30-02772
Anteriore / Front	120	Sx / L.	30-02753	30-02763	30-02773
Centrale / Central	120		30-02754	30-02764	30-02774
Posteriore / Rear	120	Dx / R.	30-02755	30-02765	30-02775
Posteriore / Rear	120	Sx / L.	30-02756	30-02766	30-02776

Descrizione sovramontante Description extension pillar	L. W.		H.700	H.800	
			Art.	Art.	
Anteriore / Front	85	Dx / R.	30-02780	30-02790	
Anteriore / Front	85	Sx / L.	30-02781	30-02791	
Anteriore / Front	120	Dx / R.	30-02782	30-02792	
Anteriore / Front	120	Sx / L.	30-02783	30-02793	
Centrale / Central	120		30-02784	30-02794	
Posteriore / Rear	120	Dx / R.	30-02785	30-02795	
Posteriore / Rear	120	Sx / L.	30-02786	30-02796	

**Sovramontante per apertura trilaterale (180°) per sponda TR5 sp.41**

**Extension pillar for trilateral opening (180°) for profiles TR5 with Th.41**

**A RICHIESTA / ON DEMAND**



Descrizione sovramontante <i>Description extension pillar</i>	L. W.		H.400	H.500	H.600
			Art.	Art.	Art.
Anteriore / Front	85	Dx / R.	30-02800	30-02810	30-02820
Anteriore / Front	85	Sx / L.	30-02801	30-02811	30-02821
Anteriore / Front	120	Dx / R.	30-02802	30-02812	30-02822
Anteriore / Front	120	Sx / L.	30-02803	30-02813	30-02823
Centrale / Central	120		30-02804	30-02814	30-02824
Posteriore / Rear	120	Dx / R.	30-02805	30-02815	30-02825
Posteriore / Rear	120	Sx / L.	30-02806	30-02816	30-02826

Descrizione sovramontante <i>Description extension pillar</i>	L. W.		H.700	H.800	
			Art.	Art.	
Anteriore / Front	85	Dx / R.	30-02830	30-02840	
Anteriore / Front	85	Sx / L.	30-02831	30-02841	
Anteriore / Front	120	Dx / R.	30-02832	30-02842	
Anteriore / Front	120	Sx / L.	30-02833	30-02843	
Centrale / Central	120		30-02834	30-02844	
Posteriore / Rear	120	Dx / R.	30-02835	30-02845	
Posteriore / Rear	120	Sx / L.	30-02836	30-02846	

**Testate zincate per sovrasmontanti per apertura trilaterale (180°)**  
**per sponda TR5 sp.41**

**Side board heads for extension pillars for trilateral opening (180°)**  
**for profiles TR5 with Th.41**

**A RICHIESTA / ON DEMAND**

Descrizione testata <i>Description</i>		H.400 Art.	H.500 Art.	H.600 Art.
180 ° zincata / Galvanized 180°	Dx / R.	30-02900	30-02902	30-02904
180 ° zincata / Galvanized 180°	Sx / L.	30-02901	30-02903	30-02905
Doppio perno zinc. / Galv. Double pin	Dx / R.	30-02900/S	30-02902/S	30-02904/S
Doppio perno zinc. / Galv. Double pin	Sx / L.	30-02901/S	30-02903/S	30-02905/S

Descrizione testata <i>Description</i>		H.700 Art.	H.800 Art.	
180 ° zincata / Galvanized 180°	Dx / R.	20-02906	30-02908	
180 ° zincata / Galvanized 180°	Sx / L.	30-02907	30-02909	
Doppio perno zinc. / Galv. Double pin	Dx / R.	20-02906/S	30-02908/S	
Doppio perno zinc. / Galv. Double pin	Sx / L.	30-02907/S	30-02909/S	

## Montanti per apertura universale sfilabili per sponde in ferro Sp.46

### Removables pillars for tippers for sides in iron with Th.46

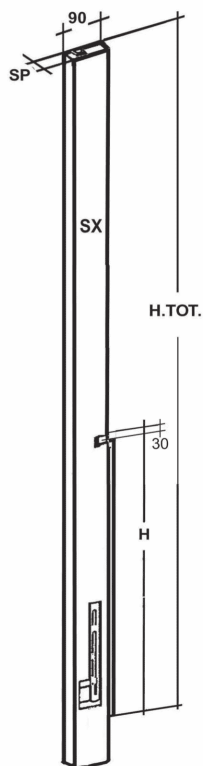

Anteriore alto  
High Front

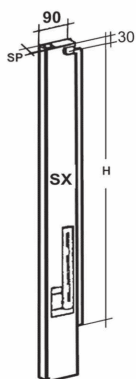

Anteriore stretto  
Front (tight)

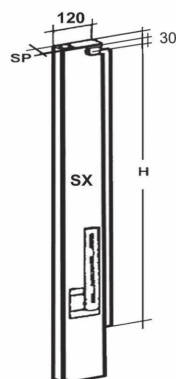

Anteriore largo  
Front (wide)

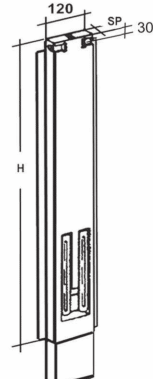

Centrale  
Central

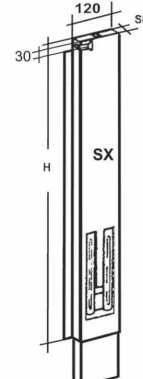

Posteriore  
Rear

Descrizione montante Description pillar	L. W.		H.400	H.500	H.600
			Art.	Art.	Art.
Anteriore / Front - H.tot.1800	90	Dx / R.	30-02600/L	30-02610/L	30-02620/L
Anteriore / Front - H.tot.1800	90	Sx / L.	30-02601/L	30-02611/L	30-02621/L
Anteriore / Front	90	Dx / R.	30-02600	30-02610	30-02620
Anteriore / Front	90	Sx / L.	30-02601	30-02611	30-02621
Anteriore / Front	120	Dx / R.	30-02607	30-02617	30-02627
Anteriore / Front	120	Sx / L.	30-02608	30-02618	30-02628
Ant.con innesto / Front with male part	120	Dx / R.	30-02600/S	30-02610/S	30-02620/S
Ant.con innesto / Front with male part	120	Sx / L.	30-02601/S	30-02611/S	30-02621/S
Centrale / Central	120		30-02602	30-02612	30-02622
Posteriore / Rear	120	Dx / R.	30-02603	30-02613	30-02623
Posteriore / Rear	120	Sx / L.	30-02604	30-02614	30-02624

Descrizione montante Description pillar	L. W.		H.700	H.800	
			Art.	Art.	
Anteriore / Front - H.tot.1800	90	Dx / R.	30-02630/L	30-02640/L	
Anteriore / Front - H.tot.1800	90	Sx / L.	30-02631/L	30-02641/L	
Anteriore / Front	90	Dx / R.	30-02630	30-02640	
Anteriore / Front	90	Sx / L.	30-02631	30-02641	
Anteriore / Front	120	Dx / R.	30-02637	30-02647	
Anteriore / Front	120	Sx / L.	30-02638	30-02648	
Ant.con innesto / Front with male part	120	Dx / R.	30-02630/S	30-02640/S	
Ant.con innesto / Front with male part	120	Sx / L.	30-02631/S	30-02641/S	
Centrale / Central	120		30-02632	30-02642	
Posteriore / Rear	120	Dx / R.	30-02633	30-02643	
Posteriore / Rear	120	Sx / L.	30-02634	30-02644	

**Montanti doppia altezza per apertura universale sfilabili**  
**per sponda Sp.46**

***Removables double pillars for tippers with Th.46***

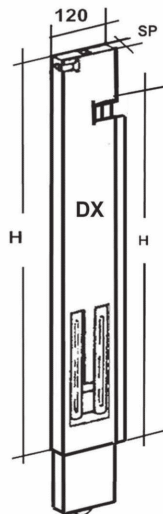

Art.	Descrizione montante / Description pillar
30-02605	Posteriore Dx - Laterale H.400 - Posteriore H.500 <i>Removable double rear right pillar for tipper side H.400 rear H.500</i>
30-02606	Posteriore Sx - Laterale H.400 - Posteriore H.500 <i>Removable double rear left pillar for tipper side H.400 rear H.500</i>
30-02615	Posteriore Dx - Laterale H.500 - Posteriore H.600 <i>Removable double rear right pillar for tipper side H.500 rear H.600</i>
30-02616	Posteriore Sx - Laterale H.500 - Posteriore H.600 <i>Removable double rear left pillar for tipper side H.500 rear H.600</i>
30-02625	Posteriore Dx - Laterale H.600 - Posteriore H.700 <i>Removable double rear right pillar for tipper side H.600 rear H.700</i>
30-02626	Posteriore Sx - Laterale H.600 - Posteriore H.700 <i>Removable double rear left pillar for tipper side H.600 rear H.700</i>
30-02635	Posteriore Dx - Laterale H.700 - Posteriore H.800 <i>Removable double rear right pillar for tipper side H.700 rear H.800</i>
30-02636	Posteriore Sx - Laterale H.700 - Posteriore H.800 <i>Removable double rear left pillar for tipper side H.700 rear H.800</i>

**Montanti doppia altezza per apertura universale sfilabili smussati**  
**per sponda Sp.46**

***Removables double pillars for tippers with Th.46***

***A richiesta / On demand***

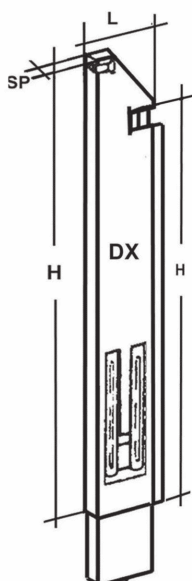

Art.	Descrizione montante / Description pillar
30-02605/HS	Posteriore Dx - Laterale H.400 - Posteriore H.500 <i>Removable double rear right pillar for tipper side H.400 rear H.500</i>
30-02606/HS	Posteriore Sx - Laterale H.400 - Posteriore H.500 <i>Removable double rear left pillar for tipper side H.400 rear H.500</i>
30-02615/HS	Posteriore Dx - Laterale H.500 - Posteriore H.600 <i>Removable double rear right pillar for tipper side H.500 rear H.600</i>
30-02616/HS	Posteriore Sx - Laterale H.500 - Posteriore H.600 <i>Removable double rear left pillar for tipper side H.500 rear H.600</i>
30-02625/HS	Posteriore Dx - Laterale H.600 - Posteriore H.700 <i>Removable double rear right pillar for tipper side H.600 rear H.700</i>
30-02626/HS	Posteriore Sx - Laterale H.600 - Posteriore H.700 <i>Removable double rear left pillar for tipper side H.600 rear H.700</i>
30-02635/HS	Posteriore Dx - Laterale H.700 - Posteriore H.800 <i>Removable double rear right pillar for tipper side H.700 rear H.800</i>
30-02636/HS	Posteriore Sx - Laterale H.700 - Posteriore H.800 <i>Removable double rear left pillar for tipper side H.700 rear H.800</i>

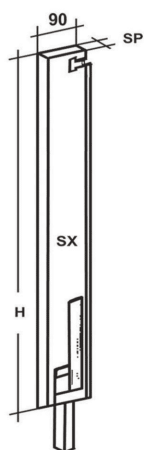
**Sovramontante per apertura universale per sponda Sp.46*****Extension pillar for tippers with Th.46*****A RICHIESTA / ON DEMAND**

Anteriore stretto  
*Front (tight)*

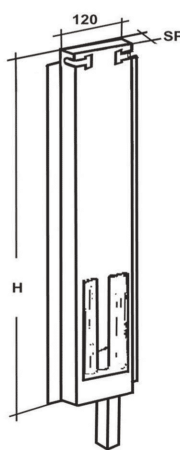

Centrale  
*Central*

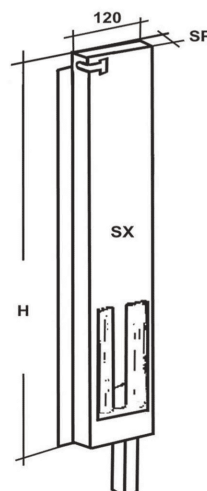

Posteriore  
*Rear*

Descrizione sovramontante <i>Description extension pillar</i>	L. W.		H.400	H.500	H.600
			Art.	Art.	Art.
Anteriore / <i>Front</i>	90	Dx / R.	30-02850	30-02860	30-02870
Anteriore / <i>Front</i>	90	Sx / L.	30-02851	30-02861	30-02871
Anteriore / <i>Front</i>	120	Dx / R.	30-02852	30-02862	30-02872
Anteriore / <i>Front</i>	120	Sx / L.	30-02853	30-02863	30-02873
Centrale / <i>Central</i>	120		30-02854	30-02864	30-02874
Posteriore / <i>Rear</i>	120	Dx / R.	30-02855	30-02865	30-02875
Posteriore / <i>Rear</i>	120	Sx / L.	30-02856	30-02866	30-02876

Descrizione sovramontante <i>Description extension pillar</i>	L. W.		H.700	H.800	
			Art.	Art.	
Anteriore / <i>Front</i>	90	Dx / R.	30-02880	30-02890	
Anteriore / <i>Front</i>	90	Sx / L.	30-02881	30-02891	
Anteriore / <i>Front</i>	120	Dx / R.	30-02882	30-02892	
Anteriore / <i>Front</i>	120	Sx / L.	30-02883	30-02893	
Centrale / <i>Central</i>	120		30-02884	30-02894	
Posteriore / <i>Rear</i>	120	Dx / R.	30-02885	30-02895	
Posteriore / <i>Rear</i>	120	Sx / L.	30-02886	30-02896	

**Accessori per montanti per apertura universale sfilabili per sponde in ferro sp.46**

**Accessories for removable pillars for tippers with Th.46**

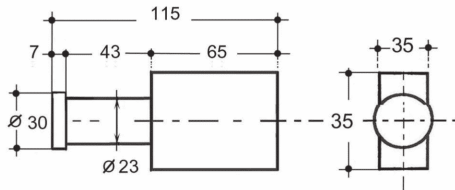

**Art. 30-02699**

Perni per montanti per sponde in ferro Sp. 46 D.23  
Pin D. 23 for pillars for side in iron with Th. 46  
(Kg.0,680)

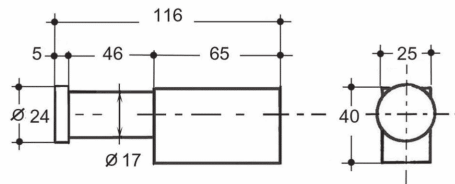

**Art. 30-02700**

Perni per montanti per sponde in ferro Sp. 46 D. 17  
Pin D. 17 for pillars for side in iron with Th. 46  
(Kg.0,600)

**Montanti e testate per chiusure sponde posteriori Sp.33**

**Pillars and side board heads for back sides with Th.33**

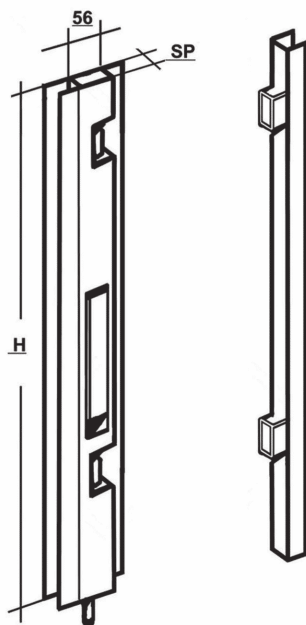

Descrizione montante <i>Description pillar</i>	H. 600	H. 800	H. 1000
	Art.	Art.	Art.
Montante / Pillar	30-03000	30-03001	30-03002

Descrizione testata <i>Description side board head</i>	H. 600	H. 800	H. 1000
	Art.	Art.	Art.
Testata zinc. / Galv. side board head	30-03100	30-03101	30-03102

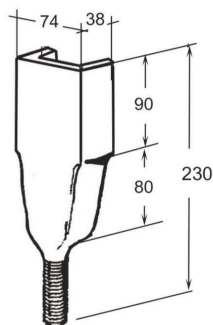
INNESTI PER MONTANTIHOUSES FOR PILLARS**Art. 30-04502**

Innesto per montanti tipo leggero modificato maschio  
*House for pillar (male modified) - Light version*  
 (Kg.1,768)

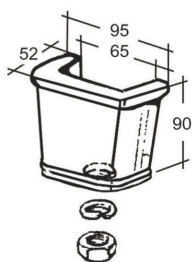
**Art. 30-04503**

Innesto per montanti tipo leggero modificato femmina  
*House for pillar (female modified) - Light version*  
 (Kg.1,152)

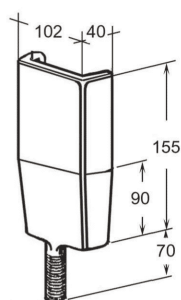
**Art. 30-04506**

Innesto per montanti tipo pesante maschio  
*House for pillar (male) - Heavy version*  
 (Kg.4,583)

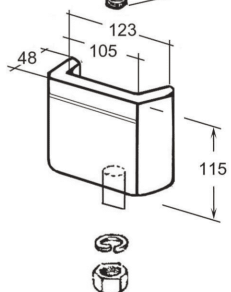
**Art. 30-04507**

Innesto per montanti tipo pesante femmina  
*House for pillar (female) - Heavy version*  
 (Kg.3,045)

INNESTI PER MONTANTI

HOUSES FOR PILLARS

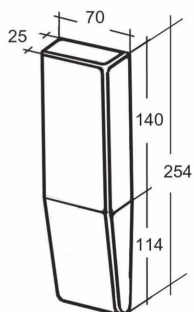

**Art. 30-04504**

Cuneo per montante per sponde alluminio sp.25 mm.  
*Wedge for pillar for aluminium side with Th. 25 mm.*  
 (Kg.1,610)

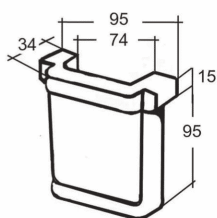

**Art. 30-04505**

Sede per cuneo / *Wedge for pillar*  
 (Kg.1,020)

**Art. 30-04505/L**

Sede per cuneo in lamiera / *Wedge for pillar (sheet metal)*  
 (Kg.0,468)

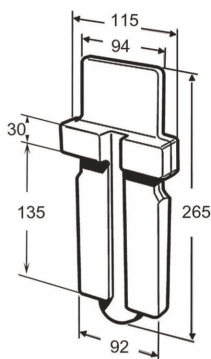

**Art. 30-04511**

Innesto per montanti tipo Verona  
*House for pillar (male Verona type)*  
 (Kg.3,463)

**Art. 30-04511/I**

Innesto per montanti tipo Verona INOX  
*Stainless steel house for pillar (male Verona type)*  
 (Kg.3,463)

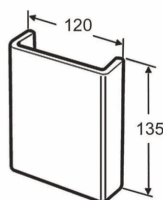

**Art. 30-04512**

Sede per innesto per montanti tipo Verona  
*House for pillar (female Verona type)*  
 (Kg.1,760)

**Art. 30-04512/I**

Sede per innesto per montanti tipo Verona INOX  
*Stainless steel house for pillar (female Verona type)*  
 (Kg.1,780)

## Montanti "R 5" Sp.33 (con staffe)

## Pillars "R 5" Th.33 (with brackets)

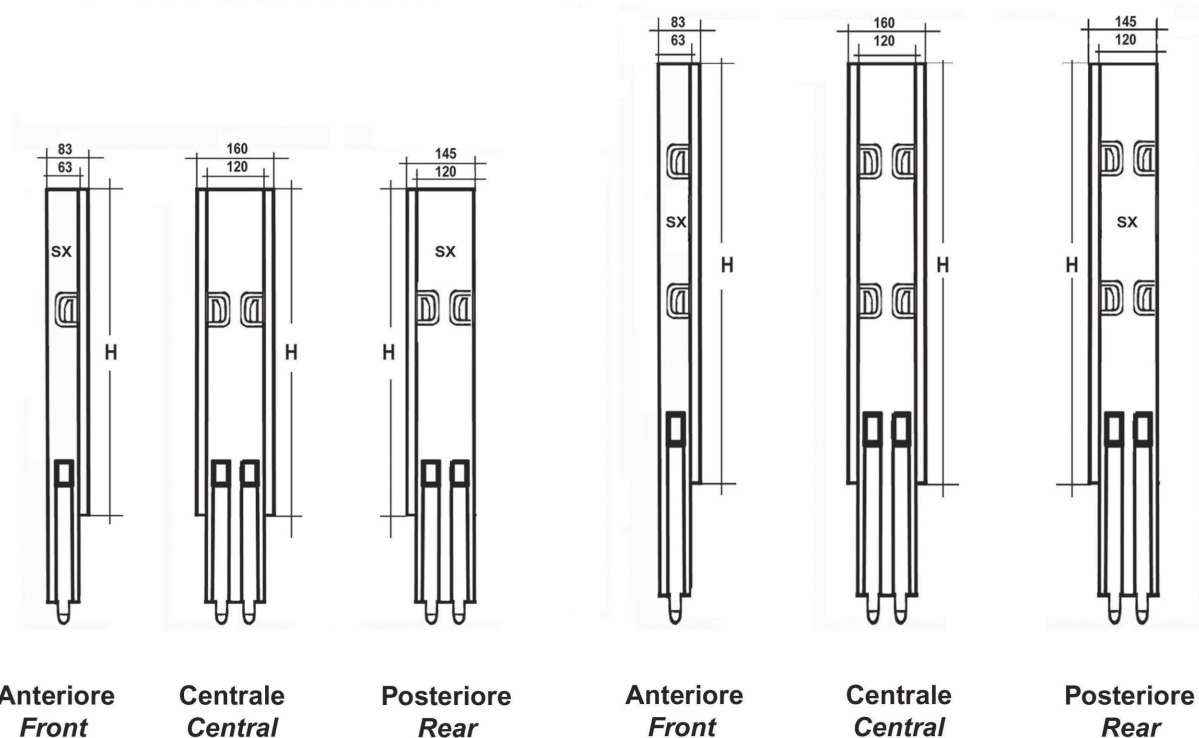

A richiesta / On demand

Descrizione montante <i>Description pillar</i>		Leve <i>Lever</i>	H.400	H.600	H.800
			Art.	Art.	Art.
Anteriore / <i>Front</i>	Dx / R.	1	30-02100	30-02108	30-02116
Anteriore / <i>Front</i>	Sx / L.	1	30-02101	30-02109	30-02117
Centrale / <i>Central</i>		2	30-02104	30-02112	30-02120
Posteriore / <i>Rear</i>	Dx / R.	2	30-02105	30-02113	30-02121
Posteriore / <i>Rear</i>	Sx / L.	2	30-02106	30-02114	30-02122
Centrale kinnetop / <i>Central kinnetop</i>		2	30-02107	30-02115	30-02123

Descrizione montante <i>Description pillar</i>		Leve <i>Lever</i>	Chiusure <i>Closure</i>	H.1000	H.1200
				Art.	Art.
Anteriore / <i>Front</i>	Dx / R.	1	2	30-02124	30-02132
Anteriore / <i>Front</i>	Sx / L.	1	2	30-02125	30-02133
Centrale / <i>Central</i>		2	4	30-02128	30-02136
Posteriore / <i>Rear</i>	Dx / R.	2	4	30-02129	30-02137
Posteriore / <i>Rear</i>	Sx / L.	2	4	30-02130	30-02138
Centrale kinnetop / <i>Central kinnetop</i> ...		2	4	30-02131	30-02139

## Montanti "R20" Sp.33 (con staffe)

## Pillars "R20"Th.33 (with brackets)

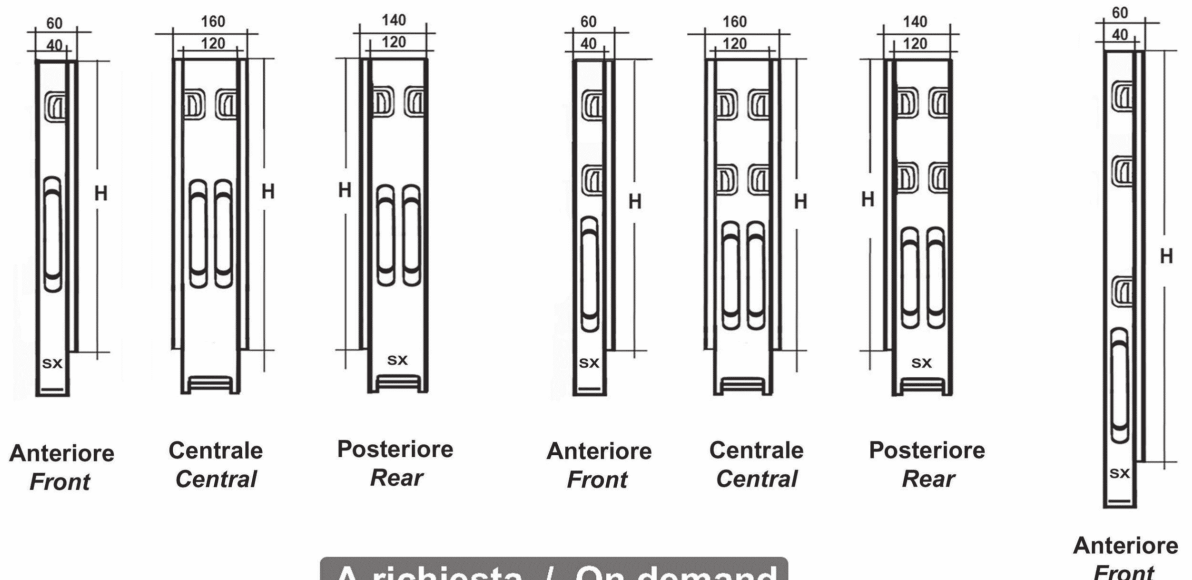

**A richiesta / On demand**

Descrizione montante <i>Description pillar</i>		Leve <i>Lever</i>	H.400 Art.	H.500 Art.	H.600 Art.	H.800 Art.
Anteriore / Front	Dx / R.	1	30-02200	30-02207	30-02215	30-02223
Anteriore / Front	Sx / L.	1	30-02201	30-02208	30-02216	30-02224
Centrale / Central		2	30-02204	30-02211	30-02219	30-02227
Posteriore / Rear	Dx / R.	2	30-02205	30-02212	30-02220	30-02228
Posteriore / Rear	Sx / L.	2	30-02206	30-02213	30-02221	30-02229
Centr. Kinnetop / Centr.kinnetop				30-02214	30-02222	30-02230

Descrizione montante <i>Description pillar</i>		Leve <i>Lever</i>	Chiusure <i>Closure</i>	Taschette <i>Pockets</i>	H.800 Art.	H.1000
Anteriore / Front	Dx / R.			2	30-02231	
Anteriore / Front	Sx / L.			2	30-02232	
Centrale / Central				4	30-02235	
Posteriore / Rear	Dx / R.			4	30-02236	
Posteriore / Rear	Sx / L.			4	30-02237	
Centr. Kinnetop / Centr.kinnetop				4	30-02238	
Anteriore / Front	Dx / R.	1	2			30-02239
Anteriore / Front	Sx / L.	1	2			30-02240
Centrale / Central		2	4			30-02243
Posteriore / Rear	Dx / R.	2	4			30-02244
Posteriore / Rear	Sx / L.	2	4			30-02245
Centr. Kinnetop / Centr.kinnetop		2	4			30-02246

Descrizione montante <i>Description pillar</i>		Leve <i>Lever</i>	Chiusure <i>Closure</i>		H.1100 Art.	H.1200 Art.
Anteriore / Front	Dx / R.	1	3		30-02247	30-02255
Anteriore / Front	Sx / L.	1	3		30-02248	30-02256
Centrale / Central		2	6		30-02251	30-02259
Posteriore / Rear	Dx / R.	2	6		30-02252	30-02260
Posteriore / Rear	Sx / L.	2	6		30-02253	30-02261
Centr. Kinnetop / Centr.kinnetop		2	6		30-02254	30-02262

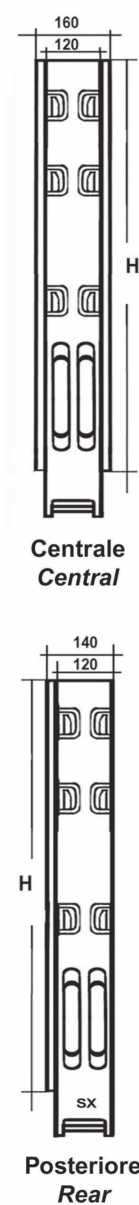

PILLARS ACCESSORIES AND FITTINGS

## Montanti "R20" Sp.33 (con staffe)

## Pillars "R20"Th.33 (with brackets)

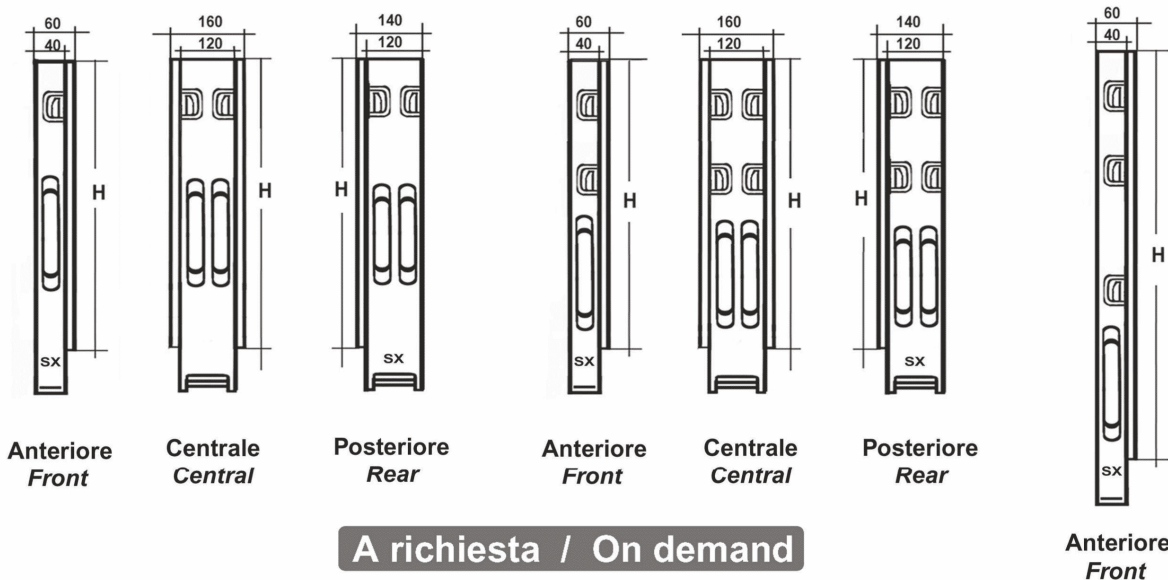

(Alluminio con leve Inox - Aluminium with levers S.s.)

Descrizione montante <i>Description pillar</i>		Leve <i>Lever</i>	H.400	H.500	H.600	H.800
			Art.	Art.	Art.	Art.
Anteriore / <i>Front</i>	Dx / R.	1	30-02270	30-02278	30-02286	30-02294
Anteriore / <i>Front</i>	Sx / L.	1	30-02271	30-02279	30-02287	30-02295
Centrale / <i>Central</i>		2	30-02274	30-02282	30-02290	30-02298
Posteriore / <i>Rear</i>	Dx / R.	2	30-02275	30-02283	30-02291	30-02299
Posteriore / <i>Rear</i>	Sx / L.	2	30-02276	30-02284	30-02292	30-02300
Centr. Kinnetop / <i>Centr.kinnetop</i>				30-02285	30-02293	30-02301

Descrizione montante <i>Description pillar</i>		Leve <i>Lever</i>	Chiusure <i>Closure</i>	Taschette <i>Pockets</i>	H.800	H.1000
					Art.	
Anteriore / <i>Front</i>	Dx / R.			2	30-02302	
Anteriore / <i>Front</i>	Sx / L.			2	30-02303	
Centrale / <i>Central</i>				4	30-02306	
Posteriore / <i>Rear</i>	Dx / R.			4	30-02307	
Posteriore / <i>Rear</i>	Sx / L.			4	30-02308	
Centr. Kinnetop / <i>Centr.kinnetop</i>				4	30-02309	
Anteriore / <i>Front</i>	Dx / R.	1	2			30-02310
Anteriore / <i>Front</i>	Sx / L.	1	2			30-02311
Centrale / <i>Central</i>		2	4			30-02314
Posteriore / <i>Rear</i>	Dx / R.	2	4			30-02315
Posteriore / <i>Rear</i>	Sx / L.	2	4			30-02316
Centr. Kinnetop / <i>Centr.kinnetop</i>		2	4			30-02317

Descrizione montante <i>Description pillar</i>		Leve <i>Lever</i>	Chiusure <i>Closure</i>	Taschette <i>Pockets</i>	H.1100	H.1200
					Art.	Art.
Anteriore / <i>Front</i>	Dx / R.	1	3		30-02318	30-02326
Anteriore / <i>Front</i>	Sx / L.	1	3		30-02319	30-02327
Centrale / <i>Central</i>		2	6		30-02322	30-02330
Posteriore / <i>Rear</i>	Dx / R.	2	6		30-02323	30-02331
Posteriore / <i>Rear</i>	Sx / L.	2	6		30-02324	30-02332
Centr. Kinnetop / <i>Centr.kinnetop</i>		2	6		30-02325	30-02333

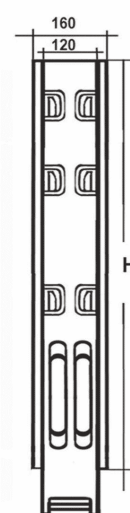
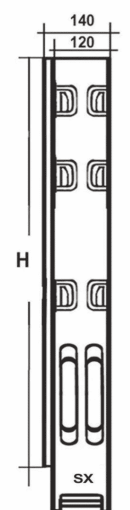
Centrale  
*Central*Posteriore  
*Rear*

Accessori per montanti " R5 "

Accessories for pillars " R5 "

**A richiesta / On demand**

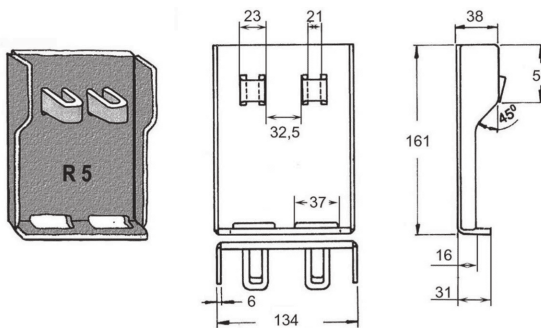

**Art. 30-02334**

Staffa a saldare da 63mm.per montante R5  
Solder bracket to 63mm. for pillar R5  
(Kg.0,710)

**Art. 30-02335**

Staffa a saldare da 120mm.per montante R5  
Solder bracket to 120mm.for pillar R5  
(Kg.1,386)

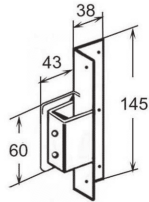

**Art. 30-02146**

Attacco su angolare laterale zincato sp.25  
per montanti R5  
Galvanized strike with angle  
for pillars R5 - Th.25

(Kg.0,298)

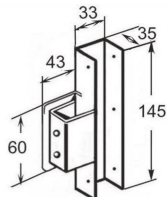

**Art. 30-02147**

Attacco su angolare posteriore zincato sp.25  
per montanti R5  
Galvanized rear strike with U profile  
for pillars R5

(Kg.0,370)

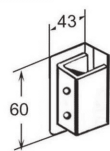

**Art. 30-02150**

Taschetta a saldare grezza per montanti R5  
Side strike for pillars R5

(Kg.0,145)

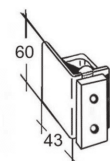

**Art. 30-02148**

Attacco registrabile laterale zincato per piantoni R5  
Galvanized side strike adjustable for pillar R5

(Kg. 0,205)

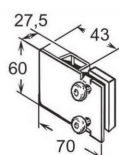

**Art. 30-02149**

Attacco registrabile posteriore zincato per piantoni R5  
Galvanized rear strike adjustable for pillar R5

(Kg. 0,212)

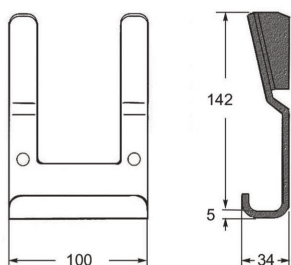
Accessori per montanti "R20"Accessories for pillars "R20"**A richiesta / On demand****Art. 30-02336**

(Kg.0,573)

Supporto a saldare per montanti R 20

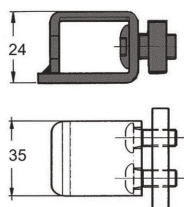
*Support Solder for pillars R 20***Art. 30-02337**

(Kg.0,120)

Taschetta zincata registrabile viti + piastrina per montanti R 20

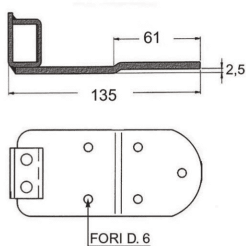
*Galvanized side strike adjustable plate + screws for pillars R20***Art. 30-02338**

(Kg.0,300)

Taschetta zincata da rivettare viti + piastrina posteriore per montanti R 20

*Galvanized side strike to be riveted plate + screws rear for pillars R 20*