

**Cerniere per cassone
fisso e a doppia apertura**

***Fixed load body hinges and
double opening hinges***

31



RE-ALL

Cerniere per sponde in alluminio da cassone fisso

Aluminium side board hinges for fixed load body

Art. 31-00001/C Kit cerniera infilare zincata / Kit galvanized hinge

Art. 31-00002
Cerniera in ferro D.13
Forged hinge raw D.13
(Kg.0,205)

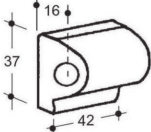

Art. 31-00048
Piastrina a 2 fori zincata int. 30
Galv. back plate interaxis 30 mm
(Kg.0,036)

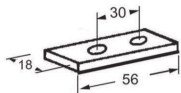

Art. 31-00001
Perno cerniera infilare zinc. D.12
Galvanized forged pin D.12
(Kg.0,206)

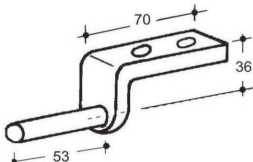

Art. 31-00075
Brugola zincata D.8MA x 18
Galv. screw D.8MA x 18
(Kg.0,011) ***A richiesta / On demand***



Art. 31-00004/C Kit cerniera infilare in alluminio / Kit aluminium hinge

Art. 31-00004
Cerniera in alluminio D.13
Aluminium Hinge D.13
(Kg.0,052)

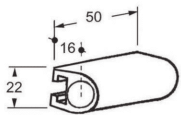

Art. 31-00048
Piastrina a 2 fori zincata int. 30
Galv. back plate interaxis 30 mm
(Kg.0,036)

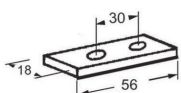

Art. 31-00001
Perno cerniera infilare zinc. D.12
Galvanized forged pin D.12
(Kg.0,206)

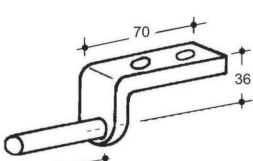

Art. 31-00075
Brugola zincata D.8MA x 18
Galv. screw D.8MA x 18
(Kg.0,011) ***A richiesta / On demand***



Cerniere per sponde in alluminio da cassone fisso***Aluminium side board hinges for fixed load body***

Art. 31-00005/C Kit cerniera TIR piccola / Kit light TIR hinge

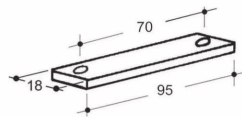
**Art. 31-00007**

Piastrina a 2 fori zincata int. 70
Galv. Back plate Int.70
(Kg.0,074)

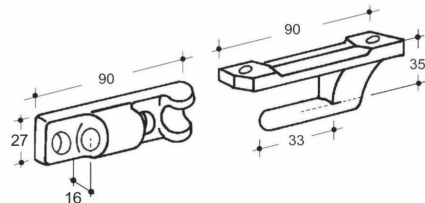
**Art. 31-00005**

Perno cern.TIR piccola zinc.D.12
Galvanized Light TIR pin D.12
(Kg.0,225)

Art. 31-00006

Cerniera per TIR piccola D.13
Light TIR hinge D=13
(Kg. 0,180)

**Art. 31-00077**

Vite a "T" svasata D.8MAx22
Countersunk head screw D.8MAx22
(Kg.0,010) **A richiesta / On demand**

Art. 31-00006/C Kit cerniera TIR piccola zincata / Kit galv. light TIR

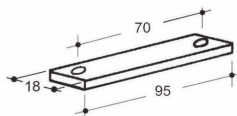
**Art. 31-00007**

Piastrina a 2 fori zincata int. 70
Galv. Back plate Int.70
(Kg.0,074)

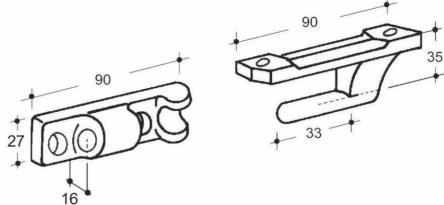
**Art. 31-00005**

Perno cern.TIR piccola zinc.D.12
Galvanized Light TIR pin D.12
(Kg.0,225)

Art. 31-00006/Z

Cerniere per TIR piccola D.13 zincata
Galvanized Light TIR hinge D.13
(Kg.0,180)

**A richiesta / On demand****Art. 31-00077**

Vite a "T" svasata D.8MAx22
Countersunk head screw D.8MAx22
(Kg.0,010)

Art. 31-00032/C Kit cerniera TIR piccola inox / Kit stainless steel light TIR hinge

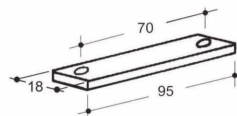
**Art. 31-00007**

Piastrina a 2 fori zincata int. 70
Galv. Back plate Int.70
(Kg.0,074)

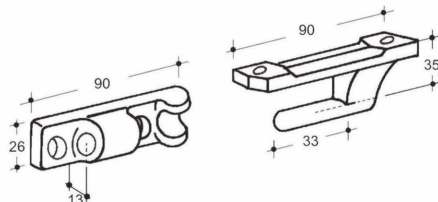
**Art. 31-00032**

Perno cern.TIR piccola inox D.12
Stainless steel light TIR pin
(Kg.0,225)

Art. 31-00033

Cerniera per TIR piccola inox D.13
Stainless steel light TIR hinge D.13
(Kg.0,180)

**A richiesta / On demand****Art. 31-00077**

Vite a "T" svasata D.8MAx22
Countersunk head screw D.8MAx22
(Kg.0,010)

Cerniere per sponde in alluminio da cassone fisso

Aluminium side board hinges for fixed load body

Art. 31-00008/C Kit cerniera TIR grande / Kit heavy TIR hinge

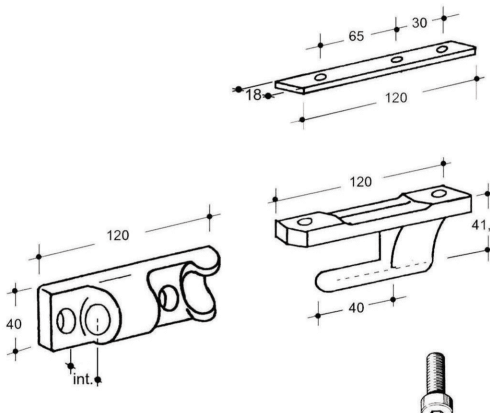

Art. 31-00003
Piastrina a 3 fori zinc.int.30+65
Galv. Back plate Int.30+65
(Kg.0,093)

Art. 31-00008
Perno cern. TIR grande D.15 zinc.
Galvanized heavy TIR pin D.15
(Kg.0,393)

Art. 31-00009
Cerniera per TIR grande int.16 - D.16
Heavy TIR hinge int.16 - D.16
(Kg.0,400)

A richiesta / On demand

Art. 31-00074
Brugola zincata D.8MA x 16
Galvanized screw D.8MA x 16
(Kg.0,010)

(opzioni / options)

Art. 31-00009/Z
Cerniera per TIR grande zinc.int.16 D.16 / Galvanized Heavy TIR hinge D.16 Int.16 (Kg.0,429)

Art. 31-00009/A
Cerniera per TIR grande int.18 D.16 / Heavy TIR hinge D.16 Int.18 (Kg.0,405)

Art. 31-00009/AZ
Cerniera per TIR grande zinc.int.18 D.16 / Galvanized Heavy TIR hinge D.16 Int.18 (Kg.0,429)

Art.31-00009/F
Cerniera Tir grande senza fori int.16 - D.16 / Heavy TIR hinge int.16 - D.16 (without holes) (Kg.0,400)

A richiesta / On demand

Art. 31-00030/C Kit cerniera TIR grande inox / Kit stainless steel heavy TIR hinge

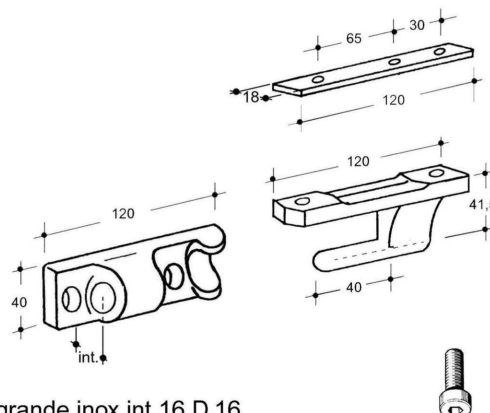

Art. 31-00003
Piastrina a 3 fori zinc.int.30+65
Galv. Back plate Int.30+65
(Kg.0,093)

Art. 31-00030
Perno cern. TIR grande inox D.15
Stainless steel heavy TIR pin D.15
(Kg.0,415)

Art. 31-00031
Cerniera per TIR grande inox int.16 D.16
Stainless steel heavy TIR hinge int.16 D.16
(Kg.0,400)

A richiesta / On demand

Art. 31-00074
Brugola zincata D.8MA x 16
Galvanized screw D.8MA x 16
(Kg.0,010)

Cerniere per sponde in alluminio da cassone fisso

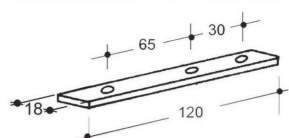
*Aluminium side board hinges for fixed load body*Art. 31-00026/C Kit cern.TIR alta zinc.con perno inclinato / *Kit galv.heavy TIR pin high and*

Art. 31-00003 (Kg.0,093)
Piastrina a 3 fori zinc.int.30+65
Galv. Back plate Int.30+65

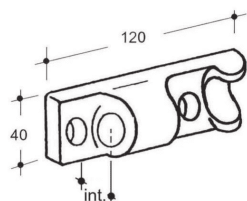

Art. 31-00009 (Kg.0,400)
Cerniera per TIR grande int.16 - D.16
Heavy TIR hinge int.16 - D.16

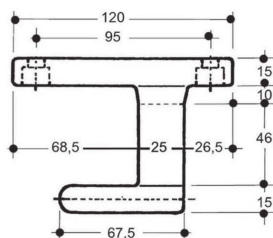

Art. 31-00026 (Kg.0,550)
Perno cern.TIR alto inclinato e fresato zinc. D.15
Galvanized heavy TIR pin high and D.15
(Kg.0,550)

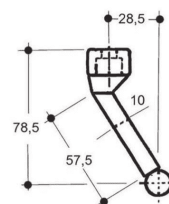

Art. 31-00074
Brugola zincata D.8MA x 16
Galvanized screw D.8MA x 16
(Kg.0,010) **A richiesta / On demand**

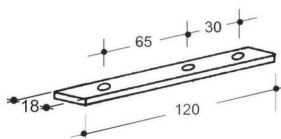
Art. 31-00028/C Kit cerniera TIR alta zincata / *Kit galv.heavy TIR hinge*

Art. 31-00009
Cerniera per TIR grande int.16 - D.16
Heavy TIR hinge int.16 - D.16
(Kg.0,400)

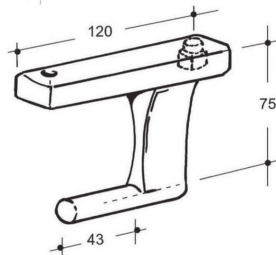
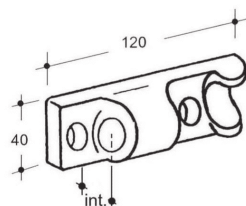

Art. 31-00003
Piastrina a 3 fori zinc.int.30+65
Galv. Back plate Int.30+65
(Kg.0,093)

Art. 31-00028
Perno per cern.TIR alta zinc.D.15
Galv.heavy TIR pin high D.15
(Kg.0,543)

Art. 31-00074
Brugola zincata D.8MA x 16
Galvanized screw D.8MA x 16
(Kg.0,010) **A richiesta / On demand**

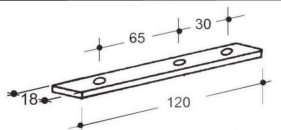
Art. 31-00016/C Kit cerniera cavalletto zincata / *kit galvanized hinge*

Art. 31-00003
Piastrina a 3 fori zinc.int.30+65
Galv. Back plate Int.30+65
(Kg.0,093)

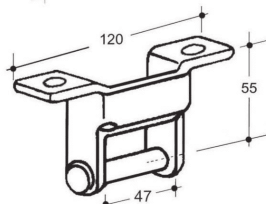

Art. 31-00016
Cerniera cavalletto zincata D.12
Galvanized hinge D.12
(Kg.0,253)

A richiesta / On demand

Art. 31-00075
Brugola zincata D.8MA x 18
Galv. screw D.8MA x 18
(Kg.0,011)



Art. 31-00017
Supporto cerniera cavalletto
Hook raw
(Kg.0,146)

Cerniere per sponde in alluminio da cassone fisso

Aluminium side board hinges for fixed load body

Art. 31-00150/C Kit cerniera L=88 inox

Kit Stainless steel hinge L=88

Art. 31-00150
Cerniera INOX L=88
Stainless steel hinge L=88
(Kg.0,304)

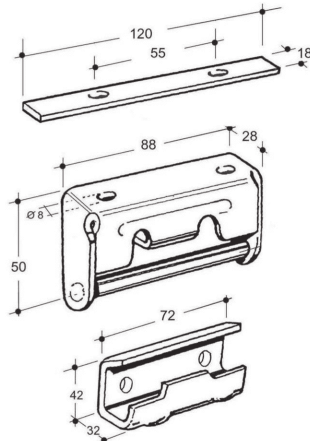

Art. 31-00152
Piastrina a 2 fori zinc.int. 55
Galvanized Back plate Int.55
(Kg.0,094)

Art. 31-00147
Supporto cerniera INOX
Stainless steel support
(Kg.0,198)

Art. 31-00150Z/C Kit cerniera L=92 zincata

Kit galvanized hinge L= 92

Art. 31-00150Z
Cerniera zincata L=92
Galv. hinge L=92
(Kg.0,304)

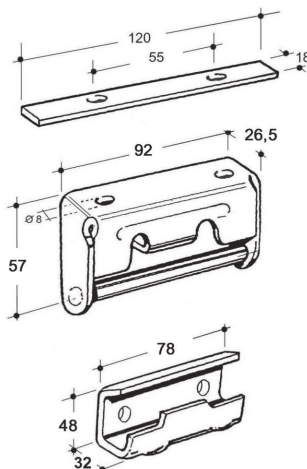

Art. 31-00152
Piastrina a 2 fori zinc.int. 55
Galvanized Back plate Int.55
(Kg.0,094)

Art. 31-00147Z
Supporto cerniera zincata
Galv. support
(Kg.0,205)

Art. 31-00151/C
Kit cern. S.A.I. senza rinforzo zinc. L=250

Kit galv. S.A.I. hinge L=250

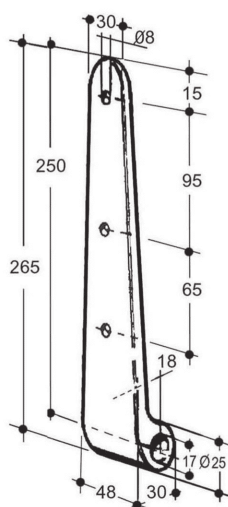

Art. 31-00151
Cerniera S.A.I. senza rinforzo zincata L=250
Galvanized S.A.I. hinge L=250
(Kg.0,705)

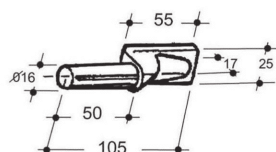

Art. 31-00149
Perno per cerniera S.A.I D16
Sideboard pin for SAI. hinge
(Kg.0,190)

Cerniere per sponde in alluminio a doppia aperturaAluminium side board hinges double opening

Art. 31-00035/C Kit cern. a doppia apertura "mignon zinc.mm.25

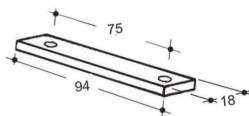
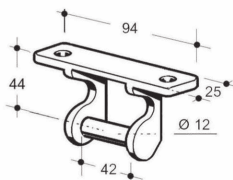
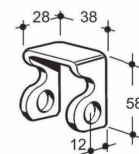
*Kit welded aluminium side board light hinge galv.25.mm***Art. 31-00038**Piastrina a 2 fori zinc.int. 75
Galv. Back plate Int.75
(Kg.0,076)**A richiesta / On demand****Art. 31-00075** (Kg.0,011)
Bruola zincata D.8MA x 18
Galv. screw D.8MA x 18**Art. 31-00037** (Kg.0,052)
Paletta per cern. foro D.16
Light raw locking plate
(hole D.16)**Art. 31-00035** (Kg.0,275)
Cern.doppia apertura zinc.
mignon mm.25
*Welded aluminium side
board light hinge galv.25mm***Art. 31-00036** (Kg.0,052)
Supporto cerniera (foro D.16)
Light raw support (hole D.16)

Art. 31-00040/C Kit cern. a doppia apertura zinc.mm.25

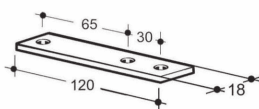
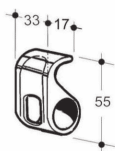
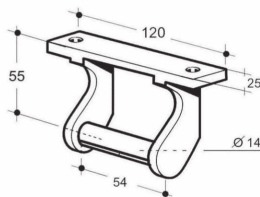
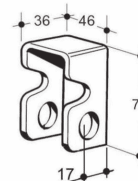
*Kit welded aluminium side board heavy hinge galvanized 25 mm m***Art. 31-00003**Piastrina a 3 fori zinc.int. 30+65
Galv.back plate Int.30+65
(Kg.0,093)**A richiesta / On demand****Art. 31-00075** (Kg.0,011)
Bruola zincata D.8MA x 18
Galv. screw D.8MA x 18**Art. 31-00042/N** (Kg.0,143)
Paletta per cern. foro D.20
Heavy raw locking plate
(hole D.20)**Art. 31-00040** (Kg.0,375)
Cern.doppia apertura zinc.25mm.
*Welded aluminium side board
heavy hinge galv.25 mm***Art. 31-00041** (Kg.0,180)
Supporto cerniera foro D.21
Heavy raw support hole D.21

Cerniere per sponde in alluminio a doppia apertura

Aluminium side board hinges double opening

Art. 31-00043/C Kit cerniera doppia apertura zinc.30mm. / Kit aluminium side board galv.30mm

Art. 31-00044

Piastrina a 3 fori c/foro centrale D.12 zinc.
Galv.back plate
(Kg.0,088)

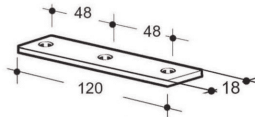

A richiesta / On demand

Art. 31-00075

Bruola zincata D.8MA x 18
Galv. screw D.8MA x 18
(Kg.0,011)



Art. 31-00042/N (Kg.0,143)
Paletta per cern. foro D.20
Heavy raw locking plate
(hole D.20)

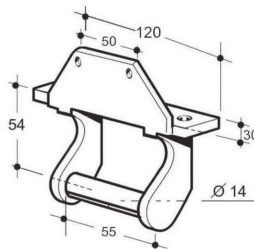

Art. 31-00043 (Kg.0,580)
Cern.doppia apertura zinc.mm.30
Aluminium side board galv.
hinge 30 mm

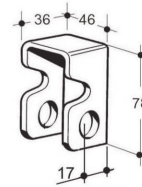

Art. 31-00041
Supporto cerniera foro D.21
Heavy raw support hole D.21
(Kg.0,180)

Cerniere per sponde in alluminio a doppia aperturaAluminium side board hinges double opening

Art. 31-00045/C Kit cerniera ribaltabile H.262 zincata / Kit galv. high hinge for dump trucks H.262

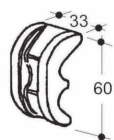

Art. 31-00042
Paletta per cerniera
Raw locking plate
(Kg.0,100)

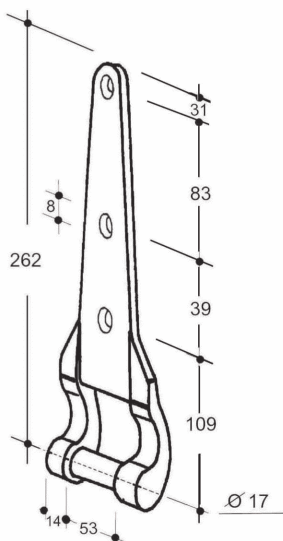

Art. 31-00045
Cern.ribaltabile alta zinc.H.262
Galv.high hinge for dump trucks H.262
(Kg.0,765)

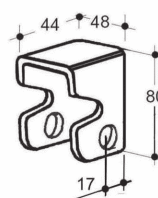

Art. 31-00046
Supporto cern. (foro D.21)
Raw support (hole D.21)
(Kg.0,244)

Art.31-00155/C Kit cern.ribaltabile alta zinc.H.372 / Galv.high hinge for dump trucks H.372

A richiesta / On demand

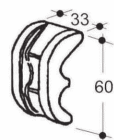

Art. 31-00042
Paletta per cerniera
Raw locking plate
(Kg.0,100)

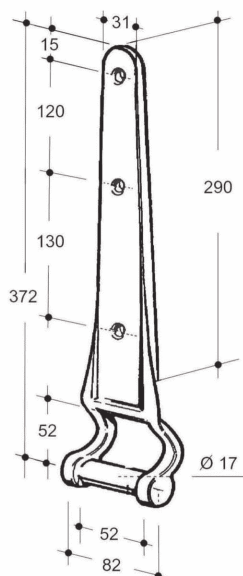

Art. 31-00155
Cerniera ribaltabile alta zinc.H.372
Galv.high hinge for dump trucks H.372
(Kg.1,075)

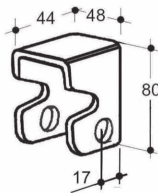

Art. 31-00046
Supporto cern. (foro D.21)
Raw support (hole D.21)
(Kg.0,244)

Cerniere per sponde in alluminio a doppia apertura

Aluminium side board hinges double opening

Art. 31-00161/C Kit cerniera ribaltabile zinc.H.1190 / Kit galv.hinge for dump trucks H.1190

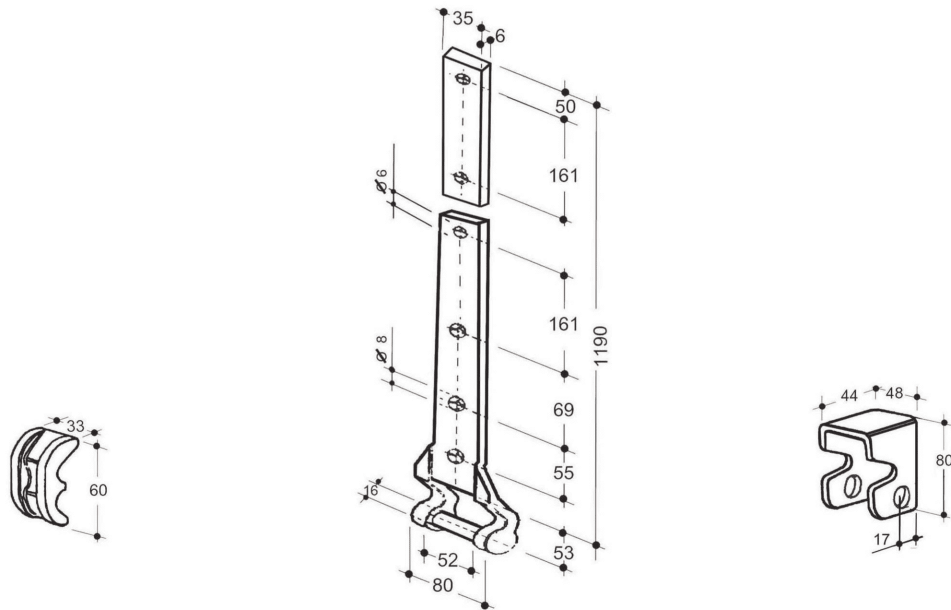

Art. 31-00042 (Kg.0,100)
Paletta per cerniera
Raw locking plate

Art. 31-00161
Cerniera ribaltabile zinc.H.1190
Galv.hinge for dump trucks H.1190
(Kg.2,000)

Art. 31-00046 (Kg.0,244)
Supporto cern. (foro D.21)
Raw support (hole D.21)

Art. 31-00162/C Kit cerniera ribaltabile zinc.H.790 / Kit galv.hinge for dump trucks H.790

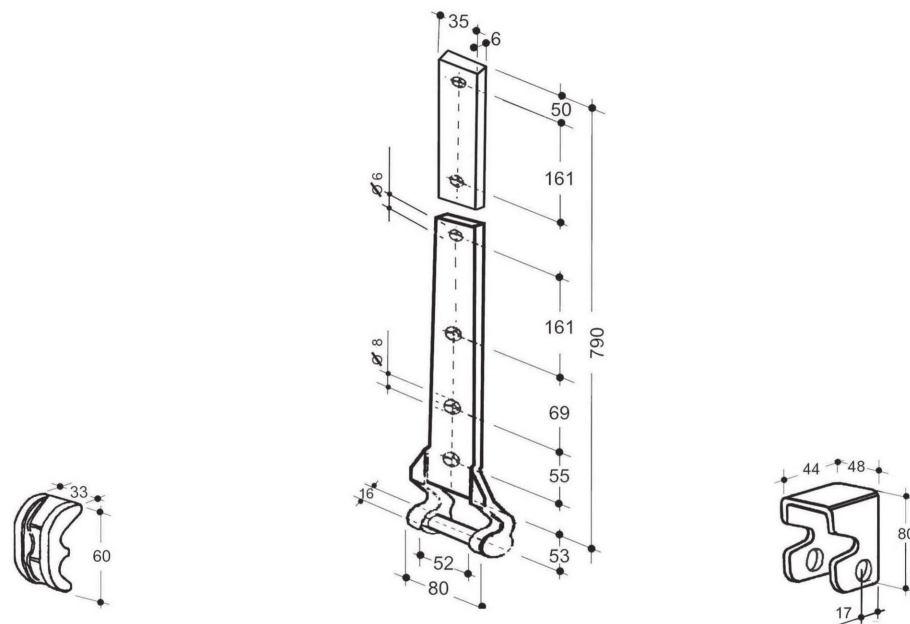

Art. 31-00042 (Kg.0,100)
Paletta per cerniera
Raw locking plate

Art. 31-00162
Cerniera ribaltabile zinc.H.790
Galv.hinge for dump trucks H.790
(Kg.1,500)

Art. 31-00046 (Kg.0,244)
Supporto cern. (foro D.21)
Raw support (hole D.21)

Cerniere per sponde in alluminio a doppia aperturaAluminium side board hinges double opening**Art. 31-00163/C** Supporto asta tipo RAO / *Raw support for hook paddle RAO type***Art. 31-00163**

Supporto asta tipo RAO foro D.21
Raw support for hook paddle RAO type hole D.21
 (Kg.0,150)

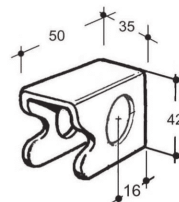
**Art. 31-00164**

Paletta per supporto asta
Raw hook paddle RAO type
 (Kg.0,052)

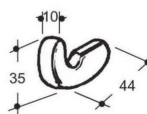
**Art. 31-00165/C** Supporto asta tipo RAO inox / *Stainless steel support RAO type***Art. 31-00165**

Supporto asta tipo RAO inox foro D.21
Stainless steel support RAO type hole D.21
 (Kg.0,120)

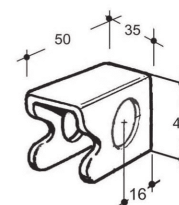
**Art. 31-00166**

Paletta per supporto asta inox
Stainless steel locking plate RAO type
 (Kg.0,052)

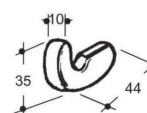
**Art. 31-00167/C** Supporto asta tipo RE-ALL / *Raw support for hook paddle RE-ALL type***Art. 31-00167**

Supporto asta tipo RE-ALL foro D.19
Raw support for hook paddle RE-ALL type hole D.19
 (Kg.0,240)

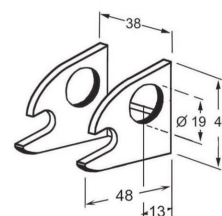
**Art. 31-00168**

Paletta per supporto asta tipo RE-ALL
Raw hook paddle RE-ALL type
 (Kg.0,140)

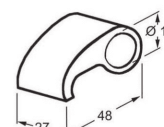

Piastrine

Back plate

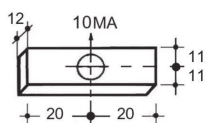

Art. 31-00039

(Kg.0,032)

Piastrina alluminio 1 foro D.10MA
Aluminium back plate with one hole D.10ma

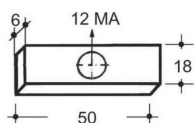

Art. 31-00049

(Kg.0,040)

Piastrina zinc.1foro D.12MA
Galv.back plate with one hole D.12MA

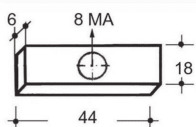

Art. 31-00051

(Kg.0,032)

Piastrina zinc.1foro D.8MA per paracicli 100x30
Galv.back plate with one hole D.8MA

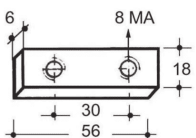

Art. 31-00048

(Kg.0,036)

Piastrina zinc.2fori int.30mm. per tasch. registrab.
Galv.back plate with 2 holes int.30mm for strike adjustable

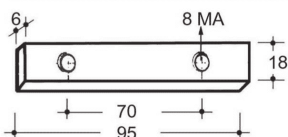

Art. 31-00007

(Kg.0,076)

Piastrina zinc.2fori int.70mm
Galv.back plate with 2 holes int.70mm

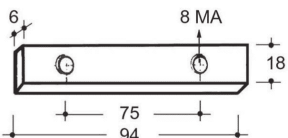

Art. 31-00038

(Kg.0,076)

Piastrina zinc.2fori int.75mm
Galv.back plate with 2 holes int.75 mm

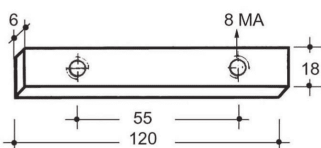

Art. 31-00152

(Kg.0,094)

Piastrina zinc.2fori int.55mm.
Galv.back plate with 2 holes int.55mm.

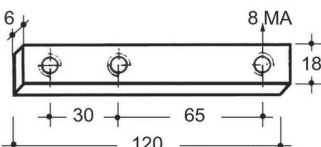

Art. 31-00003

(Kg.0,093)

Piastrina zinc.3fori int.30+65mm.
Galv.back plate with 3 hole int.30+65mm.

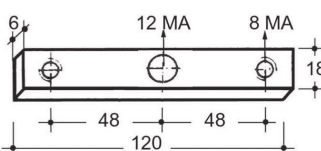

Art. 31-00044

(Kg.0,088)

Piastrina zinc.3fori int.48+48 c/foro centr.D.12MA
Galvanized back plate with one central hole D.12MA - int.48+48mm

Aste filettate

Tie rod thread

Art.	Aste filettate / Tie Rod thread	D.	L=	Kg.
31-00055	Asta filettata Raw tie rod	12 MA	400	0,280
31-00056	Asta filettata zinc. Galv. tie rod	12 MA	400	0,280
31-00057	Asta filettata Raw tie rod	12 MA	500	0,350
31-00058	Asta filettata zinc. Galv. tie rod	12 MA	500	0,350
31-00059	Asta filettata Raw tie rod	12 MA	600	0,420
31-00060	Asta filettata zinc. Galv. tie rod	12 MA	600	0,420
31-00061	Asta filettata Raw tie rod	12 MA	800	0,560
31-00062	Asta filettata zinc. Galv. tie rod	12 MA	800	0,560
31-00067	Asta filettata Raw tie rod	12 MA	900	0,630
31-00068	Asta filettata zinc. Galv. tie rod	12 MA	900	0,630
31-00063	Asta filettata Raw tie rod	12 MA	1000	0,700
31-00064	Asta filettata zinc. Galv. tie rod	12 MA	1000	0,700
31-00069	Asta filettata Raw tie rod	12 MA	1100	0,770
31-00069Z	Asta filettata zinc. Galv. tie rod	12 MA	1100	0,770
31-00065	Asta filettata Raw tie rod	12 MA	1200	0,840
31-00066	Asta filettata zinc. Galv. tie rod	12 MA	1200	0,840

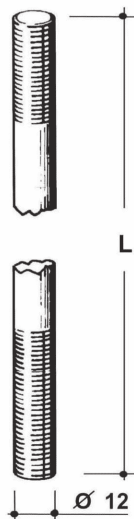

Distanziali e Dadi per aste filettate /

Bushes and Nut for Tie rod thread

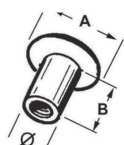

ART.	Distanziali / Bushes	A	B	Ø	kg.
31-00072	Alluminio filettato S/25 Aluminium S/25	20	22,5	13	0,008
31-00073	Alluminio filettato S/30 Aluminium S/30	20	27,5	13	0,009
31-00072Z	FE / ZINC. filettato S/25 Galvanized S/25	25	22,5	13	0,024



Art. 31-00070

(Kg.0,042)

Dado esagonale zinc.D.12MA per asta filettata
Galv.hexagonal nut D.12MA for tie rod



Art. 31-00071

(Kg.0,042)

Dado svasato/zinc.D.12MA per asta filettata
Galv.nut D.12 for tie rod



Art. 31-00071/F

(Kg.0,042)

Dado svasato/fresato zinc. D.12MA per asta filettata
Galvanized nut D.12 for tie rod

Accessoristica

Accessories

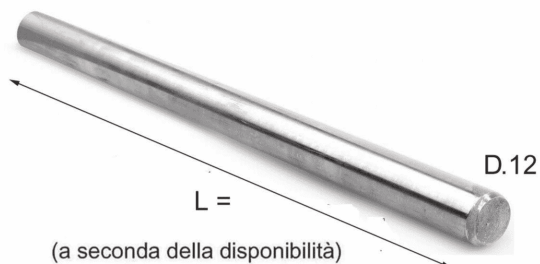

Art. 31-00011 (Kg/ml. 2,670)
 Tondino inox trafilato L=3000 o L=4000 D.12
 Full-drawn steel round bar L=3000 / L=4000 D.12

Art. 31-00051/C	Art.	Kit ancoraggio paracicli composto da : / Kit includes :	
	31-00051	Piastrina zincata 1 foro D.8	/ Galv.back with one hole D.8
	31-00079	Rondella piana D.8x16	/ Washer D.8x16
	31-00085	Vite a T bombata con cava D.8x14	/ hexagon socket button head D.8x14
	31-00086	Rondella dentellata D.8x14	/ Washer D.8x14

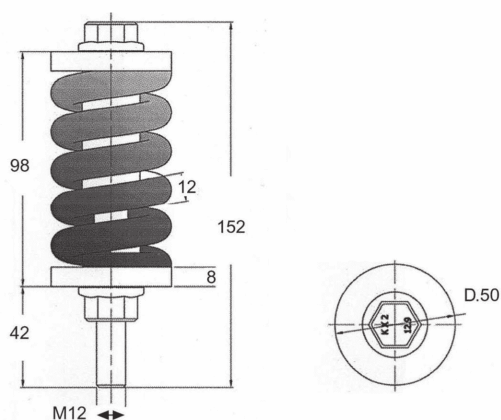

Art. 31-00050 (Kg.1,080)
 Sistema di fissaggio elastico
 Elastic fixing system

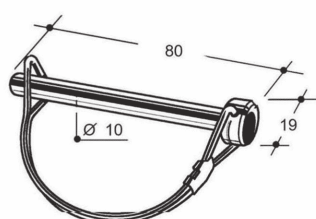

Art. 31-00094 (Kg.0,073)
 Spina per motozappa D.10
 Locking pin D.10

Brugole

Screw

Art.	Brugole zincate	Galvanized Screw	Dim.	Kg.
	31-00082		Ø 8 x 10	0,010
	31-00082/T	trattate / Treated	Ø 8 x 10	0,010
	31-00125		Ø 8 x 14	0,010
	31-00074		Ø 8 x 16	0,010
	31-00074/T	trattate / Treated	Ø 8 x 16	0,010
	31-00075		Ø 8 x 18	0,011
	31-00087/T	trattate / Treated	Ø 8 x 30	0,018
	31-00126/T	trattate / Treated	Ø 10 x 20	0,012

Dadi autobloccanti

Self-locking nut

	Dadi autobloccanti zincati	Galvanized self-locking nut	Dim.	Kg.	
	31-00078		8 MA	0,010	
	31-00084		4 MA	0,005	
	31-00054	per cavallotto piccolo (33-00096) / for lashing ring (33-00096)		10 MA x 1,50	0,010
	31-00093	per cavallotto inox (33-00095) / for S.S. lashing ring (33-00095)		12 MA x 1,25	0,010
	31-00047	per cavallotto (33-00094) / for lashing ring (33-00094)		12 MA x 1,75	0,010

Coppiglie

Cotter pins

Art.	Coppiglie	Cotter pins	Dim.	Kg.
	31-00090	Mout	Ø 3	0,010
	31-00091	Mout	Ø 4	0,020
	31-00092	Mout	Ø 5	0,035

Spine elastiche

Spring locking pins

Art.	Spine elastiche	Spring locking pins	Dim.	Kg.
	31-00095	L=30	Ø 3	0,002
	31-00105	L=25	Ø 5	0,002
	31-00096	L=30	Ø 5	0,003
	31-00097	L=30	Ø 6	0,004

Viti

Screw

	Viti testa	Screw head	Dim.	Kg.	
	31-00076/14	svasata	countersunk	Ø 8 x 14	0,008
	31-00076/50	svasata	countersunk	Ø 8 x 50	0,020
	31-00076	svasata	countersunk	Ø 8 x 25	0,010
	31-00077	svasata	countersunk	Ø 8 x 22	0,010

	Viti testa	Screw head	Dim.	Kg.	
	31-00120	esagonale c/dado autobloc.	hexagon with self-lock D.5MA	Ø 5 x 40	0,010
				Ø 5 x 40	0,010
	31-00083	esagonale	hexagon	Ø 8 x 14	0,008
	31-00099	esagonale	hexagon	Ø 8 x 20	0,010
	31-00283	esagonale	hexagon	Ø 4 x 20	0,008

	Viti testa	Screw head	Dim.	Kg.	
	31-00085	bombata con cava esagonale	Hexagon socket button head	Ø 8 x 14	0,008
	31-00123	bombata con cava esagonale	Hexagon socket button head	Ø 4 x 12	0,004

	Viti testa	Screw head	Dim.	Kg.	
	31-00116	trilobata esagonale	hexagon	Ø 8 x 35	0,010

	Viti	Screw	Kg.
	31-00117	Vite perno Laterale zincato per Mini 1 e 2	0,290
			Galvanized side screw bolt for Mini 1 e 2

	Viti	Screw	Kg.
	31-00053	Vite autofilettante D.5 x 14	0,004
			Self-tapping screw D.5 x 14

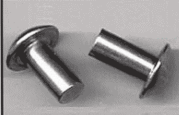
	Art. 31-00098 Ribattino in alluminio D.5- sottotesta 10mm.	Aluminium rivet D.5	(Kg.0,002)
---	--	---------------------	------------

Rondelle piane

Washer



Art. 31-00122

Rondella piana D.4 x 9 / Washer D. 4 x 9

(Kg.0,005)

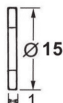

Art. 31-00121

Rondella piana D.5x15 / Washer D. 5 x 15

(Kg.0,005)

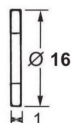

Art. 31-00079

Rondella piana D.8,5 x 16 / Washer D.8,5 x 16

(Kg.0,010)



Art. 31-00079/24

Rondella piana D. 8,5x24 / Washer 8,5x24

(Kg.0,013)



Art. 31-00079/10

Rondella piana D.10,5x20 / Washer 10,5 x 20

(Kg.0,013)

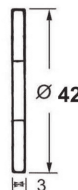

Art. 31-00080

Rondella piana D.14,5x42 / Washer d. 14,5

(Kg.0,028)

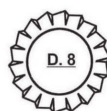

Art. 31-00086

Rondella dentellata D.8x14 / Washer D.8x14

(Kg.0,005)

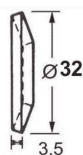

Art. 31-00081

Rondella a tazza D.14,5x32 / Washer d. 14,5

(Kg.0,015)

Cerniere e perni per sponde in ferro

Iron side board hinges and pins

Art. 31-00088/C Cerniera bombata leggera L=88 / Raw light hinge L=88

Art. 31-00088
Cerniera bombata leggera L=88
Raw light hinge L=88
(Kg.0,113)

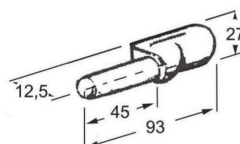
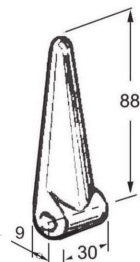

Art. 31-00089
Perno D.11
Raw pin D.11
(Kg.0,102)

Art. 31-00100/C Cerniera bombata media L=110 / Raw medium hinge L=110

Art. 31-00100
Cern. bombata media L= 110
Raw medium hinge L=110
(Kg.0,208)

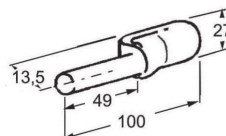
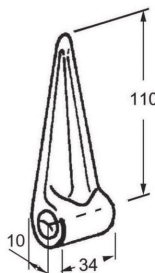

Art. 31-00101
Perno D.13
Raw pin D.13
(Kg.0,112)

Art. 31-00102/C Cern. bombata pesante L=124 / Raw heavy hinge L=124

Art. 31-00102
Cern. bombata pesante L=124
Raw heavy hinge L=124
(Kg.0,350)

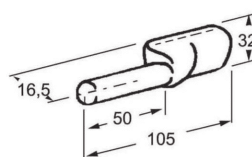
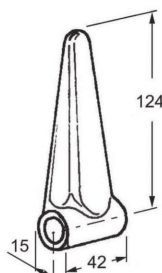

Art. 31-00103
Perno D.15
Raw pin D.15
(Kg.0,168)

Art. 31-00104/C Cerniera piatta leggera L= 94 / Raw light flat hinge L= 94

Art. 31-00104
Cern. piatta leggera L= 94
Raw light flat hinge L= 94
(Kg.0,158)

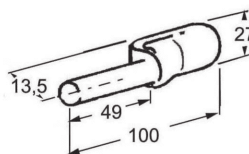
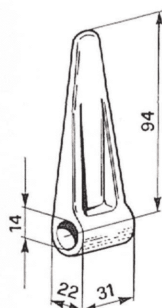

Art. 31-00101
Perno D.13
Raw pin D.13
(Kg.0,112)

Cerniere e perni per sponde in ferro

Iron side board hinges and pins

Art. 31-00106/C Cerniera piatta media L=190 / Raw medium flat hinge L=190

Art. 31-00106
Cern.piatta media L=190
Raw medium flat
hinge L=190
(Kg.0,610)

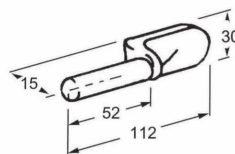
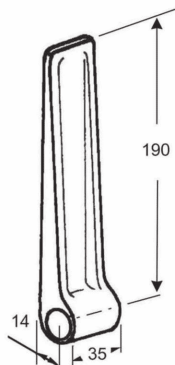

Art. 31-00107
Perno D.15 / Raw pin D.15
(Kg.0,280)

Art. 31-00108/C Cerniera tipo ROMA L=158 / Raw ROMA hinge L=158

Art. 31-00108
Cern.tipo ROMA L=158
Raw Roma hinge L=158
(Kg.0,453)

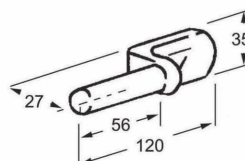
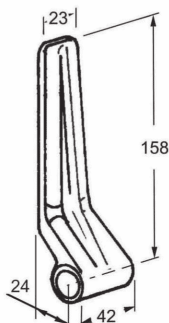

Art. 31-00109
Perno D.17 / Raw pin D.17
(Kg.0,283)

Art. 31-00110/C Cern. tipo SALERNO L=155 / Raw Salerno hinge L=155

Art. 31-00110
Cern.tipo SALERNO L=155
Raw Salerno hinge L=155
(Kg.0,391)

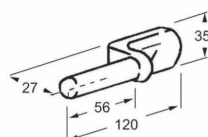
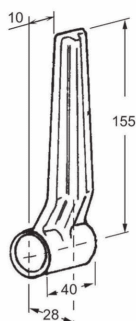

Art. 31-00109
Perno D.17 / Raw pin D.17
(Kg.0,283)

Art. 31-00132/C Kit cerniera curva L=170 / Kit curved hinge L=170

Art. 31-00132
Cerniera curva L=170
Curved hinge L=170
(Kg.0,638)

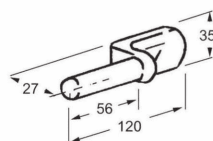
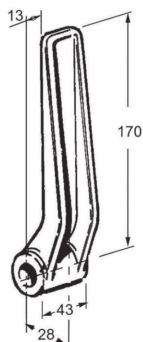

Art. 31-00109
Perno D.17 / Raw pin D.17
(Kg.0,283)

Cerniere e perni per sponde in ferro

Iron side board hinges and pins

Art. 31-00114/C Cern. con bordino pesante L=96 / Raw heavy hinge L=96

Art. 31-00114
Cern. con bordino pesante L=96
Raw heavy hinge L=96
(Kg.0,363)

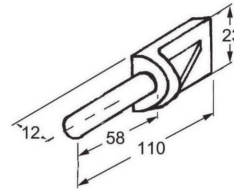
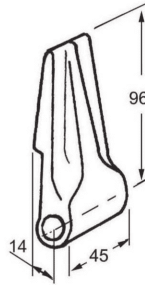

Art. 31-00115
Perno D.13 / Raw pin D.13
(Kg.0,147)

Art. 31-00133/C Kit cerniera a sgabello piccolo L=70 / Raw hinge L=70

Art. 31-00133
Cerniera a sgabello piccolo L=70
Raw hinge L=70
(Kg.0,208)

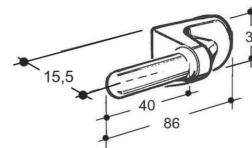
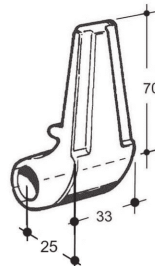

Art. 31-00134
Perno D.13 / Raw pin D.13
(Kg.0,154)

Art. 31-00195/C Kit cerniera a sgabello L=102 / Kit Raw hinge L=102

Art. 31-00109
Perno D.17
Raw pin D.17
(Kg.0,283)

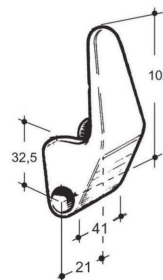
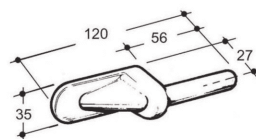

Art. 31-00195
Cerniera a sgabello L=102
Raw hinge L=102
(Kg.0,425)

Cerniere e perni per sponde in ferro

Iron side board hinges and pins

Art. 31-00111/C Kit cerniera L=200 / Kit Hinge L=200

Art. 31-00111
Cern.L=200
Hinge L=200
(Kg.0,648)

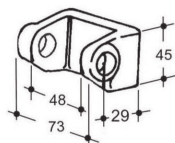
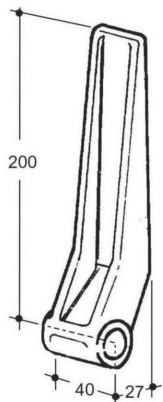

Art. 31-00112
Supporto cerniera
Raw support
(Kg.0,267)

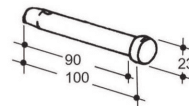

Art. 31-00113F
Spinotto forato D.16
Raw locking pin with hole

Art. 31-00113FZ
Spinotto forato zinc.D.16
Galv. locking pin with hole
(Kg.0,151)
(A RICHIESTA / ON DEMAND)

Art. 31-00118/C Kit Maniglia stopped / Raw stopped handle

Art. 31-00118
Maniglia stopped
Raw stopped handle
(Kg.0,240)

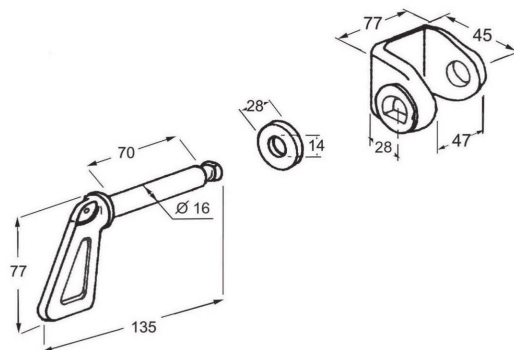

Art. 31-00119
Supp.maniglia + rondella
Raw support + washer
(Kg.0,296)

Art. 31-00118/CZ Kit maniglia stopped zincata / Galv. raw stopped handle

Art. 31-00118Z
Maniglia stopped zincata
Galv. Raw stopped handle
(Kg.0,240)

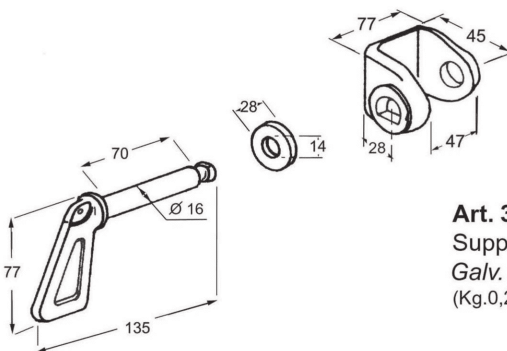

Art. 31-00119Z
Supp.maniglia + rondella zinc.
Galv. Raw support + washer
(Kg.0,296)

Cerniere per sponde in ferro a doppia apertura

Iron side board hinges double opening

Art. 31-00180/C Kit cerniera doppia apertura L=110 / Kit double opening light hinge L=110



Art. 31-00042
Paletta per cerniera
Raw locking plate
(Kg.0,100)

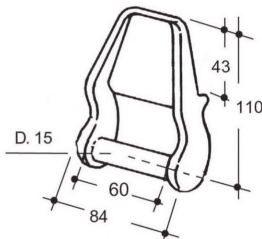

Art. 31-00180
Cern.doppia apert. piccola L=110
Double opening light hinge L=110
(Kg.0,550)

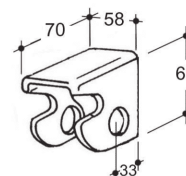

Art. 31-00181
Supporto cerniera foro D.23
Hinge support hole D.23
(Kg.0,480)

Art. 31-00183/C Kit cerniera doppia apertura grande L=167 / Kit double opening heavy hinge L=167

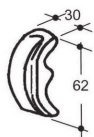

Art. 31-00185
Paletta per cerniera
Raw locking plate
(Kg.0,198)

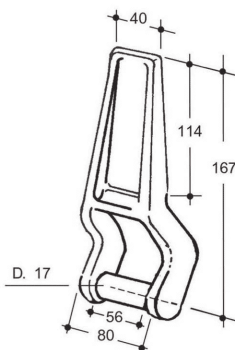

Art. 31-00183
Cern.doppia apertura grande L=167
Double opening heavy hinge L=167
(Kg.0,925)

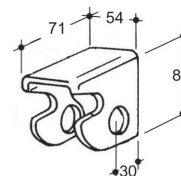

Art. 31-00184
Supporto cerniera foro D.23
Hinge support hole D.23
(Kg.0,480)

Art. 31-00186/C Kit cern. doppia apertura L=144 / Kit double opening hinge L=144

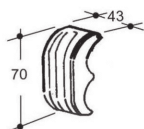

Art. 31-00188
Paletta per cerniera
Raw locking plate
(Kg.0,246)

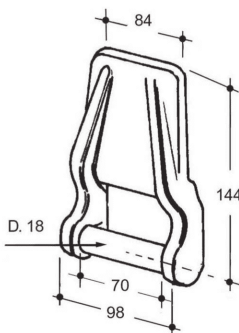

Art. 31-00186
Cern. doppia apertura L=144
Double opening hinge L=144
(Kg.1,118)

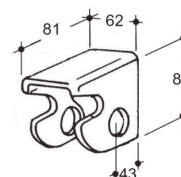

Art. 31-00187
Supporto cerniera foro D.26
Hinge support hole D.26
(Kg.0,597)

Cerniere per sponde in ferro a doppia apertura

Iron side board hinges double opening

Art. 31-00189/C Kit cern.posteriore Dx L=112 / *Kit rear right hinge L=112*
 Art. 31-00190/C Kit cern.posteriore Sx L=112 / *Kit rear left hinge L=112*

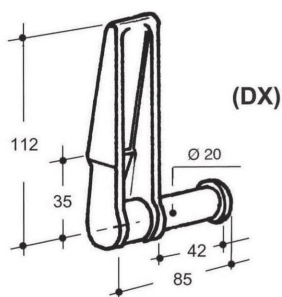

Art. 31-00189
 Cerniera posteriore Dx L=112
Rear right hinge L=112
 (Kg.0,515)

Art. 31-00190
 Cerniera posteriore SX L=112
Rear left hinge L=112
 (Kg.0,515)

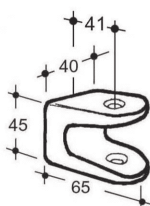

Art. 31-00191
 Supporto cerniera
Hinge support
 (Kg.0,392)

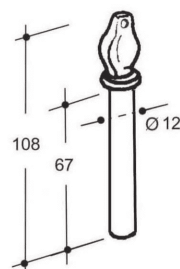

Art. 31-00192
 Spinotto D.12
Raw locking pin D.12
 (Kg.0,108)

Art. 31-00197/C Kit cerniera post. Dx. piccola L=70 / *Kit rear light right hinge L=70*
 Art. 31-00198/C Kit cerniera post. Sx. piccola L=70 / *Kit rear light left hinge L=70*

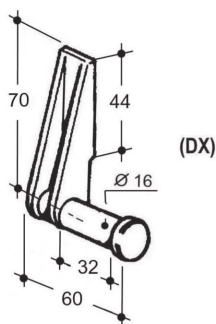

Art. 31-00197
 Cern.posteriore Dx piccola L=70
Rear light right hinge L=70
 (Kg.0,195)

Art. 31-00198
 Cern.posteriore Sx piccola L=70
Rear light left hinge L=70
 (Kg.0,195)

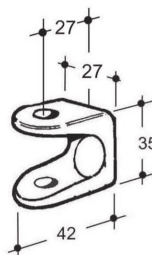

Art. 31-00199
 Supporto cerniera
Hinge support
 (Kg.0,134)

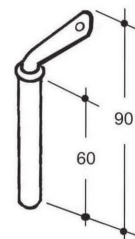

Art. 31-00205
 Spina stampata D.9
Pin D.9
 (Kg.0,108)

Art. 31-00200
 Spina tornita D.9
Pin D.9
 (Kg.0,108)
(A richiesta / On demand)

Cerniere per apertura a libro

Rear door hinge

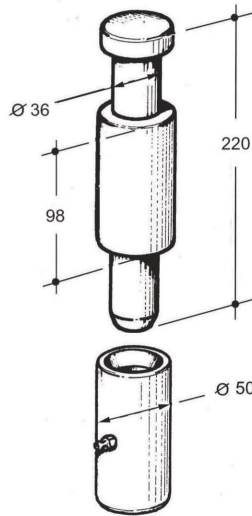

Art. 31-00201 (Kg.3,200)
 Cerniera per apertura a libro D.36 inferiore
 Rear door hinge - Down hinge

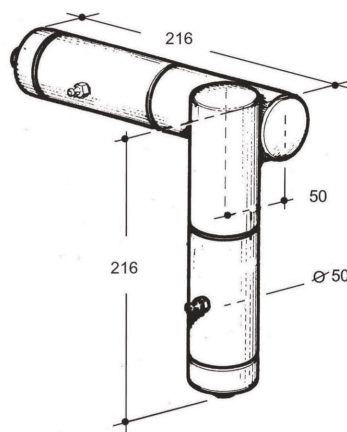

Art. 31-00202 (Kg.6,590)
 Cerniera per apertura a libro D.36 superiore
 Rear door hinge - Upper hinge

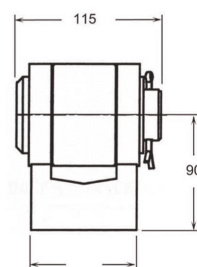
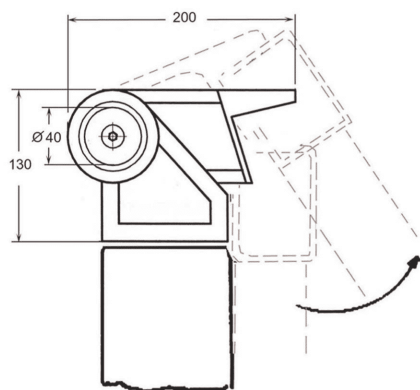
Kit cern. per ribaltabili pesantiKit heavy raw catches high door locks

(Kg.8,500)

Art. 31-00210 Kit cern. per ribaltabili pesanti *Kit heavy raw catches high door locks*

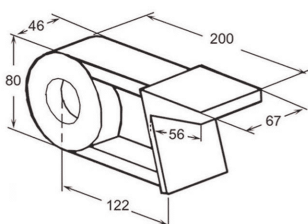

Art. 31-00210/1 (Kg.3,850)
Cerniera per ribaltabili pesanti
Raw heavy hinge

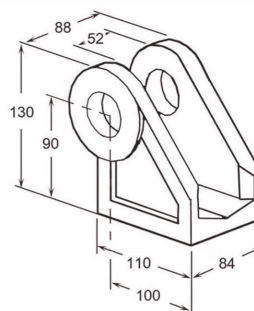

Art. 31-00210/2 (Kg.3,400)
Supporto cern. per ribaltabili pesanti
Raw heavy support

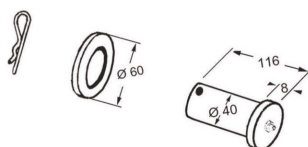

Art. 31-00210/4
Coppiglia D.6 e rondella D.60 per perno D.40
Cotter pin D. 6 and washer D.60 for pin D.40
(Kg.0,080)

Art. 31-00210/3
Perno D.40 per cern. ribaltabile pesante
Raw heavy pin D.40
(Kg.1,170)