

**Sfere e spinotti**

***Balls and pins***

**35**



**RE-ALL**

## Schema ribaltabile

## Folding scheme

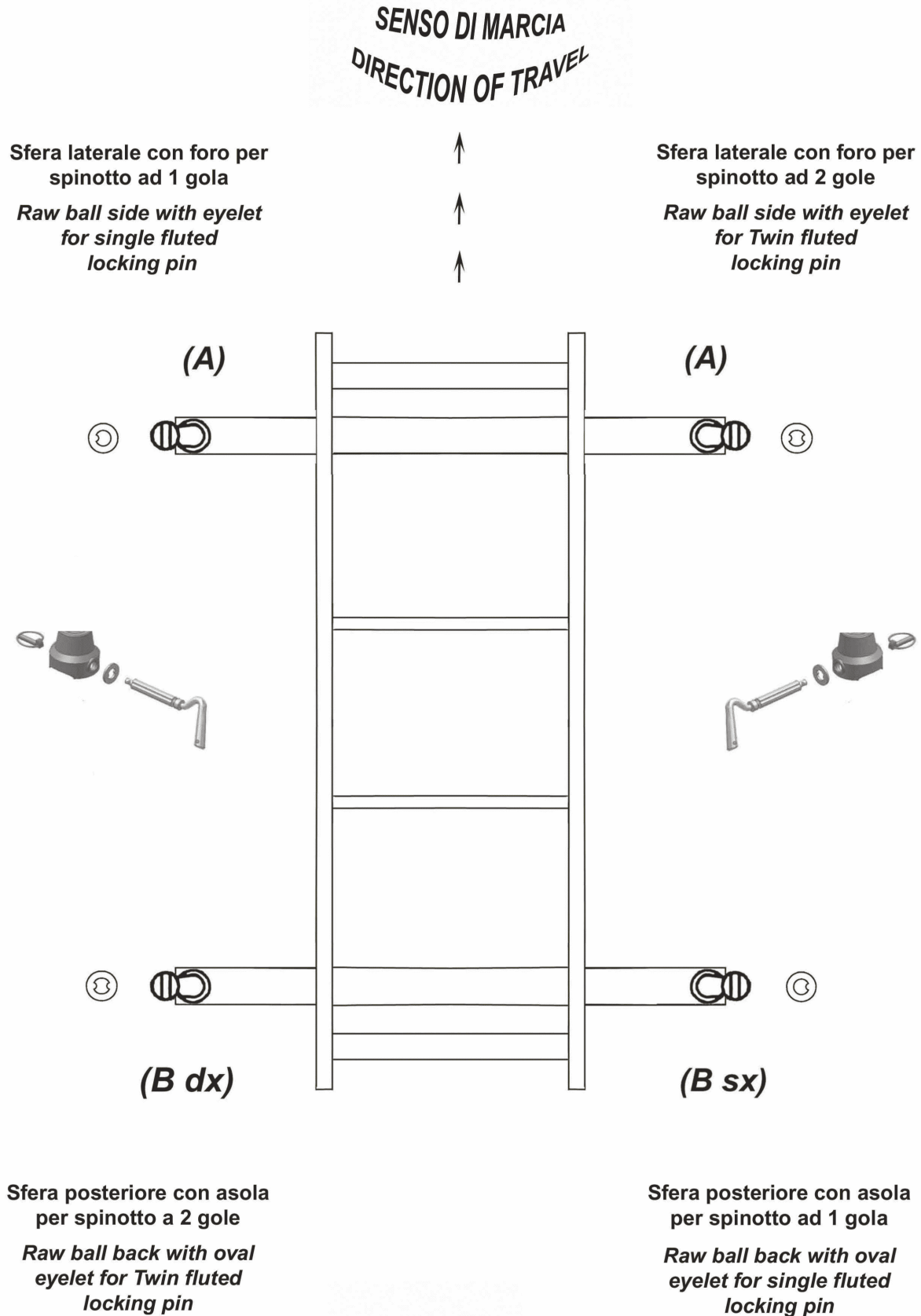

Art. 35-00000/M	
35-00000	4
35-00000/1	2
35-00000/2	2
35-00004	1
35-00005	2
35-00006	1
35-00007	2
35-00008	2

**KIT SFERE PER 1 VEICOLO D.60 AMBIDESTRA**  
**COMPLETE SET FOR VEHICLE D.60 AMBIDEXTROUS**

Portata Max Kg. 2000

Load cap.2000 kg. Max

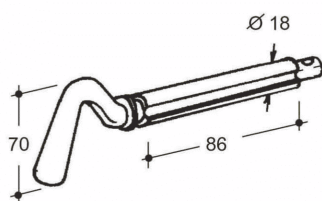

**Art. 35-00004**  
 Spinotto a 1 gola D.18  
*Single fluted locking pin D.18*  
 (Kg.0,301)

**Art. 35-00005**  
 Piastrina a 1 gola  
*Single fluted raw plate*  
 (Kg.0,017)

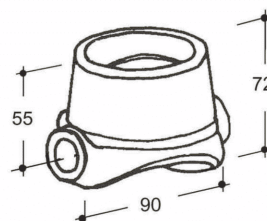

**Art. 35-00000**  
 Supporto a sfera D.60 forgiato  
*Raw socket for ball D.60 forged*  
 (Kg.1,290)

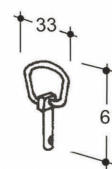

**Art. 35-00008**  
 Coppiglia D.4,5  
*Cotter pin D.4,5*  
 (Kg.0,007)

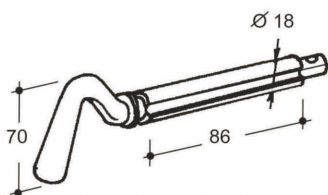

**Art. 35-00006**  
 Spinotto a 2 gole D.18  
*Twin fluted locking pin D.18*  
 (Kg.0,302)

**Art. 35-00007**  
 Piastrina a 2 gole  
*Twin fluted raw plate*  
 (Kg.0,017)

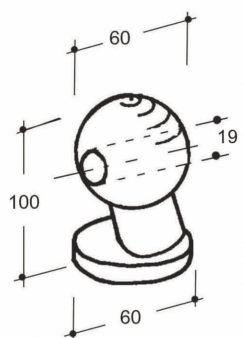

**Art. 35-00000/1**  
 Sfera con foro Ø60  
 forgiata  
*Raw ball Ø60  
 with eyelet forged*  
 (Kg.1,243)

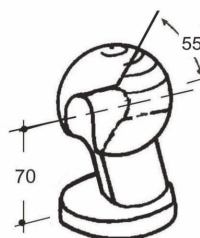

**Art. 35-00000/2**  
 Sfera con asola D.60  
 ambidestra  
*Raw ball D.60  
 with oval eyelet both side*  
 (Kg.1,122)

(A)

(B)

Art. 35-00001/M	
35-00001	4
35-00002	2
35-00003	1
35-00003/SX	1
35-00004	1
35-00005	2
35-00006	1
35-00007	2
35-00008	2

**KIT SFERE PER 1 VEICOLO D.60**  
**COMPLETE SET FOR VEHICLE D.60**

Portata Max Kg. 2000    Load cap.2000 kg. Max

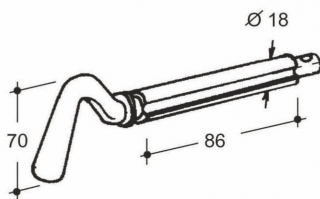

**Art. 35-00004**  
Spinotto a 1 gola D.18  
Single fluted locking pin D.18  
(Kg.0,301)

**Art. 35-00005**  
Piastrina a 1 gola  
Single fluted raw plate  
(Kg.0,017)

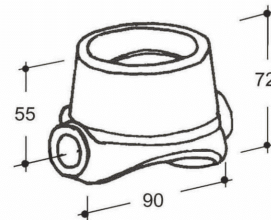

**Art. 35-00001**  
Supporto a sfera D.60  
Raw socket for ball D.60  
(Kg.1,290)

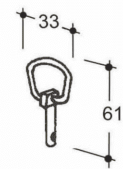

**Art. 35-00008**  
Coppiglia D.4,5  
Cotter pin D.4,5  
(Kg.0,007)

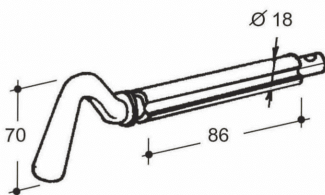

**Art. 35-00006**  
Spinotto a 2 gole D.18  
Twin fluted locking pin D.18  
(Kg.0,302)

**Art. 35-00007**  
Piastrina a 2 gole  
Twin fluted raw plate  
(Kg.0,017)

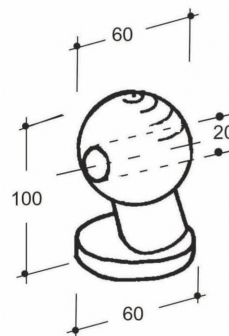

**Art. 35-00002**  
Sfera con foro Ø60  
Raw ball Ø60  
with eyelet  
(Kg.1,243)

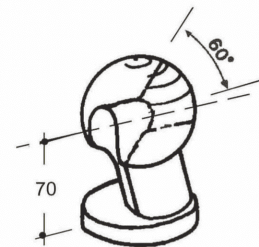

**Art. 35-00003**  
Sfera con asola DX D.60  
Raw ball D.60  
with oval eyelet - right  
(Kg.1,122)

**Art. 35-00003/SX**  
Sfera con asola SX D.60  
Raw ball D.60  
with oval eyelet - left

(A)

(B sx)

Art. 35-00009/M	
35-00009	4
35-00010	2
35-00011	1
35-00011/SX	1
35-00004/L	1
35-00005	2
35-00006/L	1
35-00007	2
35-00008	2

**KIT SFERE PER 1 VEICOLO D.75**  
**COMPLETE SET FOR VEHICLE D.75**

Portata Max Kg. 5000 Load cap. 5000 kg. Max

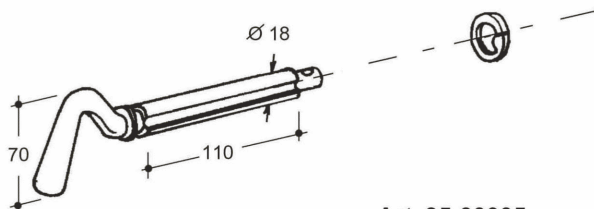

**Art. 35-00004/L**  
 Spinotto a 1 gola D.18  
 L=110  
 Single fluted locking pin  
 L=110 D.18  
 (Kg.0,380)

**Art. 35-00005**  
 Piastrina a 1 gola  
 Single fluted raw plate  
 (Kg.0,017)

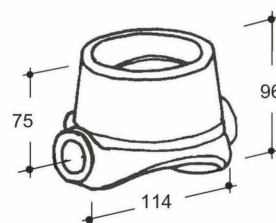

**Art. 35-00009**  
 Supporto a sfera D.75  
 Raw socket for ball D.75  
 (Kg.2,555)

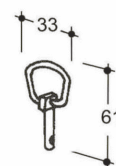

**Art. 35-00008**  
 Coppiglia D.4,5  
 Cotter pin D.4,5  
 (Kg.0,007)

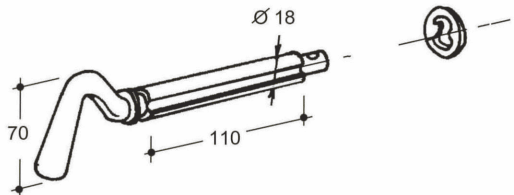

**Art. 35-00006/L**  
 Spinotto a 2 gole D.18  
 L=110  
 Twin fluted locking pin  
 L=110 D.18  
 (Kg.0,365)

**Art. 35-00007**  
 Piastrina a 2 gole  
 Twin fluted raw plate  
 (Kg.0,017)

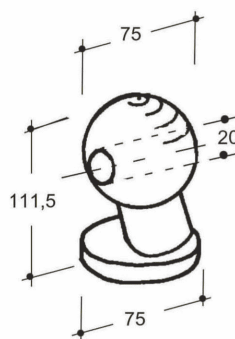

**Art. 35-00010**  
 Sfera con foro D.75  
 Raw ball D.75  
 with eyelet  
 (Kg.2,160)

(A)

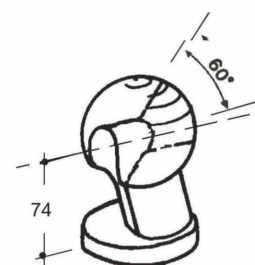

**Art. 35-00011**  
 Sfera con asola DX D.75  
 Raw ball D.75 with oval  
 eyelet - right  
 (Kg.1,900)

**Art. 35-00011/SX**  
 Sfera con asola SX D.75  
 Raw ball D.75 with oval  
 eyelet - left

(B sx)

Art. 35-00012/M	
35-00012	4
35-00013	2
35-00014	1
35-00014/SX	1
35-00015	1
35-00016	2
35-00017	1
35-00018	2
35-00019	2

**KIT SFERE PER 1 VEICOLO D.85**  
**COMPLETE SET FOR VEHICLE D.85**

Portata Max Kg. 15000 Load cap.15000 kg. Max

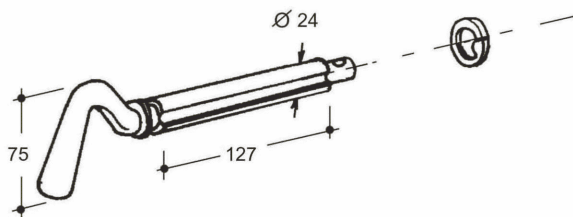

**Art. 35-00015**  
 Spinotto a 1 gola D.24  
 Single fluted locking pin D.24  
 (Kg.0,714)

**Art. 35-00016**  
 Piastrina a 1 gola  
 Single fluted raw plate  
 (Kg.0,026)

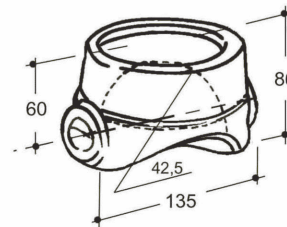

**Art. 35-00012**  
 Supporto a sfera D.85  
 Raw socket for ball D.85  
 (Kg.3,388)



**Art. 35-00019**  
 Coppiglia D.6  
 Cotter pin D.6  
 (Kg.0,019)

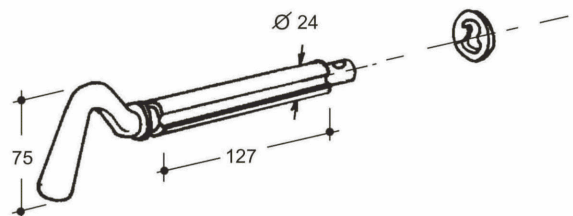

**Art. 35-00017**  
 Spinotto a 2 gole D.24  
 Twin fluted locking pin D.24  
 (Kg.0,670)

**Art. 35-00018**  
 Piastrina a 2 gole  
 Twin fluted raw plate  
 (Kg.0,026)

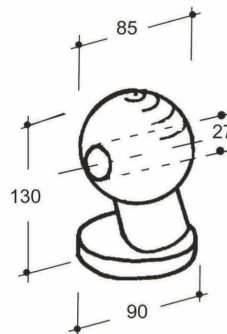

**Art. 35-00013**  
 Sfera con foro D.85  
 Raw ball D.85  
 with eyelet  
 (Kg.3,336)

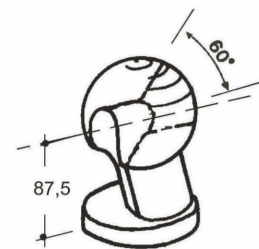

**Art. 35-00014**  
 Sfera con asola DX D.85  
 Raw ball D.85  
 with oval eyelet - right  
 (Kg.3,015)

**Art. 35-00014/SX**  
 Sfera con asola SX D.85  
 Raw ball D.85  
 with oval eyelet - left

(A)

(B sx)

Art. 35-00020/M	
35-00020	4
35-00021	2
35-00022	1
35-00022/SX	1
35-00023	1
35-00016	2
35-00024	1
35-00018	2
35-00019	2

**KIT SFERE PER 1 VEICOLO D.95**  
**COMPLETE SET FOR VEHICLE D.95**

Portata Max Kg. 25000 Load cap. 25000 kg. Max

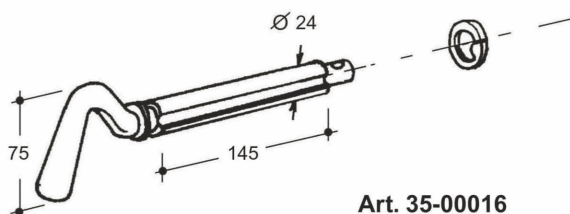

**Art. 35-00016**  
 Piastrina a 1 gola  
 Single fluted raw plate  
 (Kg.0,026)

**Art. 35-00023**  
 Spinotto a 1 gola D.24  
 Single fluted locking pin D.24  
 (Kg.0,782)

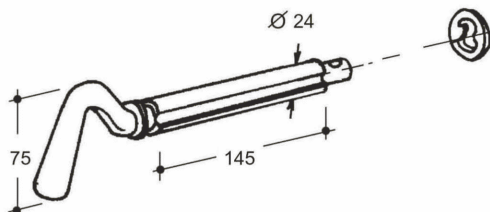

**Art. 35-00018**  
 Piastrina a 2 gole  
 Twin fluted raw plate  
 (Kg.0,026)

**Art. 35-00024**  
 Spinotto a 2 gole D.24  
 Twin fluted locking pin D.24  
 (Kg.0,762)

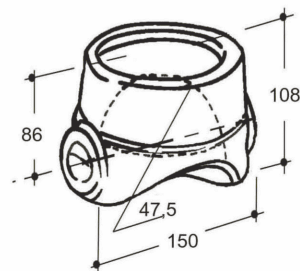

**Art. 35-00020**  
 Supporto a sfera D.95  
 Raw socket for ball D.95  
 (Kg.5,630)

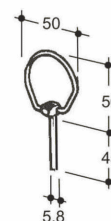

**Art. 35-00019**  
 Coppiglia D.6  
 Cotter pin D.6  
 (Kg.0,019)

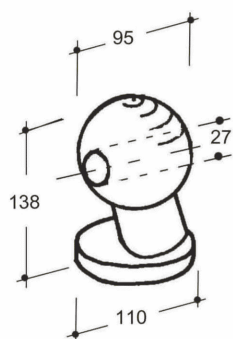

**Art. 35-00021**  
 Sfera con foro D.95  
 Raw ball D.95  
 with eyelet  
 (Kg.4,810)

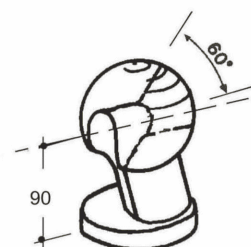

**Art. 35-00022**  
 Sfera con asola DX D.95  
 Raw ball D.95 with  
 oval eyelet - right  
 (Kg.4,630)

**Art. 35-00022/SX**  
 Sfera con asola SX D.95  
 Raw ball D.95 with  
 oval eyelet - left

(A)

(B sx)

Art. 35-00030/M	
35-00030	4
35-00031	2
35-00032	1
35-00032/SX	1
35-00033	1
35-00034	2
35-00035	1
35-00036	2
35-00019	2

**KIT SFERE PER 1 VEICOLO D.110**  
**COMPLETE SET FOR VEHICLE D.110**

Portata Max Kg. 45000 Load cap. 45000 kg. Max

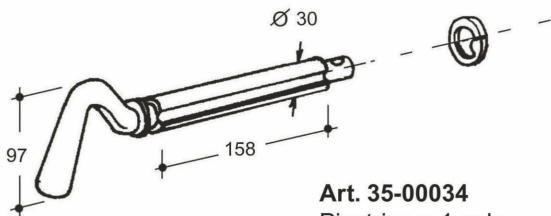

**Art. 35-00034**  
Piastrina a 1 gola  
Single fluted raw plate

**Art. 35-00033**  
Spinotto a 1 gola D.30  
Single fluted locking pin D.30  
(Kg.1,430)

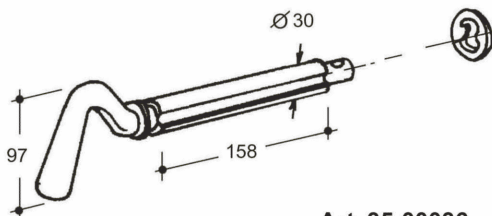

**Art. 35-00036**  
Piastrina a 2 gole  
Twin fluted raw plate

**Art. 35-00035**  
Spinotto a 2 gole D.30  
Twin fluted locking pin D.30  
(Kg.1,420)

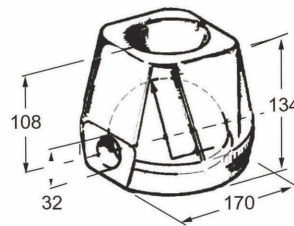

**Art. 35-00030**  
Supporto a sfera D.110  
Raw socket for ball D.110  
(Kg.9,210)

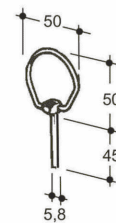

**Art. 35-00019**  
Coppiglia D.6  
Cotter pin d. 6  
(Kg.0,019)

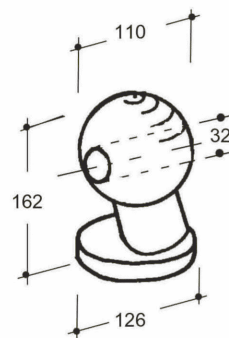

**Art. 35-00031**  
Sfera con foro D.110  
Raw ball D.110  
with eyelet  
(Kg.8,165)

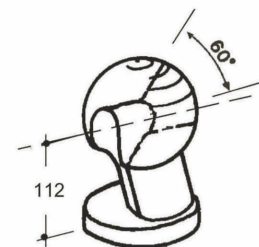

**Art. 35-00032**  
Sfera con asola DX D.110  
Raw ball d. 110 with  
oval eyelet - right  
(Kg.7,536)

**Art. 35-00032/SX**  
Sfera con asola SX Ø110  
Raw ball D.110 with  
oval eyelet - left

(A)

(B sx)

**KIT per ribaltabile con bocca di lupo e forcella con perno D.22**  
**Complete set three way tipper joint wolf's D.22**

Portata Max Kg. 5000

Load cap. 5000 kg. Max

Art. 35-00060/M

35-00064	1
35-00060	2
35-00068	1
35-00066	2
35-00062	4

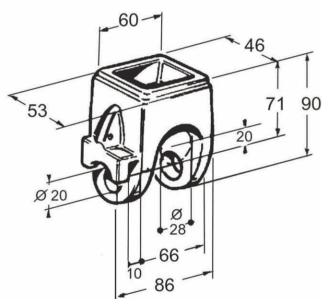

**Art. 35-00060**

Bocca di lupo "F. U." con foro D.20  
 Raw support wolf's with hole D.20

(Kg.1,370)

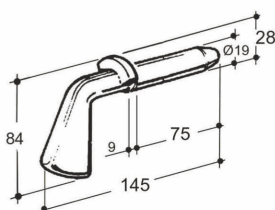

**Art. 35-00064**

Maniglia "F. U." perno D.19  
 Raw locking pin D.19

(Kg.0,350)

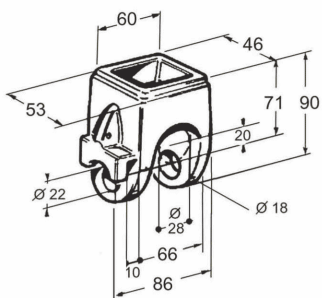

**Art. 35-00066**

Bocca di lupo "F. D." foro D.22 / D.18  
 Raw support wolf's with differentiated hole D.22/D.18

(Kg.1,357)

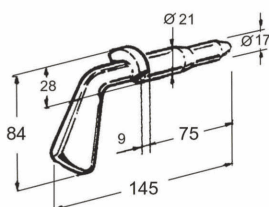

**Art. 35-00068**

Maniglia "F. D." perno D.21/D.17  
 Raw locking pin D.21/D.17

(Kg.0,403)

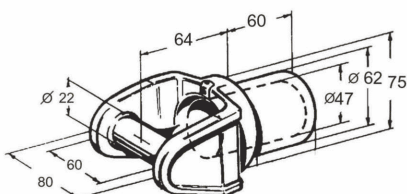

**Art. 35-00062**

Forcella per bocca di lupo perno D.22  
 Raw fork wolf's pin D.22

(Kg.1,585)

**KIT per ribaltabile con bocca di lupo e forcella con perno D.30**  
**Complete set three way tipper joint wolf's D.30**

Portata Max Kg. 10000

Load cap. 10000 kg. Max

Art. 35-00080/M	
35-00084	1
35-00080	2
35-00088	1
35-00086	2
35-00082	4

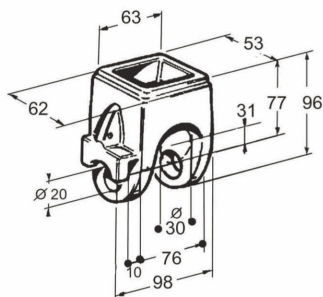

**Art. 35-00080**

Bocca di lupo "F. U." con foro D.20  
 Raw support wolf's with hole D.20

(Kg.1,933)

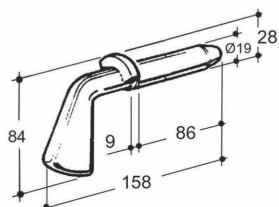

**Art. 35-00084**

Maniglia "F. U." perno D.19  
 Raw locking pin d. 19

(Kg.0,426)

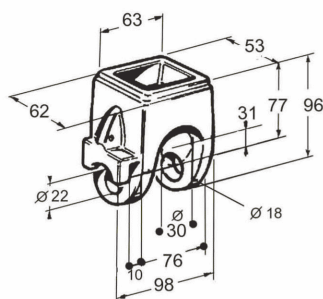

**Art. 35-00086**

Bocca di lupo "F.D."  
 con foro D.18/22  
 Raw support wolf's with  
 differentiated hole D.18/D.22

(Kg.1,868)

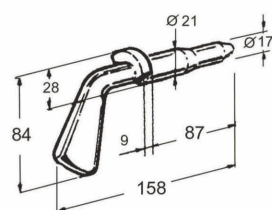

**Art. 35-00088**

Maniglia "F. D." perno D.17/D.21  
 Raw locking pin D.17/D.21

(Kg.0,438)

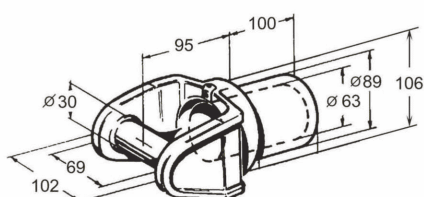

**Art. 35-00082**

Forcella per bocca di lupo perno D.30  
 Raw fork wolf's PIN D.30

(Kg.5,334)

Art. 35-00100/M	
35-00100	1
35-00100/SX	1
35-00102	1
35-00102/SX	1
35-00104	4
35-00106	1
35-00108	1
35-00109	4

**KIT SFERE PER 1 VEICOLO D.75 CON PIASTRA**  
**HORIZONTAL COMPLETE SET FOR VEHICLE D.75**

Portata Max Kg. 5000      Load cap. 5000 kg. Max

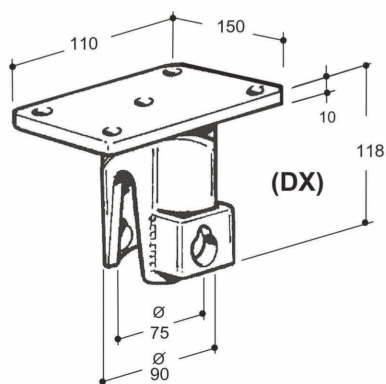

**Art. 35-00100**

Supp.sfera DX zinc.c/piastra - foro D.16,5 1  
 Galvanized right socket with hole D.16,5

**Art. 35-00100/SX**

Supp.sfera SX zinc.c/piastra - foro D.16,5 1  
 Galvanized left socket with hole D.16,5

**Art. 35-00102**

Supp.sfera DX zinc.c/piastra - foro D.18,5 / D.14,5  
 Galvanized right socket with hole D.18,5 / D.14,5

**Art. 35-00102/SX**

Supp.sfera SX zinc.c/piastra - foro D.18,5 / D.14,5  
 Galvanized left socket with hole D.18,5 / D.14,5

(Kg.1,500)

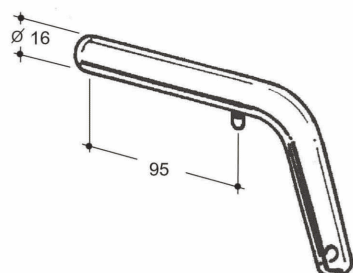

**Art. 35-00106**

Spinotto zinc. D.16  
 Galvanized locking pin D.16

(Kg.0,320)

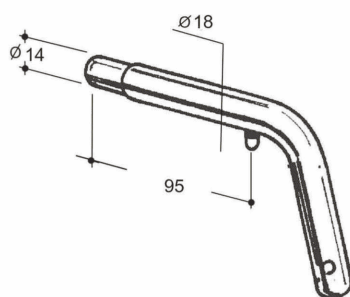

**Art. 35-00108**

Spinotto zinc.D.18 / D.Ø 14  
 Galv.locking pin D.18 / D.14

(Kg.0,330)

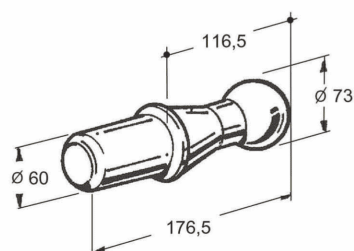

**Art. 35-00104**

Sfera D.73 / Raw ball D.73

(Kg.2,000)

Art. 35-00110/M	
35-00110	1
35-00110/SX	1
35-00112	1
35-00112/SX	1
35-00114	4
35-00116	1
35-00118	1
35-00119	4

**KIT SFERE PER 1 VEICOLO D.50 CON PIASTRA  
HORIZONTAL COMPLETE SET FOR VEHICLE D.50**

Portata Max Kg. 3500      Load cap. 3500 kg. Max

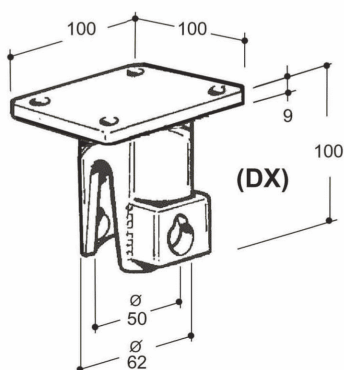

**Art. 35-00110**

Supp.sfera DX zinc.c/piastra-foro D.14,5  
Galvanized right socket with hole D.14,5

**Art. 35-00110/SX**

Supp.sfera SX zinc.c/piastra-foro D.14,5  
Galvanized left socket with hole D.14,5

**Art. 35-00112**

Supp.sfera DX zinc.c/piastra-foro D.16,5 / D.12,5  
Galvanized right socket with hole D.16,5 / D.12,5

**Art. 35-00112/SX**

Supp.sfera SX zinc.c/piastra-foro D.16,5 / D.12,5  
Galvanized left socket with hole D.16,5 / D.12,5  
(Kg.1,500)

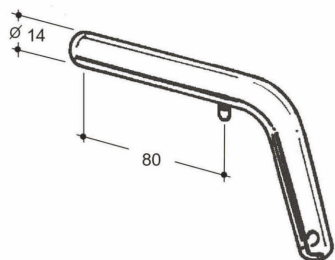

**Art. 35-00116**

Spinotto zinc. D.14  
Galv. locking pin D.14  
(Kg.0,300)

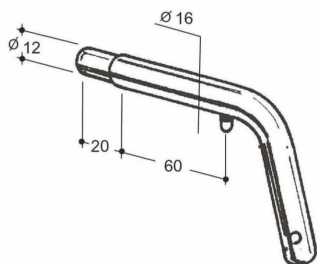

**Art. 35-00118**

Spinotto zinc. D.16 - D.12  
Galv.locking pin D.16 - D.12  
(Kg.0,310)

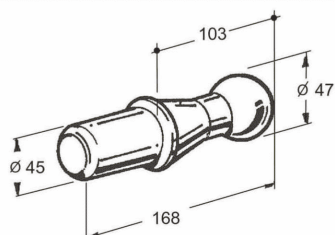

**Art. 35-00114**

Sfera D.47 / Raw ball D.47  
(Kg.0,920)

## Accessoristica

## Accessories

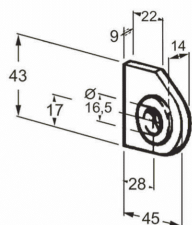
**Art. 35-00040**

Orecchietta tipo "P"/Raw ear type "P"

(Kg.0,098)

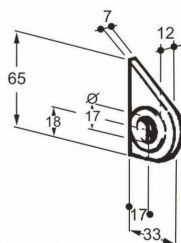
**Art. 35-00042**

Orecchietta tipo "M"/Raw ear type "M"

(Kg.0,082)

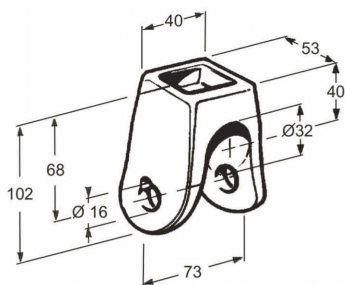
**Art. 35-00044**

Cavallotto ribaltabile

Raw forged support for tipper

(Kg.0,820)

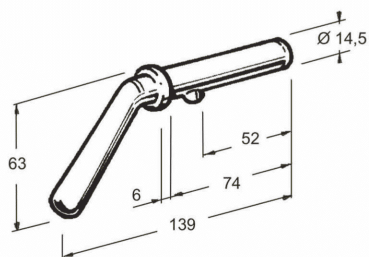
**Art. 35-00046**

Chiavistello cavallotto ribaltabile

Raw forged pin for tipper

(Kg.0,203)

## Accessoristica

## Accessories

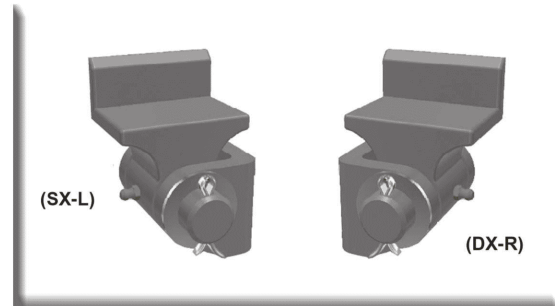
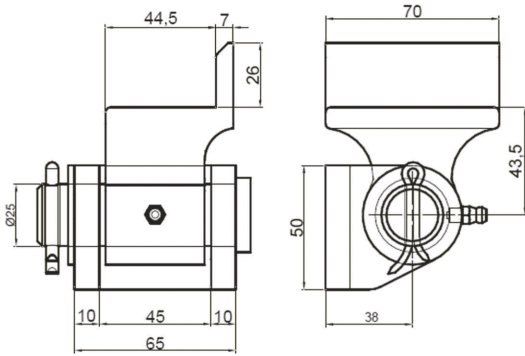

**Art. 35-00077/DX** Kit ribaltabile posteriore leggero grezzo 3,5 Ton. ( DX )  
*Light rear tilting raw bodies assembly capacity load 3,5 Tons ( R )*

(Kg.1,610)

**Art. 35-00077/SX** Kit ribaltabile posteriore leggero grezzo 3,5 Ton. ( SX )  
*Light rear tilting raw bodies assembly capacity load 3,5 Tons ( R )*

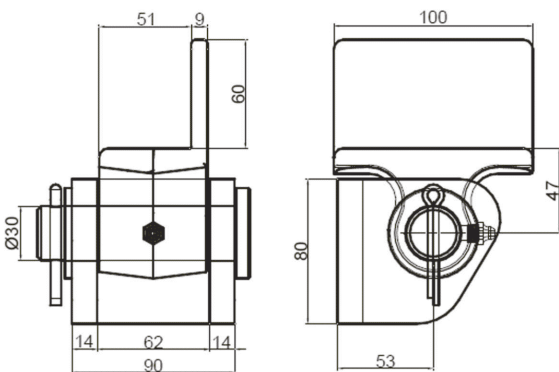

**Art. 35-00078/DX** Kit ribaltabile posteriore pesante grezzo 5 Ton. ( DX )  
*Heavy rear tilting raw bodies assembly capacity load 5 Tons ( R )*

(Kg.4,315)

**Art. 35-00078/SX** Kit ribaltabile posteriore pesante grezzo 5 Ton. ( SX )  
*Heavy rear tilting raw bodies assembly capacity load 5 Tons ( R )*

